

32" zeroEDGE Bottom Outlet Channel Drain Body

Model #: 88232-

FEATURES:

- 304 stainless steel construction
- 2" bottom outlet
- Nominal Size: 32"
- No sub drain required
- Easy install design
- Available in BSS ONLY, as body is not visible
- JACLO grates sold separately



AVAILABLE FINISHES:

Brushed Stainless (BSS)

SPECIFICATION DRAWING:

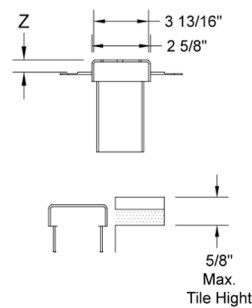
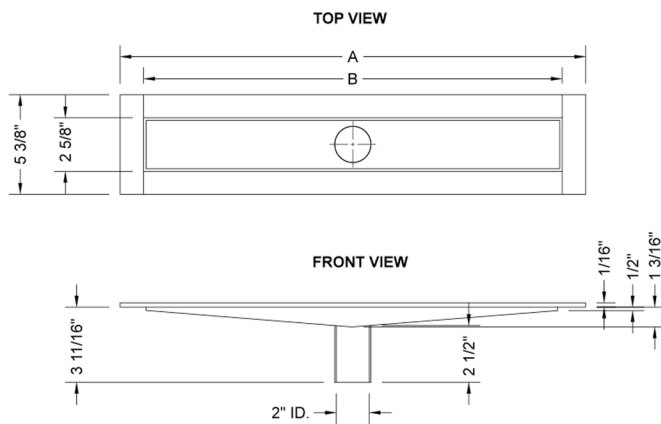

PART. #	DESCRIPTION	BOTTOM OUTLET SHOWER CHANNEL BODY ONLY		TILE HEIGHT ABOVE FLANGE (Grate Height)	
		A	B	Z Min.	Z Max.
88224-XXX	ZERO EDGE BOTTOM OUTLET	25 3/8"	22 3/8"	9/16"	1"
88232-XXX	ZERO EDGE BOTTOM OUTLET	33"	30 1/4"	9/16"	1"
88236-XXX	ZERO EDGE BOTTOM OUTLET	36 7/8"	34 1/4"	11/16"	1 1/8"
88242-XXX	ZERO EDGE BOTTOM OUTLET	44 3/4"	42 1/8"	9/16"	1"
88248-XXX	ZERO EDGE BOTTOM OUTLET	48 3/4"	46"	9/16"	1"
88260-XXX	ZERO EDGE BOTTOM OUTLET	60 1/2"	57 7/8"	5/8"	1 1/16"

COMPLIANCES:

Complies with: ASME A112.18.2-2015/CSA B125.2-15