

## 36" Bottom Outlet Channel Drain Body

Model #: 87236-

### FEATURES:

- 304 stainless steel construction
- 2" bottom outlet
- Nominal Size: 36"
- Complete with adjustable legs for ease of installation
- Use of JACLO sub drain may be required
- JACLO grates sold separately
- Standard finishes: BSS & PSS. Additional finishes available: BKN, JG, PB, PG, SG, SB, ORB, MBK, BU, SDB, WH, TB, EB. Call for pricing and availability



### AVAILABLE FINISHES:

Polished Stainless (PSS)    Brushed Stainless (BSS)

### SPECIFICATION DRAWING:

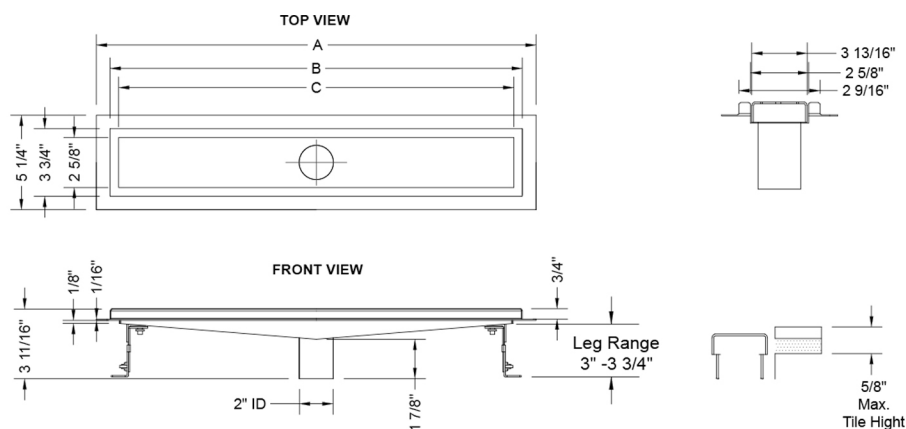

BOTTOM OUTLET SHOWER CHANNEL BODY ONLY				
PART. #	DESCRIPTION	A	B	C
87224-XXX	BOTTOM OUTLET	25 1/8"	23 1/2"	22 3/8"
87232-XXX	BOTTOM OUTLET	33"	31 3/8"	30 1/4"
87236-XXX	BOTTOM OUTLET	36 15/16"	35 5/16"	34 1/4"
87242-XXX	BOTTOM OUTLET	44 13/16"	43 1/4"	42 1/16"
87248-XXX	BOTTOM OUTLET	48 3/4"	47 3/16"	46"
87260-XXX	BOTTOM OUTLET	60 5/8"	58 15/16"	57 7/8"

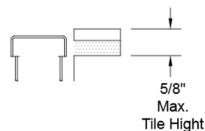
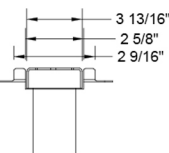

### COMPLIANCES:

Complies with: ASME A112.18.2-2015/CSA B125.2-15