

Installation based on barn door application where doors are hung on the **OUTSIDE** of the room.

- Install Lock Inside the Jamb Wall behind the barn door
- Install Trim Plate on the Jamb Wall facing the opening
- Install Strike with an emergency release on the Barn Door.
- Adjustable Strike for door thickness from 1-3/8" to 2-1/4". Thick Door Kits Available.

Wall Thickness:

LOCK BOLT NO.	BACKSET	WALL THICKNESS	TYPICAL WALL STUDS
BD4214	2-1/4"	4"+	2 x 4
BD4312	3-1/2"	6-1/2"+	2 x 6

BD4000 Series Privacy Barn Door Lock Set Parts List: (With Face Fixing Trim Plate)

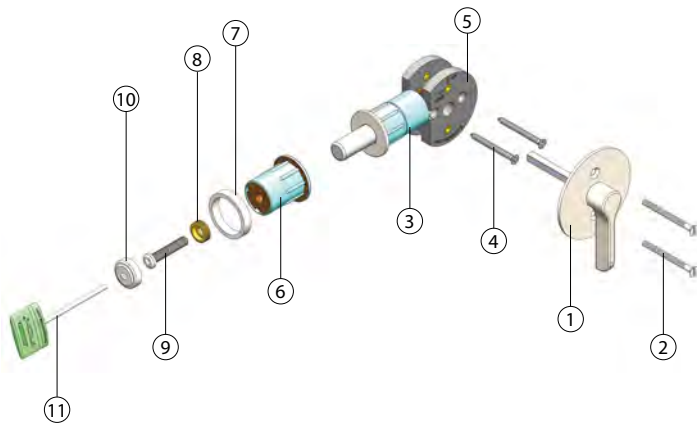

Items	No.	Parts Description	Function
			Privacy
Trim Parts	1	Face Fixing Trim with spindle	1EA
	2	M4 x 50 Slotted Head Screws	2EA
Lock	3	Barn Door Lock	1EA
	4	Ø 4 x 40 Wood Screws	2EA
	5	Lock Bracket	1EA
Strike	6	Dust Proof Strike	1EA
	7	Washer	2EA
	8	Sleeve	1EA
	9	Hollow Screw	1EA
Others	10	Decorative Cap	1EA
	11	Emergency Key	1EA
	-	Door Prep Template	1EA
	-	Installation Instruction	1EA

Wall Conditions and Tools Suggestion

Most of the drywall will have corner bead in steel or vinyl; it's strongly recommended to use **Hole Saw** to cut the holes for installing locks and trim plates. Hole Saw for steel will also help cutting through any screws inside drywall or wood stud to make the installation job run faster.

DO NOT USE:
Spade Bit



Recommend to Use:



Stud finder

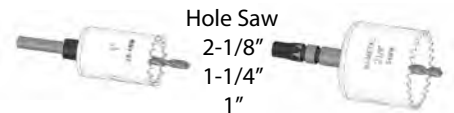

Hole Saw
2-1/8"
1-1/4"
1"

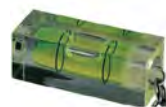

Level



T-Square



1/8" Drill Bit

Step 1. Wall and Door Preparation

A. Drywall Opening

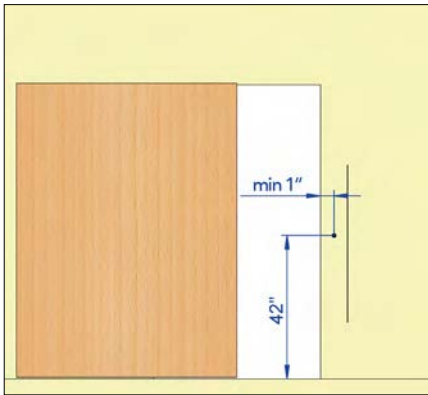

For drywall opening with 1/2" drywall (gypsum board), min. 2" door overlap is needed to install BD4000 privacy lock. The lock bore center must be at least 1" from wall edge; align strike with lock.

Choose center hole location based on your aesthetic preference, so long as it is at least 1" from the edge.

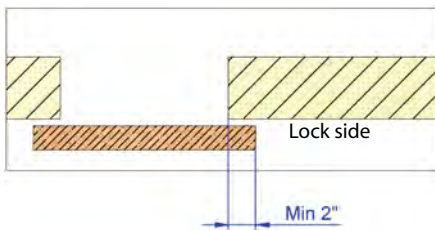

B. Opening with Casing greater than 1-5/8"

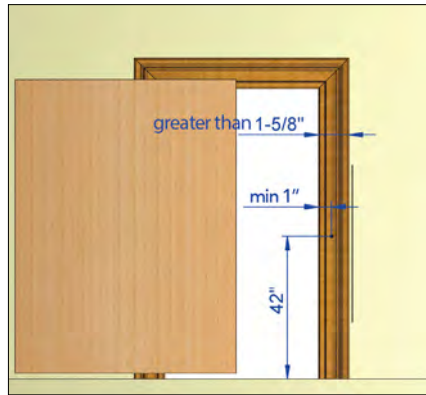

Choose center hole location based on your aesthetic preference, so long as it is at least 1" from the edge.

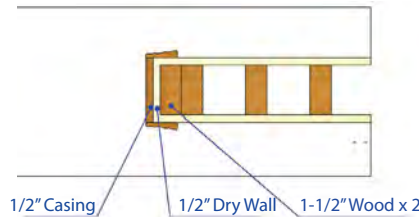

IMPORTANT!

CHECK DOOR OVERLAP DISTANCE

- While door is fully closed, measure overlap on side where lock is to be installed.
- For casing less than 1-5/8", door overlap must be at least 3". Align strike with lock.

C. Opening with Casing less than 1-5/8"

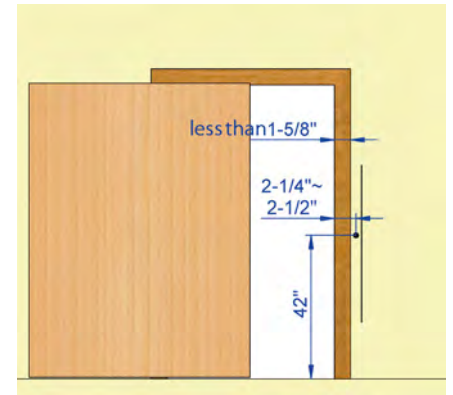

Do not install lock on casing that is less than 1-5/8" wide. Drill lock bore at least 2-1/4" from edge. For this type of installation, door overlap must be at least 3". Align strike with lock.

! If lock bore center location is 2-1/8" or more from edge of opening, use stud finder to ensure there are at least two studs stacked behind lock bore center. Extended spindle and fixing screws may be required. Contact INOX™ to order an extension kit.

Step 2. Prep Trim Bore – On the Jamb

2.1) Verify wall thickness to ensure you have correct lock and backset

Wall Thickness	Stud Size	Item No.	Backset
4"+	2" x 4"	* BD4214	2-1/4"
6-1/2"+	2" x 6"	** BD4312	3-1/2"

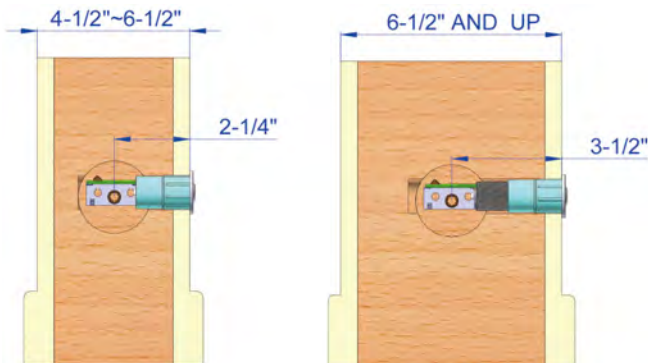

Minimum Wall Thickness:

* BD4214 - minimum thickness 4"

** BD4312 - minimum thickness 6-1/2"

No maximum thickness for either lock.

2.2) Remove Barn Door.

Use template to mark pilot hole.

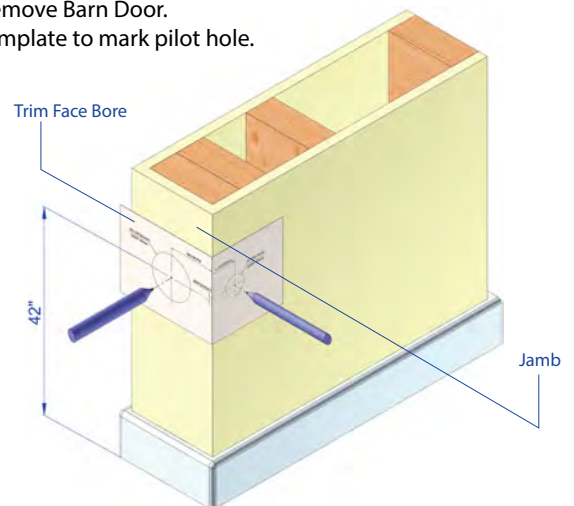

IMPORTANT!

The bore hole on the Jamb side is offset 3.5mm (approximately 1/8") lower than wall-side bore.

Step 2. Prep Trim Bore – On the Jamb (Cont.)

TIP: Before drilling, cover area around the bore hole with masking tape to prevent the drywall from chipping or cracking.

2.3) With a 2-1/8" hole saw, drill on Jamb side in accordance with following steps.

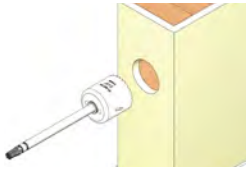

Without Casing:

- Drill through drywall approx. 1/2" to locate first wood stud.
- Continue drilling 1/2" into the stud.

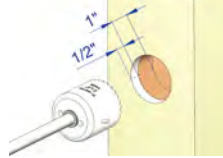

IMPORTANT!

Do Not exceed depth of wood stud when drilling. Minimum 1/4" or thicker wood backing is required to support the lock.

For drywall openings protected with steel corner beads, use metal hole saw for cleaner and faster installation.

With Casing 1-5/8" or wider:

- Drill through casing and drywall approximately 1" to locate the first wood stud.
- Continue drilling 1" deep into stud.

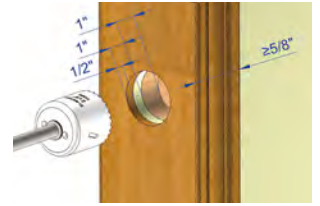

With Casing less than 1-5/8":

- Drill through casing and drywall approximately 1" deep to locate the first wood stud.
- Continue drilling 1-3/4" deep into the stud. This will give you a 2-1/4" deep bore to accommodate the lock installed next to casing.



NOTE: In step 2.3, if there is a gap between the drywall and the stud, measure the distance and add to the bore hole depth. Hole depth must accommodate lock barrel preparation in Step 4. You can deepen trim bore as needed after that step.

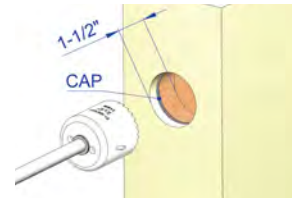

Step 3. Prep Lock Bore

- Double check lock bore distance from Step 1. Refer to template markings to ensure both lock and strike pilot holes are within door overlap requirements. Keep 3/8" safety margin to edges.

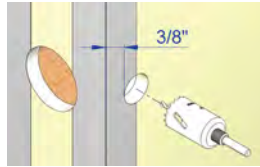

- Dry Wall or Flat Casing opening; Use a 1" hole saw to cut lock bore hole to depth as shown in chart.



- For moulded casing with an uneven surface:

- At pilot center mark, use 1-1/4" hole saw to drill to a depth of 3/8"
- Then, use 1" hole saw at same center mark to drill hole to correct bore hole depth.

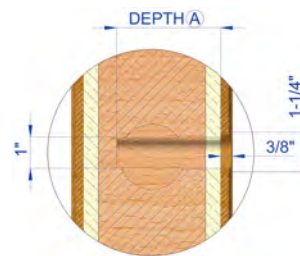
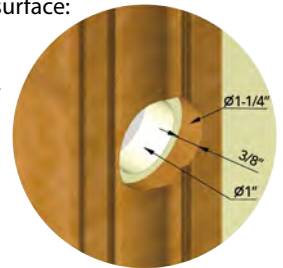

IMPORTANT!

Do Not drill too deep, you may damage the wall on the other side.

Lock Part No.	Lock Backset	Bore Hole Depth
BD4214	2-1/4"	3-1/4"
BD4312	3-1/2"	4-1/2"

Note: Hole Saw for metal should be used for drywall with steel corner bead.

Step 4. Installation of the Lock

- For drywall and casing less than 1-5/8":

- Insert bracket into trim bore
- Insert lock bolt into lock bore and fit into bracket slot.



- For moulded casing with uneven surface

- Insert 1/4" spacer provided with lock into the 1-1/4" recess first
- Insert bracket into trim bore
- Insert lock bolt and spacer into lock bore and fit into bracket slot.

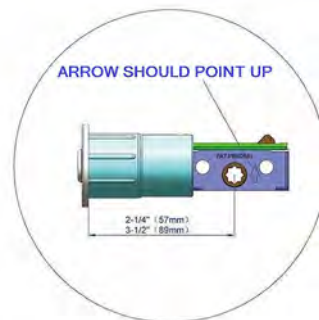

Step 4. Installation of the Lock (Cont.)

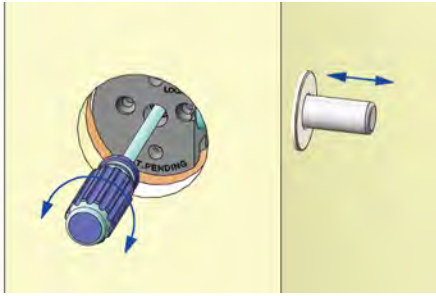

4.4) Ensure spindle hub is at center of trim bore. Use spindle or screw driver to test bolt retraction; if not smooth, trouble-shoot as follows:

- Check 1-3/4" trim bore dimensions
- Ensure hole is free of debris
- Make sure lock bore is perpendicular to trim bore
- Check lock by removing it from bore and throwing the bolt. Adjust wall prep as needed.

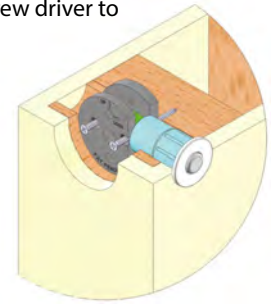

4.5) Fasten the 2 wood screws inside the trim bore hole through lock body and into wood stud.

Step 5. Installation of Face Fixing Trim

5.1) Cut spindle and screw to accommodate wall side back set.



Edge to Lock Center	B	Spindle Length (mm)	L	Screw Length (mm)	H
1"		1-1/4"		13/16"	
1-1/4"		1-1/2"		1-1/16"	
1-1/2"		1-3/4"		1-5/16"	
1-3/4"		2"		1-9/16"	
2"		2-1/4"		1-13/16"	
2-1/4"		2-1/2"		2-1/16"	
2-1/2"		2-3/4"		2-5/16"	

5.2) Insert trim into spindle hole. Use thumbturn to test lock bolt movement.



5.3) Fasten trim screws until trim is tight to jamb surface. NOTE: Do not over tighten.

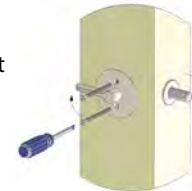

Step 6. Prep and Install Dust Proof Strike with Emergency Release On Barn Door

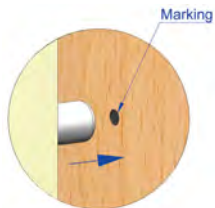

6.1) Move the Barn Door to the Closed position; throw the lock bolt to mark the exact strike center position. Make sure this location is min. 1" to the edge of the door.

6.2) Using the strike center position as a guide, drill a pilot hole through the door with a 1/8" bit from strike side.

With the pilot hole as guide, use a 1" diameter hole saw to drill a 1-1/4" deep hole.

DO NOT drill through the door.

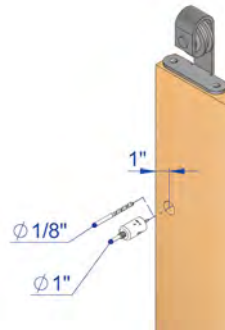

6.3) Using your pilot hole as a guide, use a 1/4" bit to drill a hole from outside through to connect with the strike bore.

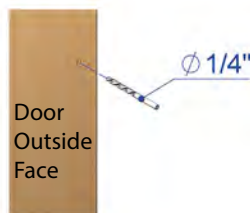
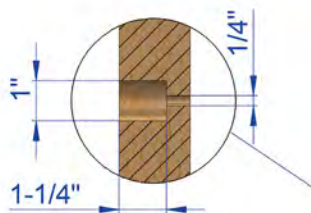

Note: Standard Barn Door to wall clearance is approximately 3/8" to 1/2". Install additional spacer as needed behind the strike faceplate if the door to wall clearance is over 1/2". Additional spacers can support maximum clearance of 3/4" between door and wall.

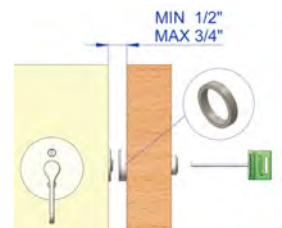

6.4) Install the 1" dust-proof strike with the 1/4" release screws on the outside.



6.5) Cut break-away screw to appropriate door thickness. DO NOT OVER TIGHTEN

Door Thickness	Length without Spacer	Length with Spacer
1-3/8"	11/16"	15/16"
1-3/4"	1-3/32"	1-5/16"

6.6) Install break away screw and tighten with allen wrench. DO NOT OVER TIGHTEN. Hand screw on decorative cap

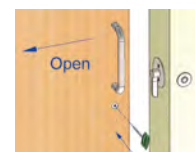

6.7) Use release key (provided with lock set) to push through center hole on release to push lock bolt back and unlock door.