

The Fixed Flange Series & Side Outlet Series are intended for use with the following waterproofing methods:

- Liquid Waterproofing
- Fabric Waterproofing

Made in the U.S.A.

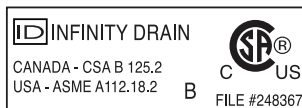

Infinity Drain • 18 Secatoag Avenue, Port Washington, New York 11050
Phone 516.767.6786 • Fax 516.740.3066 • www.InfinityDrain.com

Dimension are subject to Manufacturers tolerance and change without notice. We can assume no responsibility for use of superseded or void data.

Las dimensiones están sujetos a la tolerancia del fabricante y cambio sin previo aviso. No podemos asumir ninguna responsabilidad por el uso de datos a sustituir los nulos.

Fixed Flange (FF) Series Components:

SS=Stainless Steel

FFED 25 Series	
EA 6532	32" SS Grate
EA 6536	36" SS Grate
EA 6542	42" SS Grate
EA 6548	48" SS Grate
EA 6560	60" SS Grate
FC 6532	32" SS Fixed Channel
FC 6536	36" SS Fixed Channel
FC 6542	42" SS Fixed Channel
FC 6548	48" SS Fixed Channel
FC 6560	60" SS Fixed Channel
CI 2532	32" SS Channel Insert
CI 2536	36" SS Channel Insert
CI 2542	42" SS Channel Insert
CI 2548	48" SS Channel Insert
CI 2560	60" SS Channel Insert

FFDG 25 Series	
DA 6532	32" SS Grate
DA 6536	36" SS Grate
DA 6542	42" SS Grate
DA 6548	48" SS Grate
DA 6560	60" SS Grate
FC 6532	32" SS Fixed Channel
FC 6536	36" SS Fixed Channel
FC 6542	42" SS Fixed Channel
FC 6548	48" SS Fixed Channel
FC 6560	60" SS Fixed Channel
CI 2532	32" SS Channel Insert
CI 2536	36" SS Channel Insert
CI 2542	42" SS Channel Insert
CI 2548	48" SS Channel Insert
CI 2560	60" SS Channel Insert

FFMN 25 Series	
MA 6532	32" SS Grate
MA 6536	36" SS Grate
MA 6542	42" SS Grate
MA 6548	48" SS Grate
MA 6560	60" SS Grate
FC 6532	32" SS Fixed Channel
FC 6536	36" SS Fixed Channel
FC 6542	42" SS Fixed Channel
FC 6548	48" SS Fixed Channel
FC 6560	60" SS Fixed Channel
CI 2532	32" SS Channel Insert
CI 2536	36" SS Channel Insert
CI 2542	42" SS Channel Insert
CI 2548	48" SS Channel Insert
CI 2560	60" SS Channel Insert

FFAS 25 Series	
SA 6532	32" SS Grate
SA 6536	36" SS Grate
SA 6542	42" SS Grate
SA 6548	48" SS Grate
SA 6560	60" SS Grate
FC 6532	32" SS Fixed Channel
FC 6536	36" SS Fixed Channel
FC 6542	42" SS Fixed Channel
FC 6548	48" SS Fixed Channel
FC 6560	60" SS Fixed Channel
CI 2532	32" SS Channel Insert
CI 2536	36" SS Channel Insert
CI 2542	42" SS Channel Insert
CI 2548	48" SS Channel Insert
CI 2560	60" SS Channel Insert

FFED 65 Series	
EA 6524	24" SS Grate
EA 6532	32" SS Grate
EA 6536	36" SS Grate
EA 6542	42" SS Grate
EA 6548	48" SS Grate
EA 6560	60" SS Grate
FC 6524	24" SS Fixed Channel
FC 6532	32" SS Fixed Channel
FC 6536	36" SS Fixed Channel
FC 6542	42" SS Fixed Channel
FC 6548	48" SS Fixed Channel
FC 6560	60" SS Fixed Channel
HF 2	2" Hair Strainer

FFDG 65 Series	
DA 6532	32" SS Grate
DA 6536	36" SS Grate
DA 6542	42" SS Grate
DA 6548	48" SS Grate
DA 6560	60" SS Grate
FC 6532	32" SS Fixed Channel
FC 6536	36" SS Fixed Channel
FC 6542	42" SS Fixed Channel
FC 6548	48" SS Fixed Channel
FC 6560	60" SS Fixed Channel
HF 2	2" Hair Strainer

FFMN 65 Series	
MA 6532	32" SS Grate
MA 6536	36" SS Grate
MA 6542	42" SS Grate
MA 6548	48" SS Grate
MA 6560	60" SS Grate
FC 6532	32" SS Fixed Channel
FC 6536	36" SS Fixed Channel
FC 6542	42" SS Fixed Channel
FC 6548	48" SS Fixed Channel
FC 6560	60" SS Fixed Channel
HF 2	2" Hair Strainer

FFAS 65 Series	
SA 6524	24" SS Grate
SA 6532	32" SS Grate
SA 6536	36" SS Grate
SA 6542	42" SS Grate
SA 6548	48" SS Grate
SA 6560	60" SS Grate
FC 6524	24" SS Fixed Channel
FC 6532	32" SS Fixed Channel
FC 6536	36" SS Fixed Channel
FC 6542	42" SS Fixed Channel
FC 6548	48" SS Fixed Channel
FC 6560	60" SS Fixed Channel
HF 2	2" Hair Strainer

FFAS 125 Series	
SA 12532	32" SS Grate
SA 12536	36" SS Grate
SA 12542	42" SS Grate
SA 12548	48" SS Grate
SA 12560	60" SS Grate
FC 12532	32" SS Fixed Channel
FC 12536	36" SS Fixed Channel
FC 12542	42" SS Fixed Channel
FC 12548	48" SS Fixed Channel
FC 12560	60" SS Fixed Channel

FFTIF 65 Series	
LA 6524	24" SS Grate
LA 6532	32" SS Grate
LA 6536	36" SS Grate
LA 6542	42" SS Grate
LA 6548	48" SS Grate
LA 6560	60" SS Grate
FC 6524	24" SS Fixed Channel
FC 6532	32" SS Fixed Channel
FC 6536	36" SS Fixed Channel
FC 6542	42" SS Fixed Channel
FC 6548	48" SS Fixed Channel
FC 6560	60" SS Fixed Channel
HF 2	2" Hair Strainer

Note: Installer must verify all rough-in dimensions prior to installation and consult local and national codes. Conformity and compliance to local and national codes are the responsibility of the installer.

Tenga en cuenta: Instalador debe comprobar todas las dimensiones en las partes previa a la instalación y consultar localmente y nacionalmente los códigos. La conformidad y el cumplimiento de códigos local y nacional es responsabilidad del instalador.

Side Outlet (FT) Series Components:

SS=Stainless Steel

FTED 25 Series	
EA 6532	32" SS Grate
EA 6536	36" SS Grate
EA 6542	42" SS Grate
EA 6548	48" SS Grate
EA 6560	60" SS Grate
OC 6532	32" SS Fixed Channel
OC 6536	36" SS Fixed Channel
OC 6542	42" SS Fixed Channel
OC 6548	48" SS Fixed Channel
OC 6560	60" SS Fixed Channel
CI 2532	32" SS Channel Insert
CI 2536	36" SS Channel Insert
CI 2542	42" SS Channel Insert
CI 2548	48" SS Channel Insert
CI 2560	60" SS Channel Insert

FTDG 25 Series	
DA 6532	32" SS Grate
DA 6536	36" SS Grate
DA 6542	42" SS Grate
DA 6548	48" SS Grate
DA 6560	60" SS Grate
OC 6532	32" SS Fixed Channel
OC 6536	36" SS Fixed Channel
OC 6542	42" SS Fixed Channel
OC 6548	48" SS Fixed Channel
OC 6560	60" SS Fixed Channel
CI 2532	32" SS Channel Insert
CI 2536	36" SS Channel Insert
CI 2542	42" SS Channel Insert
CI 2548	48" SS Channel Insert
CI 2560	60" SS Channel Insert

FTMN 25 Series	
MA 6532	32" SS Grate
MA 6536	36" SS Grate
MA 6542	42" SS Grate
MA 6548	48" SS Grate
MA 6560	60" SS Grate
OC 6532	32" SS Fixed Channel
OC 6536	36" SS Fixed Channel
OC 6542	42" SS Fixed Channel
OC 6548	48" SS Fixed Channel
OC 6560	60" SS Fixed Channel
CI 2532	32" SS Channel Insert
CI 2536	36" SS Channel Insert
CI 2542	42" SS Channel Insert
CI 2548	48" SS Channel Insert
CI 2560	60" SS Channel Insert

FTAS 25 Series	
SA 6532	32" SS Grate
SA 6536	36" SS Grate
SA 6542	42" SS Grate
SA 6548	48" SS Grate
SA 6560	60" SS Grate
OC 6532	32" SS Fixed Channel
OC 6536	36" SS Fixed Channel
OC 6542	42" SS Fixed Channel
OC 6548	48" SS Fixed Channel
OC 6560	60" SS Fixed Channel
CI 2532	32" SS Channel Insert
CI 2536	36" SS Channel Insert
CI 2542	42" SS Channel Insert
CI 2548	48" SS Channel Insert
CI 2560	60" SS Channel Insert

FTED 65 Series	
EA 6524	24" SS Grate
EA 6532	32" SS Grate
EA 6536	36" SS Grate
EA 6542	42" SS Grate
EA 6548	48" SS Grate
EA 6560	60" SS Grate
OC 6524	24" SS Fixed Channel
OC 6532	32" SS Fixed Channel
OC 6536	36" SS Fixed Channel
OC 6542	42" SS Fixed Channel
OC 6548	48" SS Fixed Channel
OC 6560	60" SS Fixed Channel

FTDG 65 Series	
DA 6532	32" SS Grate
DA 6536	36" SS Grate
DA 6542	42" SS Grate
DA 6548	48" SS Grate
DA 6560	60" SS Grate
OC 6532	32" SS Fixed Channel
OC 6536	36" SS Fixed Channel
OC 6542	42" SS Fixed Channel
OC 6548	48" SS Fixed Channel
OC 6560	60" SS Fixed Channel

FTMN 65 Series	
MA 6532	32" SS Grate
MA 6536	36" SS Grate
MA 6542	42" SS Grate
MA 6548	48" SS Grate
MA 6560	60" SS Grate
OC 6532	32" SS Fixed Channel
OC 6536	36" SS Fixed Channel
OC 6542	42" SS Fixed Channel
OC 6548	48" SS Fixed Channel
OC 6560	60" SS Fixed Channel

FTAS 65 Series	
SA 6524	24" SS Grate
SA 6532	32" SS Grate
SA 6536	36" SS Grate
SA 6542	42" SS Grate
SA 6548	48" SS Grate
SA 6560	60" SS Grate
OC 6524	24" SS Fixed Channel
OC 6532	32" SS Fixed Channel
OC 6536	36" SS Fixed Channel
OC 6542	42" SS Fixed Channel
OC 6548	48" SS Fixed Channel
OC 6560	60" SS Fixed Channel

FTTIF 65 Series	
LA 6524	24" SS Grate
LA 6532	32" SS Grate
LA 6536	36" SS Grate
LA 6542	42" SS Grate
LA 6548	48" SS Grate
LA 6560	60" SS Grate
OC 6524	24" SS Fixed Channel
OC 6532	32" SS Fixed Channel
OC 6536	36" SS Fixed Channel
OC 6542	42" SS Fixed Channel
OC 6548	48" SS Fixed Channel
OC 6560	60" SS Fixed Channel

Optional Components: (Not Included)

ST 65	Placement Brackets for FF25/FF65 Series
ST 125	Placement Brackets for FF125 Series

Note: Installer must verify all rough-in dimensions prior to installation and consult local and national codes. Conformity and compliance to local and national codes are the responsibility of the installer.

Tenga en cuenta: Instalador debe comprobar todas las dimensiones en las partes previa a la instalación y consultar localmente y nacionalmente los códigos. La conformidad y el cumplimiento de códigos local y nacional es responsabilidad del instalador.

Fixed Flange (FF) Series:

Drain can be adjusted upward for an additional 1/2" in height.

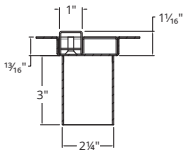
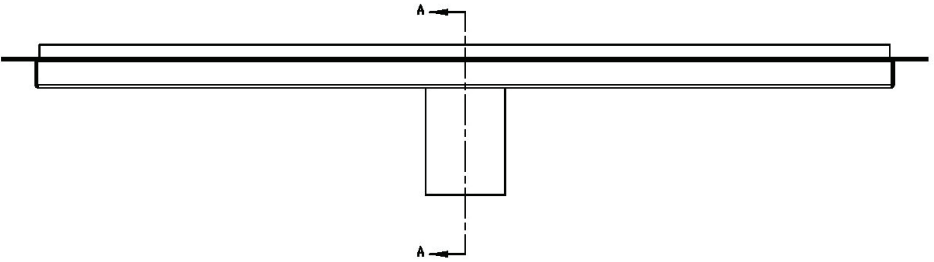

Section A-A
FFED 25, FFDG 25,
FFMN 25, FFAS 25

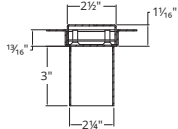

Section A-A
FFED 65, FFDG 65,
FFMN 65, FFAS 65

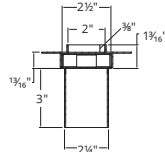

Section A-A
FFTIF 65

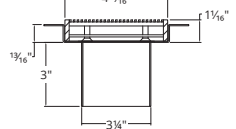

Section A-A
FFAS 125

Side Outlet (FT) Series:

Drain can be adjusted upward for an additional 1/2" in height.

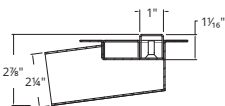
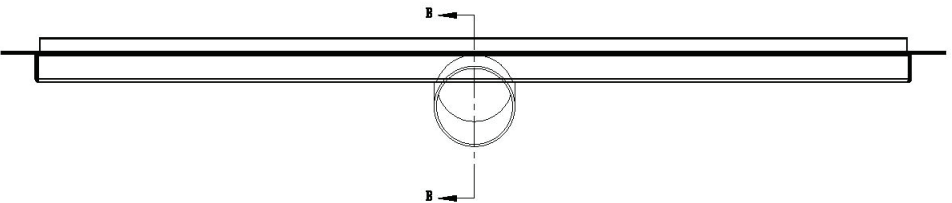

Section B-B
FTED 25, FTDG 25,
FTMN 25, FTAS 25

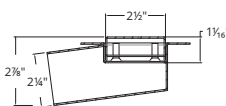

Section B-B
FTED 65, FTDG 65,
FTMN 65, FTAS 65

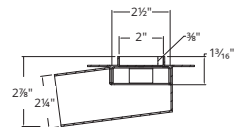

Section B-B
FFTIF 65

FIXED FLANGE (FF) SERIES

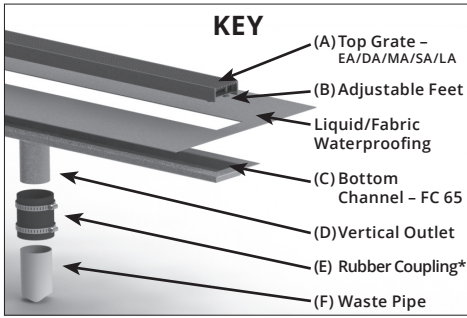

Installation

1. Locate the waste line position. Typically linear drains span a dimension from wall to wall, against a wall or at a shower entrance.

Note: When drain install is required to be flush against the finished wall, backer board will install over the 1" flange of the drain body.

FF (Fixed Flange Series) only:

2. Spread a preliminary mortar bed across the intended drain location. Set drain into mortar bed. Connect the outlet section (D) to the existing waste pipe (F) via 2" no hub connection using a 2" DWV no hub rubber coupling (E). Allow stainless steel channel (C) to sit onto subfloor.

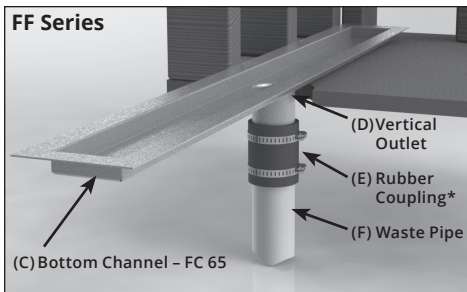

FT (Side Outlet Series) only:

2. Connect the outlet section (D) to the existing waste pipe (F) via 2" no hub connection using a 2" DWV no hub rubber coupling (E). Be sure to use integrated drain supports to support the stainless steel channel (C) at the desired height.

SIDE OUTLET (FT) SERIES

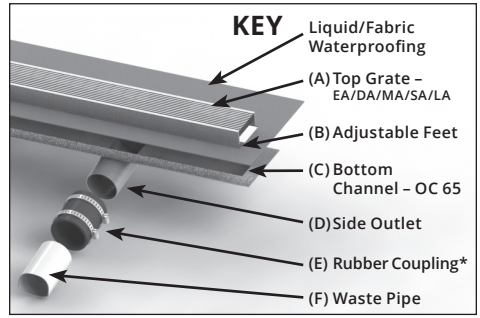

Instalación

1. Localize la posición de la línea de residuos. Típicamente los drenajes lineales extienden a una dimensión desde pared a pared, contra una pared, o en una entrada del baño.

Tenga en cuenta: Cuando el drenaje se instale es necesario que este contra la pared terminada, placa de cemento se instalara sobre 1" brida del drenaje.

Solo FF (Fixed Flange Series):

2. Conecte la sección de salida (D) a la tubería existente (F) vía 2" conexión sin concentrador usando 2" DWV goma de acoplamiento (E). Permita el canal de acero (C) sentarse en el subsuelo.

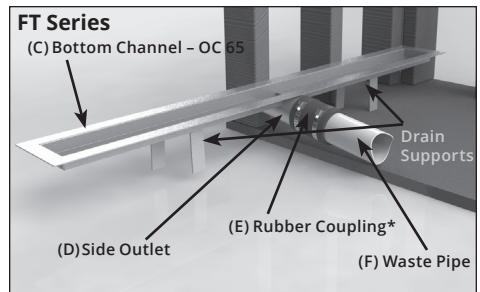

Solo FT (Side Outlet Series):

2. Conecte la sección de salida (D) a la tubería de residuos existente (F) a través de 2" sin conexión concentrado usando DWV ningún acoplamiento elástico (E). Asegúrese de utilizar un drenaje integrado para soportar el canal de acero (C) a la longitud desea.

Note: When floor pitch is needed to begin at a zero level, determine the length of the channel (B) less the 1" flange around it's perimeter. Cut a hole in the subfloor to the measured dimensions at the desired location. Place the ST65/ST125 Placement Brackets (Optional Component) in the newly created hole and screw into subfloor. Recess the stainless steel channel (C) into the subfloor and bracket. Allow the 1" flange to sit onto the subfloor.

Tenga en cuenta: Cuando el piso sea pitch es necesario que comienza a un cero nivel, determine la longitud del canal (B) menos de 1" alrededor del perímetro. Corte un agujero en el subsuelo a la dimensión medida de la ubicación deseada. Colocar el ST65/ST125 soportes de colocación (Componentes Opcionales) en el recién agujero y atornille en el subsuelo. Empotrar el canal de acero (C) en el subsuelo y soporte. Permita el 1"brida que este sentado en el subsuelo.

Limited waste pipe access:

Measure the distance from the top of the existing waste line to the top of the subfloor. Ensure that the outlet section (D) is at minimum of 2" less than this dimension, cut the 3" length of the outlet section (D) if necessary. **DO NOT** remove more than 2" from the outlet section. Determine the distance from the bottom of the outlet section (D) to the top of the existing waste pipe (F). Cut a 2" PVC or ABS pipe to a length 1/8" less than this dimension. Bond the 2" PVC/ABS pipe to a 2" DWV PVC/ABS coupling using PVC/ABS primer and cement. Connect the other end of the 2" PVC/ABS pipe to the outlet section (D) via a 2" DWV no hub rubber coupling. Bond the free end of the 2" pipe and coupling assembly to the existing waste pipe using PVC/ABS primer and cement.

3. Spread a mortar bed across the intended shower area and ensure the drain channel (C) is level. Back fill region under the channel 1" flange so that pitch begins level to the edge of the stainless steel channel (C). Pitch this bed one plane towards the drain body.

4. When mortar layer is dry, perform necessary waterproofing (liquid membrane or fabric sheet membrane) as per local code and manufacturers' instructions. Paint or bond waterproofing directly to the channels flange.

5. After waterproofing is completely dry, lay thinset and finishing material. Finish material on to the channel flange. **DO NOT** allow tile to finish over the depth of the channel.

Límite acceso de tubería de residuos:

Medir la distancia desde la parte superior de la línea de residuos existentes a la parte superior del subsuelo. Asegúrese que la sección de salida (D) este mínimo 2" menos de la dimensión, corte 3" de largo de la sección de salida (D) si es necesario. **NO REMUEVE** más de 2.5" de la sección de salida. Determine la distancia desde debajo de la sección de salida (D) a la parte superior de la tubería existente (F). Corte un tubo de PVC o ABS a 2" a lo largo 1/8" menos de la dimensión. Una la 2" de tubería de PVC/ABS a 2" DWV PVC/ABS de acoplamiento usando PVC/ABS primer y cemento. Conecte la otra parte de 2" de tubería PVC/ABS a la sección de salida (D) vía a 2" DWV sin ningún acoplamiento elástico. Una la parte final de la 2" de la tubería y la asamblea de acoplamiento a la existencia de la tubería de residuos usando PVC/ABS primer y cemento.

3. Extienda mortero a través del baño previsto y asegure que el canal (C) este anivelado. Rellene la región baja del canal de 1" para que comience a brear a nivel del borde del canal de acero (C). Bree esto a un plano hacia el drenaje.

4. Cuando el motero este seco, realice la necesaria impermeabilización (Membrana de liquidó o membrana de tejido) según las reglas locales y las instrucciones del fabricante. Pinte o enlace la impermeabilización directamente al reborde del canal.

5. Después de que la impermeabilización se seque por completo, colocar el thinset y el material terminado. El material terminado hasta el borde del canal. **NO PERMITA o DEJE** que el tile termine encima de la profundidad del canal.

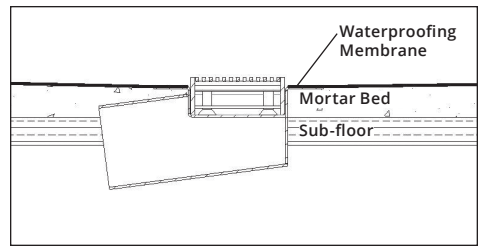
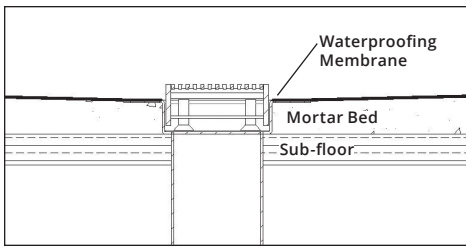

Before finishing material • Antes que el material esté terminado

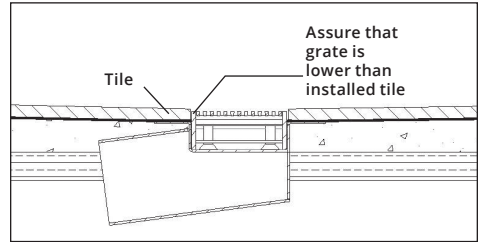
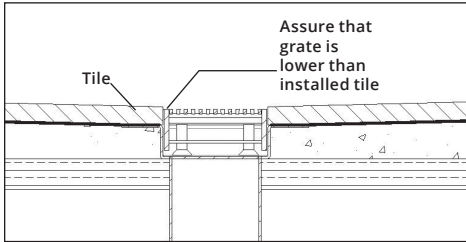

After finishing material • Después que el material esté terminado

6. Place finished top grate (A) into the installed bottom channel (C). Use adjustable feet (B) to raise or lower the top grate to be 1/16" below the finishing material height.

6. Coloque la rejilla superior (A) en la parte inferior del canal instalado (C). Utilicé ajustables pies para levantar o bajar la rejilla a ser 1/16" debajo de la altura del material terminado.

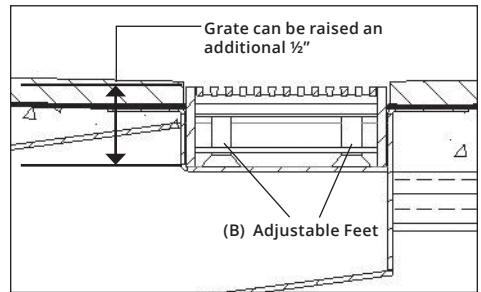
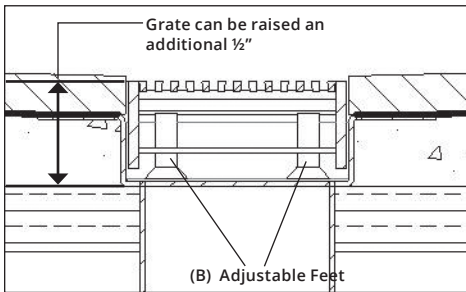

Model	Minimum Height	Maximum Height
FFED25/FFED65/ FFDG25/FFDG65/ FFMN25/FFMN65/ FFAS25/FFAS65/FFAS125	1 ¹ / ₁₆ "	1 ⁹ / ₁₆ "
FFTIF 65	1 ³ / ₁₆ "	1 ¹¹ / ₁₆ "

Model	Minimum Height	Maximum Height
FTED25/FTED65/FTDG25/ FTDG65/FTMN25/ FTMN65/FTAS25/FTAS65/ FTAS125	1 ¹ / ₁₆ "	1 ⁹ / ₁₆ "
FTTIF 65	1 ³ / ₁₆ "	1 ¹¹ / ₁₆ "

7. FFTIF 65/TTIF 65 INSTALL. Spread a layer of mortar into the Tile Insert Frame (TA65), allowing for thinset and finishing material to finish 1/16" above the metal frame. Allow to dry, spread thinset and lay material.

7. FFTIF 65/TTIF 65 INSTALACION. Extender una capa de mortero en Tile Insert Frame (TA65), permitiendo el thinset y material terminado que termine 1/16" arriba del marco del metal. Permita que se seque, extienda thinset y coloca material.

FIXED FLANGE (FF) SERIES

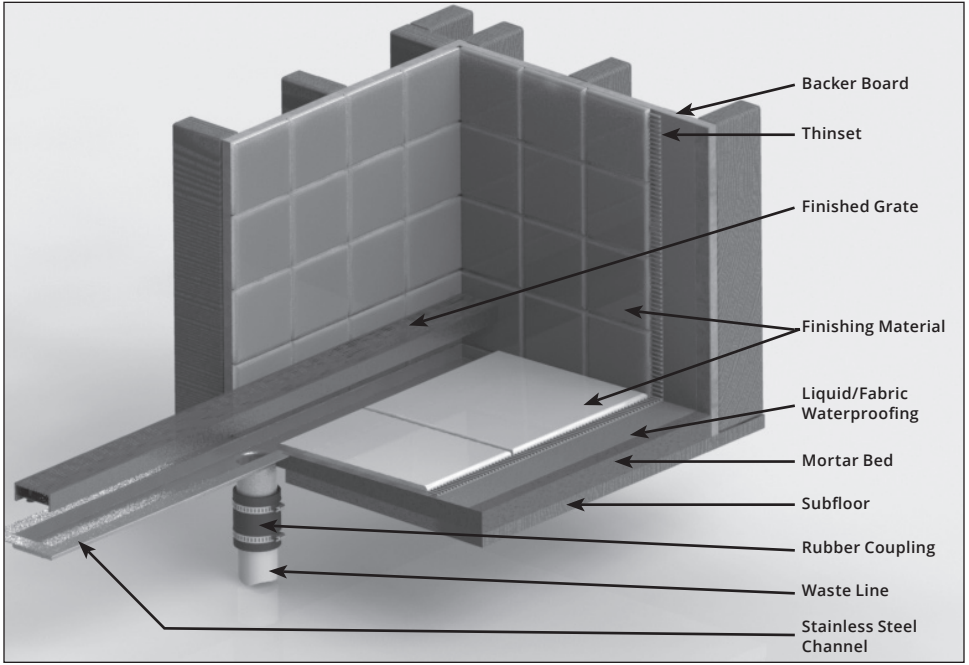

SIDE OUTLET (FT) SERIES

