

A 38 Specifications

ID Infinity Drain

A 38:

- Wedge wire grate for S-AG 38
- 12 gauge, 316 stainless steel
- 3mm wire, 3mm gap

Models (overall dimensions):

- A 3824: 23 7/8" L x 1 1/2" W x 1 9/16" H
- A 3836: 35 7/8" L x 1 1/2" W x 1 9/16" H
- A 3848: 47 7/8" L x 1 1/2" W x 1 9/16" H
- A 3860: 59 7/8" L x 1 1/2" W x 1 9/16" H
- A 3872: 71 7/8" L x 1 1/2" W x 1 9/16" H

Finishes:

- Satin Stainless (SS)
- Polished Stainless (PS)
- Lifetime Oil Rubbed Bronze (ORB)
- Satin Bronze (SB)

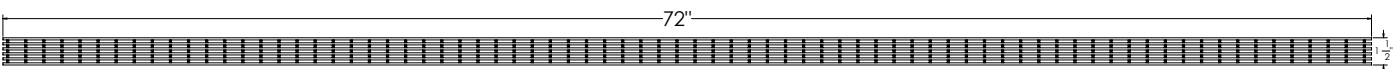
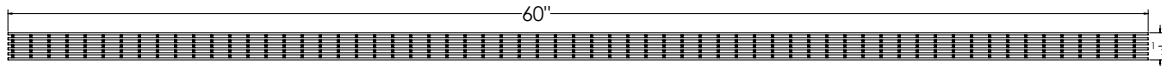
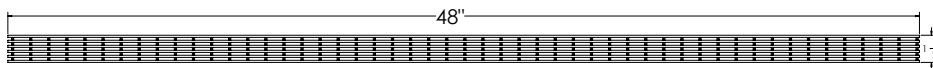
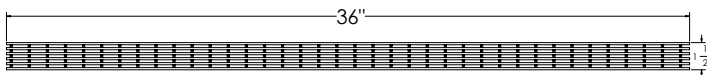
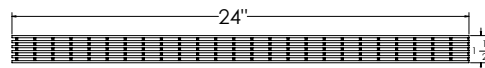
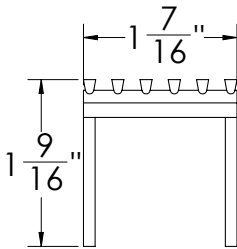
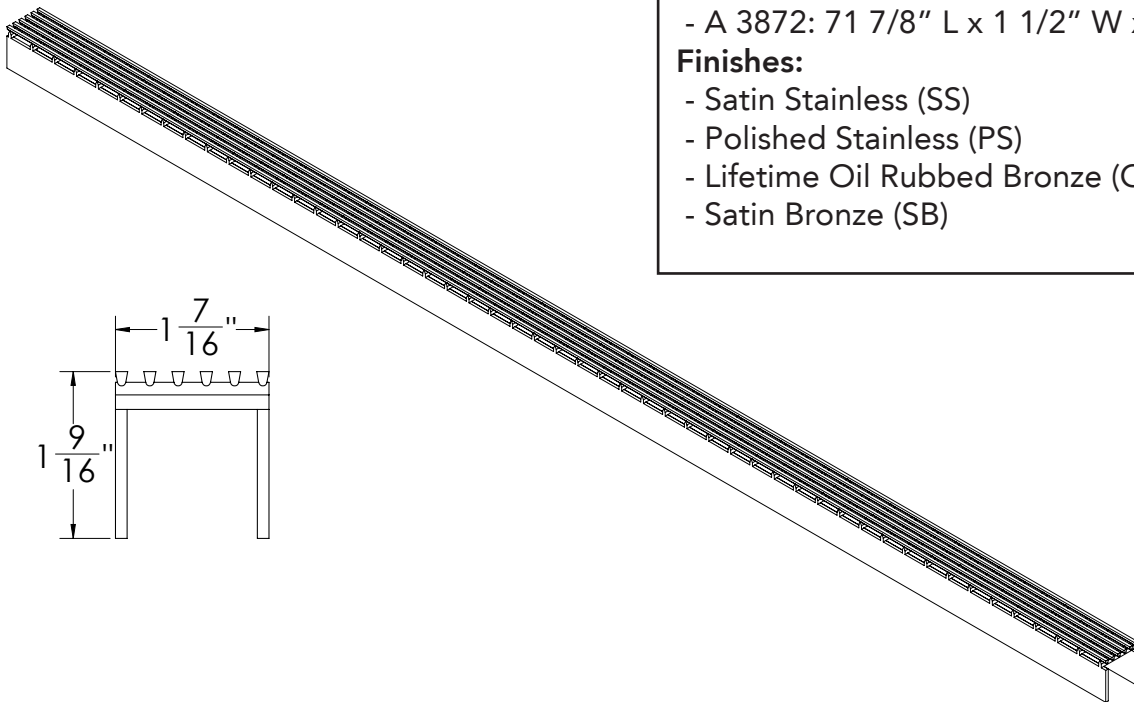

Infinity Drain
18 Secatoag Avenue
Port Washington, NY 11050
Phone: 516.767.6786
Fax: 516.740.3066
www.Infinity Drain.com



NOTE: Installer must verify all rough-in dimensions prior to installation and consult local and national codes. Conformity and compliance to local and national codes are the responsibility of the installer.