

FXAS 125 Series



FXAS 125 | Fixed Length

- 12 gauge 316 Stainless Steel grate and channel
- Pre-pitched channel with "Fixed" lengths and "Fixed" center outlet
- Not site sizeable
- Indoor or outdoor use
- 4" clamp down floor drain with 3" throat (strainer size)
- Uses Hot Mop, Lead Pan, PVC Vinyl Liner, Rubber Liner (Chloraloy™) Copper Pan or Fiberglass waterproofing
- Grate can be removed completely for cleaning
- Flow rate 21 GPM per outlet*

*Flow rate measured at outlet only. Measurement does not account for water in channel or sheeting on shower floor.

Finishes:

- Satin Stainless
- Polished Stainless

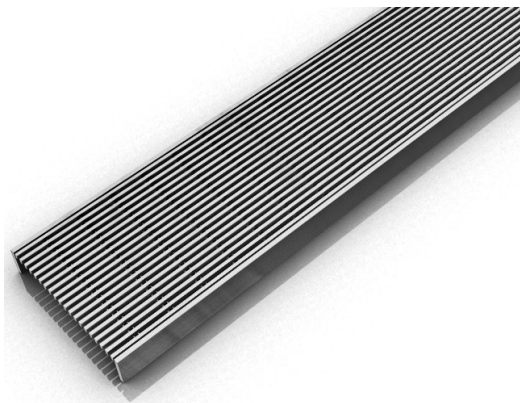

Installation (FX) Fixed

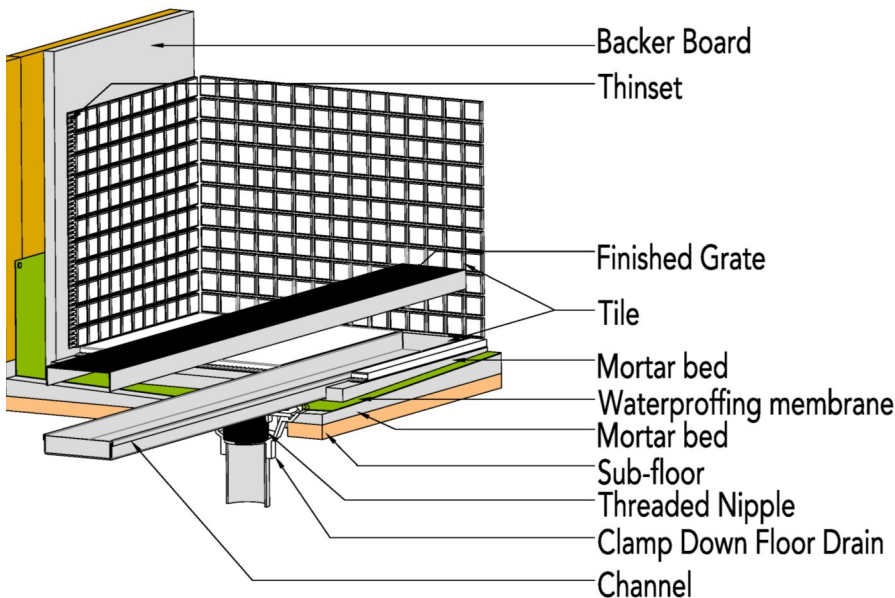

Complete Kits:

- FXAS 12532 32" Complete Kit
- FXAS 12536 36" Complete Kit
- FXAS 12542 42" Complete Kit
- FXAS 12548 48" Complete Kit
- FXAS 12560 60" Complete Kit

Components:

- SA 12532 32" Stainless Steel Grate
- SA 12536 36" Stainless Steel Grate
- SA 12542 42" Stainless Steel Grate
- SA 12548 48" Stainless Steel Grate
- SA 12560 60" Stainless Steel Grate
- XC 12532 32" Stainless Steel Fixed Channel
- XC 12536 36" Stainless Steel Fixed Channel
- XC 12542 42" Stainless Steel Fixed Channel
- XC 12548 48" Stainless Steel Fixed Channel
- XC 12560 60" Stainless Steel Fixed Channel
- TN4A Stainless Steel Threaded Nipple
- CDI 43 Cast Iron Drain Body

Additional Clamp Down Drains:

- CDA 43 Clamp Down Drain ABS
- CDP 43 Clamp Down Drain PVC
- CDIT 43 Clamp Down Drain Cast Iron (Threaded Outlet)
- CDIC 43 Clamp Down Drain Cast Iron (Inside Caulk Outlet)

Optional Components:

- UCP 4 Universal 4" Clamping Plate

Infinity Drain

18 Secatoag Avenue
Port Washington, NY 11050
Phone: 516.767.6786
Fax: 516.740.3066
www.InfinityDrain.com

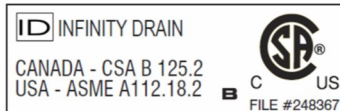

Note: Installer must verify all rough-in dimensions prior to installation and consult local and national codes. Conformity and compliance to local and national codes are the responsibility of the installer.

FXAS 12560 Specifications

ID Infinity Drain

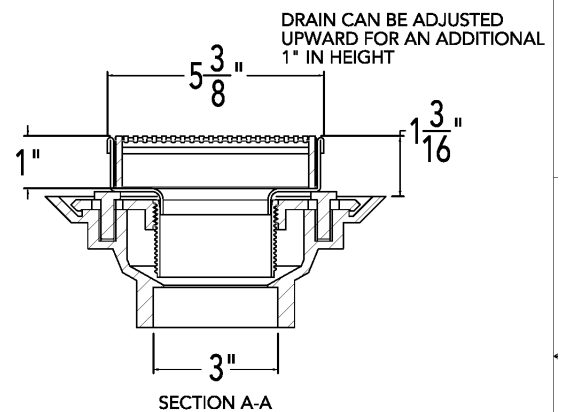
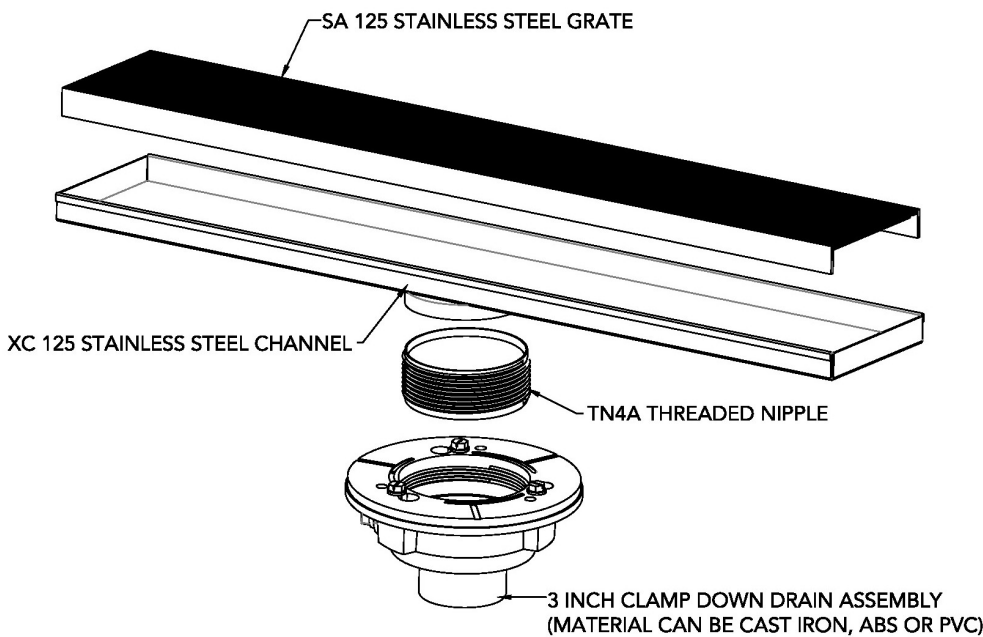
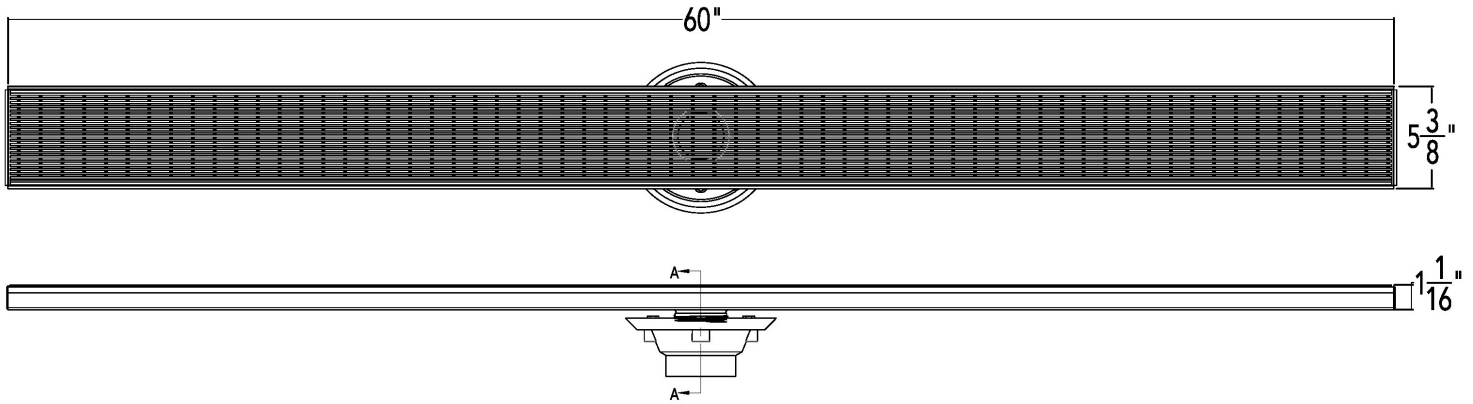

FXAS 12560

60" Complete Kit Includes:

- (60 1/8" l x 5 3/8" w x 1" h)
- 1 - SA 12560 Stainless Steel Grate
- 1 - XC 12560 Fixed Channel
- 1 - TN4A Threaded Nipple
- 1 - CDI 43 Cast Iron Drain Body

Infinity Drain

18 Secatoag Avenue
 Port Washington, NY 11050
 Phone: 516.767.6786
 Fax: 516.740.3066
 www.InfinityDrain.com

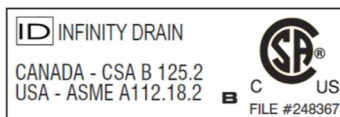

Note: Installer must verify all rough-in dimensions prior to installation and consult local and national codes. Conformity and compliance to local and national codes are the responsibility of the installer.