

FFAS 65 Series



FFAS 65 | Fixed Length

- 12 gauge 316 Stainless Steel grate
- 16 gauge 304 Stainless Steel channel
- Pre-pitched channel with "Fixed" lengths and "Fixed" center vertical (down) outlet location
- Not site sizeable
- Indoor or outdoor use
- Bonded "Flange" installation for flush against the wall.
- Lowest height for curbless installations
- Uses Liquid and Fabric Sheet Membrane waterproofing
- Grate can be removed completely for cleaning
- Flow rate 9 GPM per outlet*

*Flow rate measured at outlet only. Measurement does not account for water in channel or sheeting on shower floor.

Finishes:

- Satin Stainless
- Polished Stainless

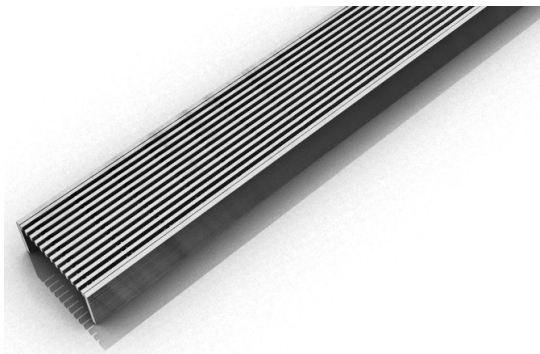

Complete Kits:

FFAS 6524	24" Complete Kit
FFAS 6532	32" Complete Kit
FFAS 6536	36" Complete Kit
FFAS 6542	42" Complete Kit
FFAS 6548	48" Complete Kit
FFAS 6560	60" Complete Kit

Components:

SA 6524	24" Stainless Steel Grate
SA 6532	32" Stainless Steel Grate
SA 6536	36" Stainless Steel Grate
SA 6542	42" Stainless Steel Grate
SA 6548	48" Stainless Steel Grate
SA 6560	60" Stainless Steel Grate
FC 6524	24" Stainless Steel Fixed Channel
FC 6532	32" Stainless Steel Fixed Channel
FC 6536	36" Stainless Steel Fixed Channel
FC 6542	42" Stainless Steel Fixed Channel
FC 6548	48" Stainless Steel Fixed Channel
FC 6560	60" Stainless Steel Fixed Channel

Installation (FF) Fixed Flange

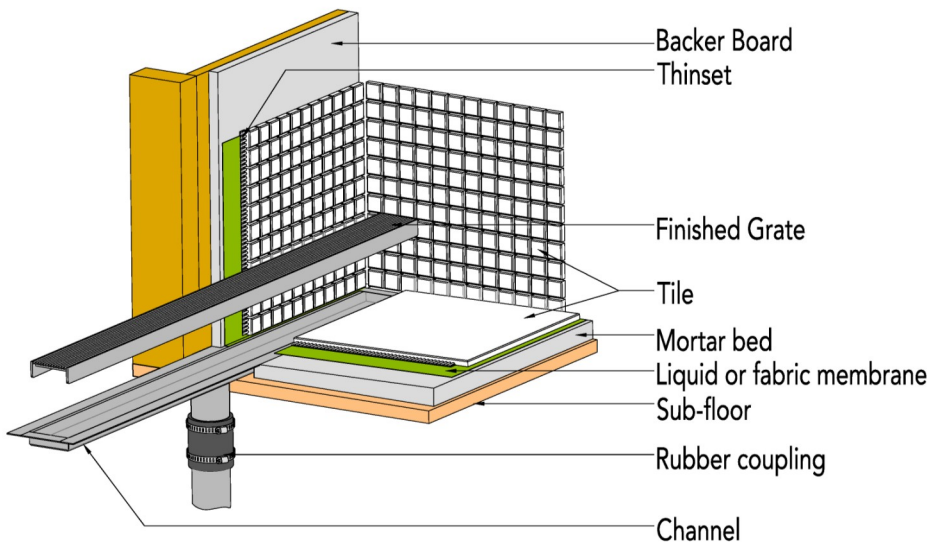

Infinity Drain

18 Secatoag Avenue
 Port Washington, NY 11050
 Phone: 516.767.6786
 Fax: 516.740.3066
 www.InfinityDrain.com

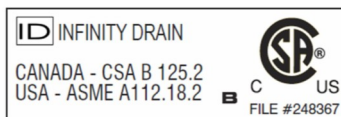

Note: Installer must verify all rough-in dimensions prior to installation and consult local and national codes. Conformity and compliance to local and national codes are the responsibility of the installer.

FFAS 6532 Specifications

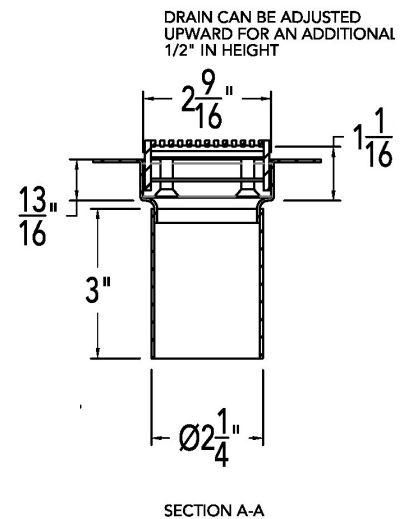
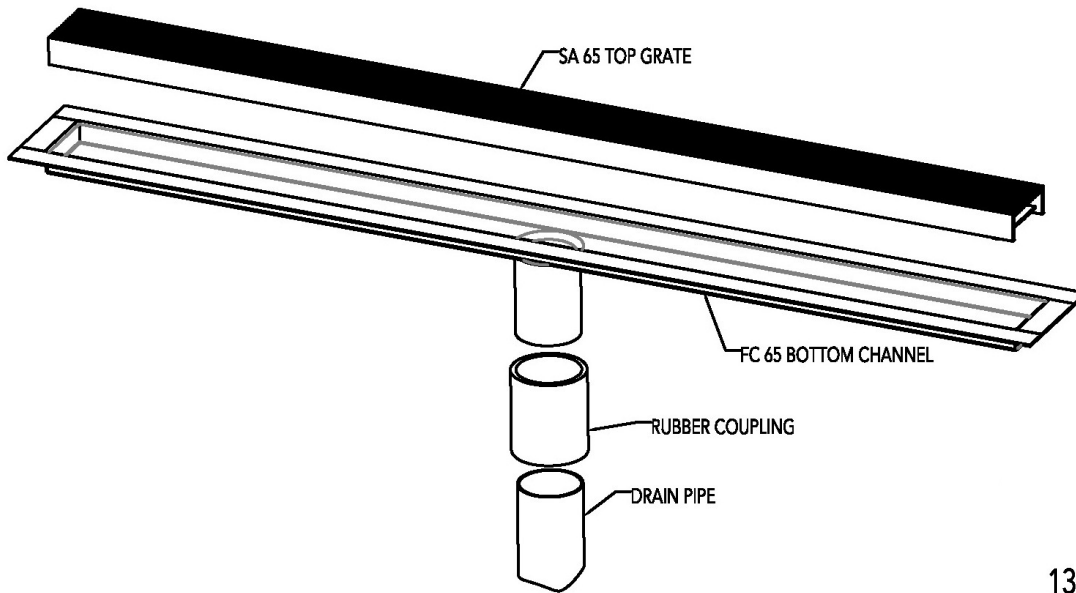
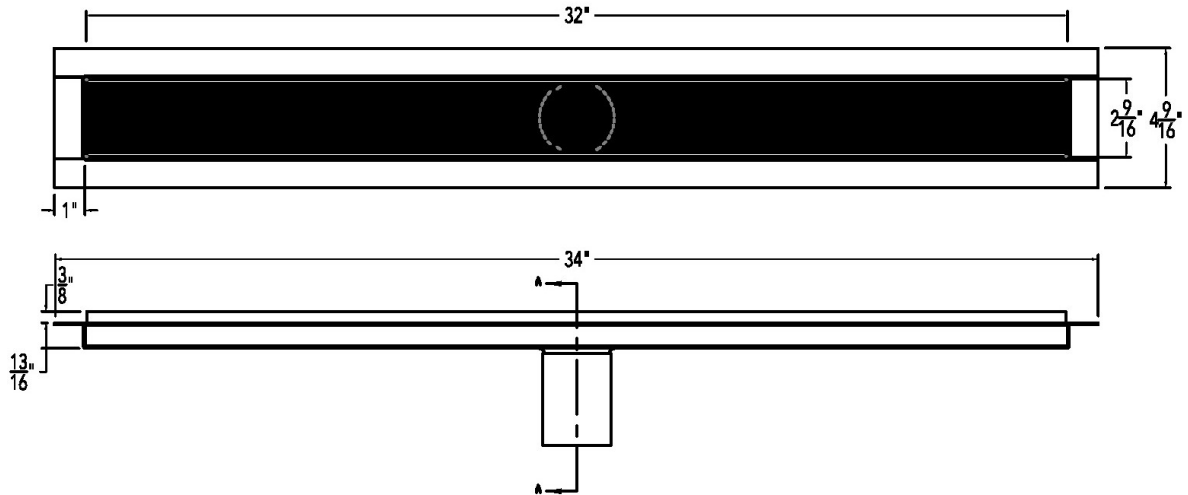

FFAS 6532

32" Complete Kit Includes:

(34 1/8" l x 4 1/2" w x 4 13/16" h)

1 - SA 6532 Grate

1 - FC 6532 Fixed Flange Channel

Infinity Drain

18 Secatoag Avenue
 Port Washington, NY 11050
 Phone: 516.767.6786
 Fax: 516.740.3066
 www.InfinityDrain.com

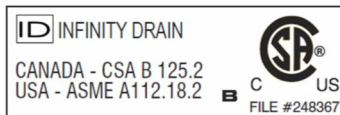

Note: Installer must verify all rough-in dimensions prior to installation and consult local and national codes. Conformity and compliance to local and national codes are the responsibility of the installer.