

FFAS 25 Series

FFAS 25 | Fixed Length

- 12 gauge 316 Stainless Steel grate
- 16 gauge 304 Stainless Steel channel
- Pre-pitched channel with "Fixed" lengths and "Fixed" center vertical (down) outlet location
- Not site sizeable
- Indoor or outdoor use
- Bonded "Flange" installation for flush against the wall.
- Lowest height for curbless installations
- Uses Liquid and Fabric Sheet Membrane waterproofing
- Grate can be removed completely for cleaning
- Flow rate 9 GPM per outlet*

*Flow rate measured at outlet only. Measurement does not account for water in channel or sheeting on shower floor.

Finishes:

- Satin Stainless
- Polished Stainless

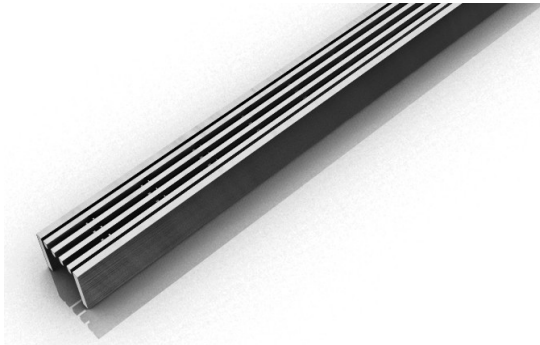

Installation (FF) Fixed Flange

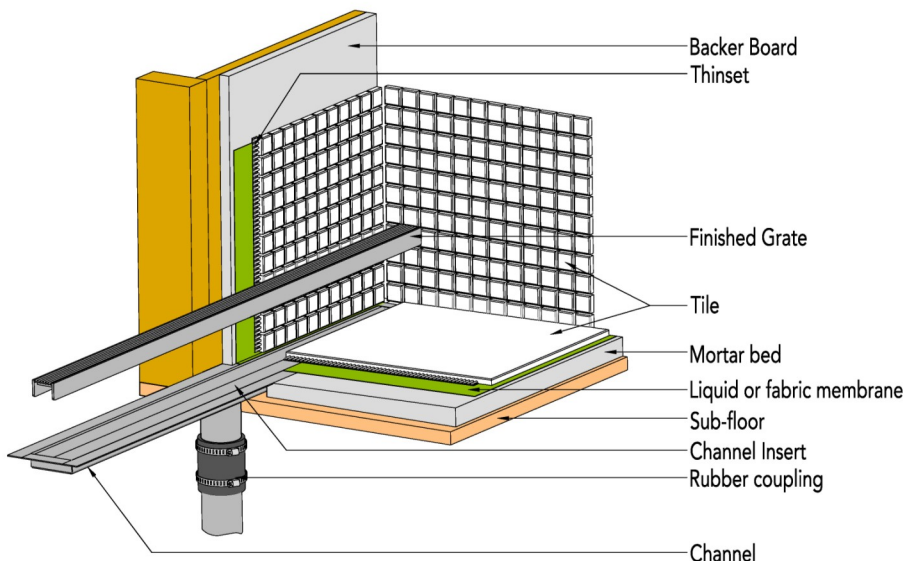

Complete Kits:

FFAS 2532	32" Complete Kit
FFAS 2536	36" Complete Kit
FFAS 2542	42" Complete Kit
FFAS 2548	48" Complete Kit
FFAS 2560	60" Complete Kit

Components:

SA 2532	32" Stainless Steel Grate
SA 2536	36" Stainless Steel Grate
SA 2542	42" Stainless Steel Grate
SA 2548	48" Stainless Steel Grate
SA 2560	60" Stainless Steel Grate
FC 6532	32" Stainless Steel Fixed Channel
FC 6536	36" Stainless Steel Fixed Channel
FC 6542	42" Stainless Steel Fixed Channel
FC 6548	48" Stainless Steel Fixed Channel
FC 6560	60" Stainless Steel Fixed Channel
CI 2532	32" Channel Insert
CI 2536	36" Channel Insert
CI 2542	42" Channel Insert
CI 2548	48" Channel Insert
CI 2560	60" Channel Insert

Infinity Drain

18 Secatoag Avenue
Port Washington, NY 11050
Phone: 516.767.6786
Fax: 516.740.3066
www.InfinityDrain.com

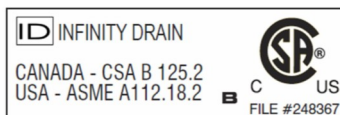

Note: Installer must verify all rough-in dimensions prior to installation and consult local and national codes. Conformity and compliance to local and national codes are the responsibility of the installer.

FFAS 2542 Specifications

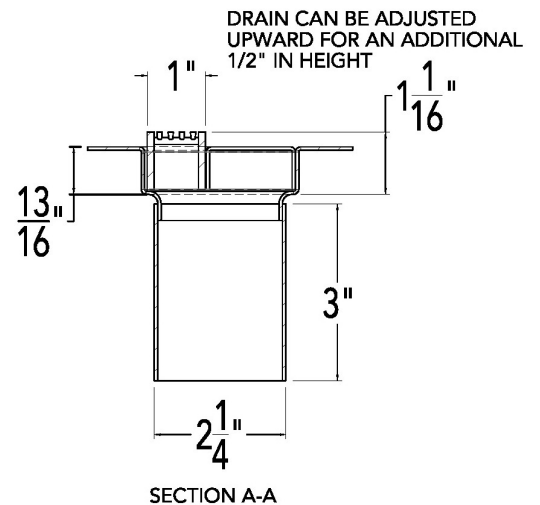
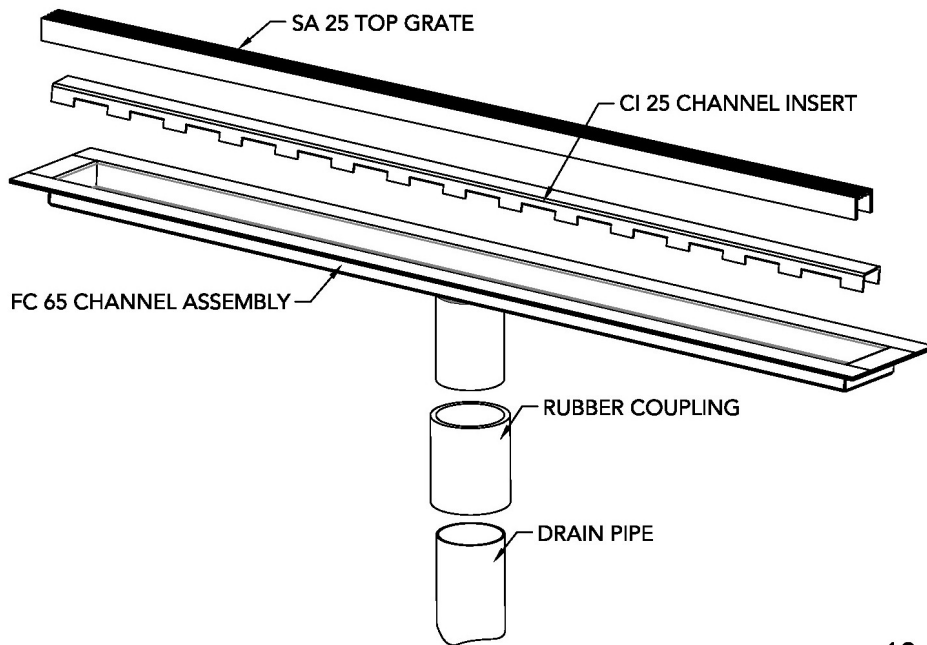
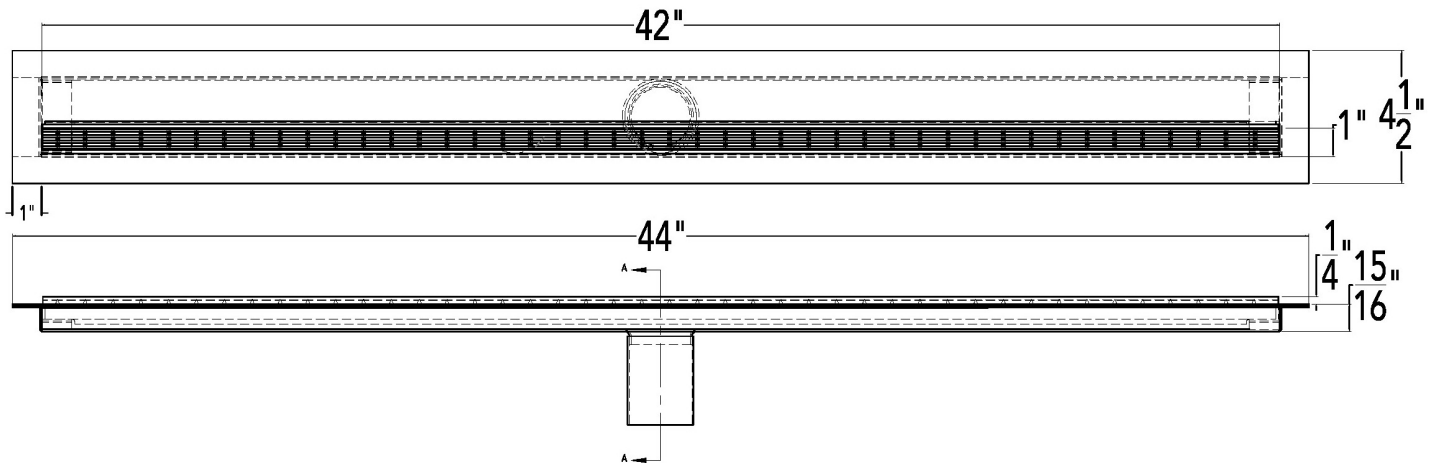

FFAS 2542

42" Complete Kit Includes:

(44 1/8" l x 4 1/2" w x 4 13/16" h)

- 1 - SA 2542 Grate
- 1 - FC 6542 Fixed Flange Channel
- 1 - CI 2542 Channel Insert

Infinity Drain

18 Secatoag Avenue
 Port Washington, NY 11050
 Phone: 516.767.6786
 Fax: 516.740.3066
 www.InfinityDrain.com

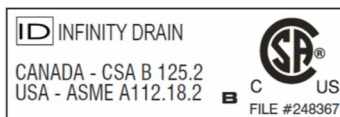

Note: Installer must verify all rough-in dimensions prior to installation and consult local and national codes. Conformity and compliance to local and national codes are the responsibility of the installer.