

MARQUIS 5832

METRO COLLECTION

H | S

AVAILABLE SIZE

- 58.32.21-24

WATER CAPACITY

- 75 Gallons

WEIGHT

- 225 Pounds

BACK SLOPE

- 34°

MATERIAL

- Hydroluxe SS

STANDARD COLORS

- Almond, White, Biscuit

PREMIUM COLORS

- Black, Gray, Carbon, Olive, Espresso, Sky Blue, Blue, Royal Blue, Violet, Pink, Yellow, Lime Green, Red

FINISH

- Matte, Polished, Two-Tone

WARRANTY

- 10 years



OPTIONS (more information available on our website)

- Air System
 - Blower and Control Panel must be remotely located
 - Electrical Requirements 1 15 AMP dedicated GF - 110 Volt
- Hydro Coat
- Island Tub Drain
- Remote Control for Air System
- Tower

INSTALLATION VIDEO AVAILABLE ON WEBSITE:

WWW.HYDROSYSTEM.COM/TECHNICAL-INFORMATION/VIDEOS/

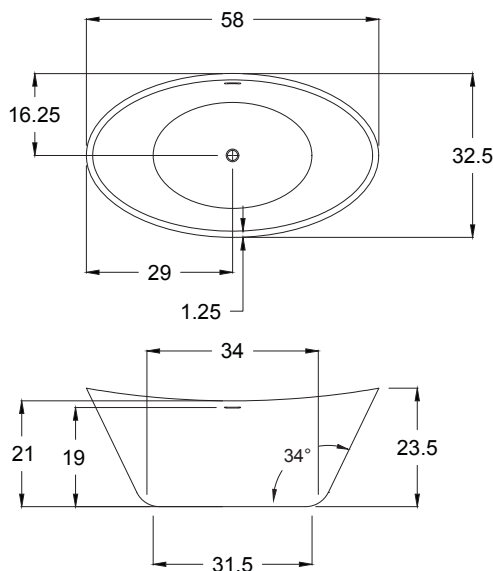

CODES AND COMPLIANCES

Massachusetts code File no: P1-0614-491



HYDRO SYSTEMS
Family Owned And Operated Since 1978

29132 Avenue Paine, Valencia, CA, 91355
661.775.0686 | hydrosystem.com

All specifications and options subject to change without notice please contact a hydro systems representative for more information.