

INSTALLATION INSTRUCTIONS

961,962

GENERAL

1. To ensure the success of the fixture installation, the following instructions and diagram(s) should be read and understood.
2. All electrical connections must be made in accordance with the National Electric code and local codes and ordinances. If you are uncertain of the methods of installing electrical wiring and lighting fixtures secure the services of a qualified licensed electrician.
3. **TOOLS NEEDED:** Blade screwdriver, phillips screwdriver, slip joint pliers or small adjustable wrench, wire cutter/stripper, electrical current tester, stepladder and electrical tape. **NOTE:** The important safeguards and instructions outlined on this sheet are not meant to cover all possible conditions and situations that may occur. It must be understood that common sense, caution and care are factors that cannot be built into any product. Caution and care must be supplied by the person(s) installing, operating and maintaining this lighting fixture.

INSTALLATION PREPARATION

1. **TURN OFF THE ENTIRE ELECTRICAL CIRCUIT TO WHICH THE LIGHTING FIXTURE IS TO BE ATTACHED.** Move the appropriate circuit breaker to the "off" position or completely remove the fuse controlling the circuit.
2. If an existing fixture is being replaced, remove it and note to which of the wires in the outlet box the fixture was attached. **DO NOT SEPARATE ANY OTHER WIRES THAT MAY BE IN THE BOX. DO NOT DAMAGE THE INSULATION OF OLDER WIRING.** In regular circumstances the **BLACK** wire will be the "Hot" lead and the **WHITE** wire will be the "Neutral" or "Common" lead. A **GREEN** or **BARE COPPER** wire is the "Ground". In older buildings it is always good practice to reconfirm the polarity of the wiring.
3. This fixture is designed to be mounted on a standard round or octagon box. The box must be securely mounted to the structure of the building.

FIXTURE INSTALLATION

1. Remove the fixture and parts bag(s) from the carton. Before discarding the carton, double check packing to make certain that all parts are found.
2. Attach the crossbar to the outlet box. (The green screw should face the floor).
3. Fasten the bare copper fixture wire to the green or bare copper wire in the box or bare copper wire in the box to the crossbar with green screw provided. **NEVER FASTEN THE GROUND WIRE TO THE BLACK OR "HOT" WIRE! FAILURE TO FOLLOW THIS INSTRUCTION COULD RESULT IN SERIOUS INJURY OR DEATH!**
4. Fasten the white fixture wire to the white wire in the outlet box. Fasten the wires to together with an approved fastener(wire nut). Starting about 1" below the fastener, tightly wrap connection with the electrical tape so that the tape seals the end of the fastener. Make sure that there is no exposed wire or strands that could cause a dangerous short circuit!
5. Connect the black fixture wires to the black wire in the outlet box. Fasten the joined wires as in step 4.
6. Place the backplate over the outlet box and fasten it by screws.
7. Install the lamp(s) The fixture is rated for 60 watt type C lamp(s). **DO NOT EXCEED RECOMMENDED WATTAGE!**
8. Carefully open the clips in the shade(s). Place the shade(s) on the lamp.
9. Restore power to circuit at breaker or fuse box.

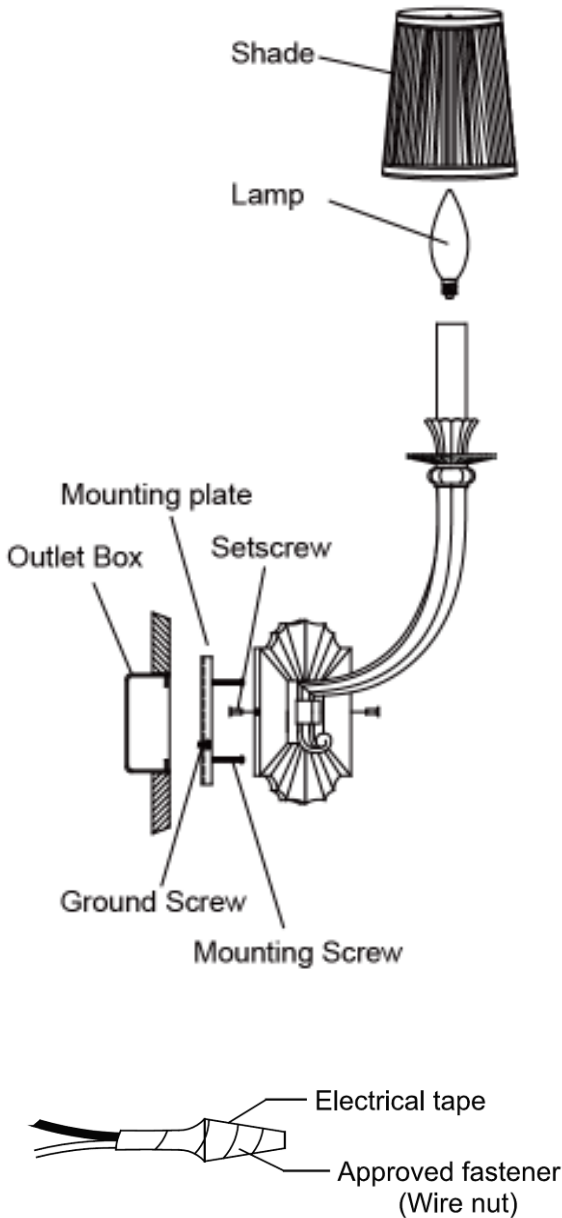

Hudson Valley Lighting, Inc.
P.O. Box 7459
106 Pierces Road
Newburgh, NY 12550
(800) 814-3993
www.hudsonvalleylighting.com