

Classic Picture Lights

TRADITIONAL

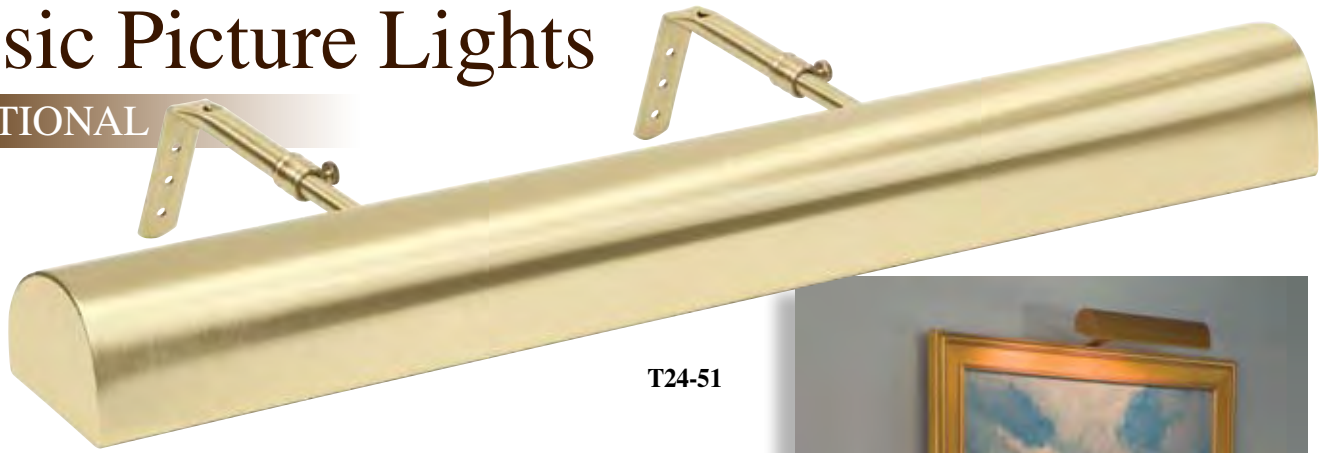

T24-51



T8-1

Features

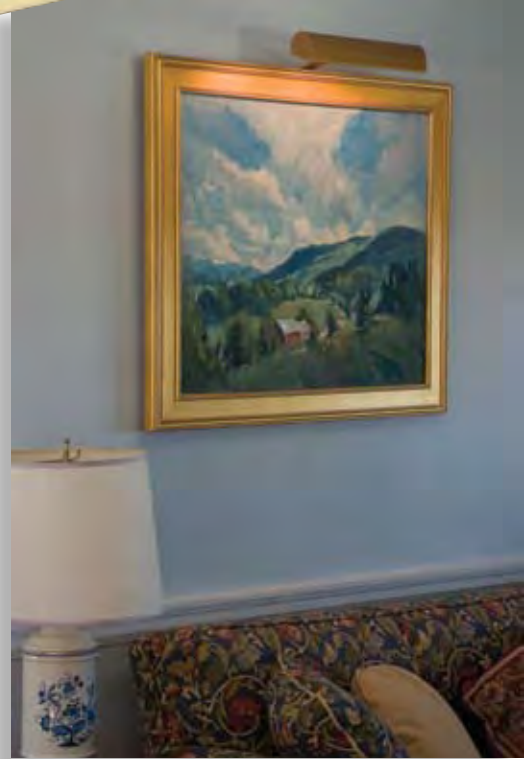
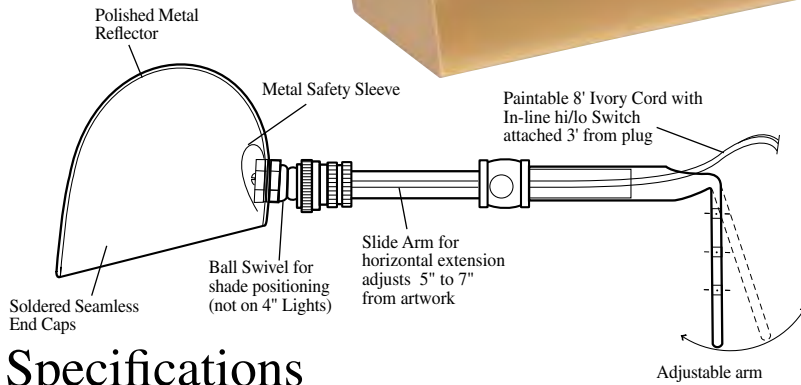

T14-1

Specifications

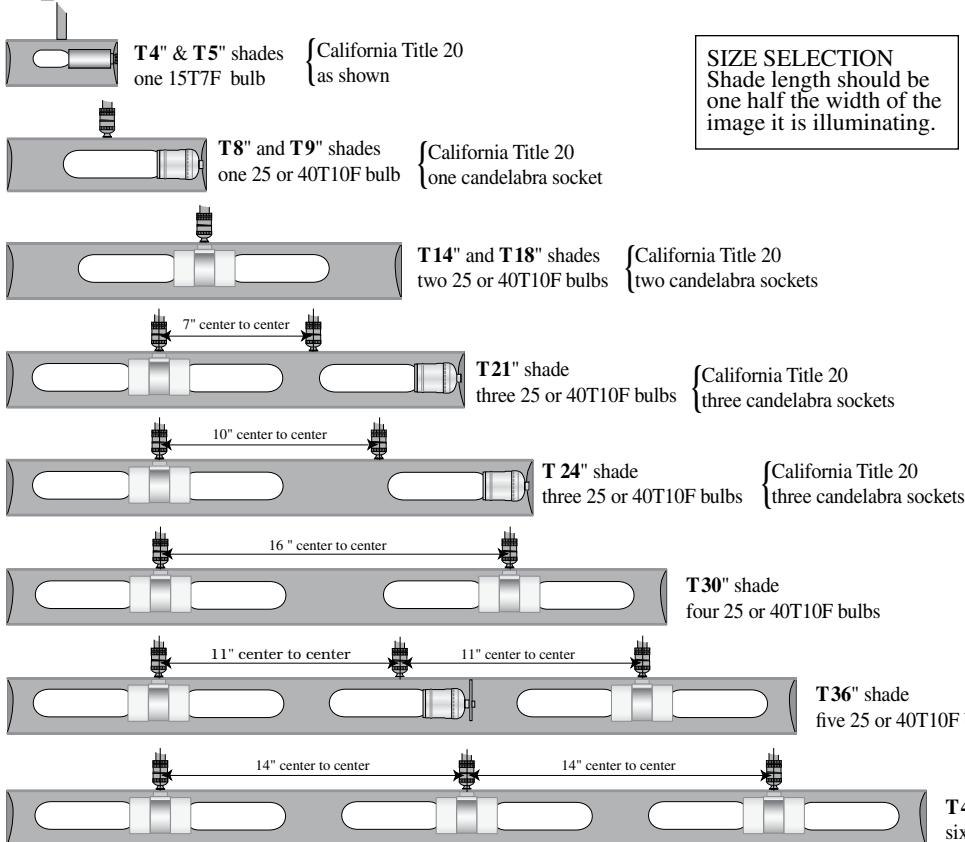

SIZE SELECTION
Shade length should be one half the width of the image it is illuminating.

Finishes

- Gold #1
- Gold Wrinkle #2
- Bronze #5
- Pewter #31
- Satin Brass #51
- Statuary Bronze #56
- Polished Brass #61
- Antique Brass #71
- Weathered Brass #76
- Mahogany Bronze #81

Custom orders available on request.

NOTE:
Traditional Series Picture Lights with more than one arm, have a UL-LISTED, pre-wired, aluminum splice-box (2" x 2" x 3/8") that hangs behind the artwork.

Classic Picture Lights

CONTEMPORARY

Craftsmanship and reliability are hallmarks of House of Troy products.



C9-52



C9-52

Features

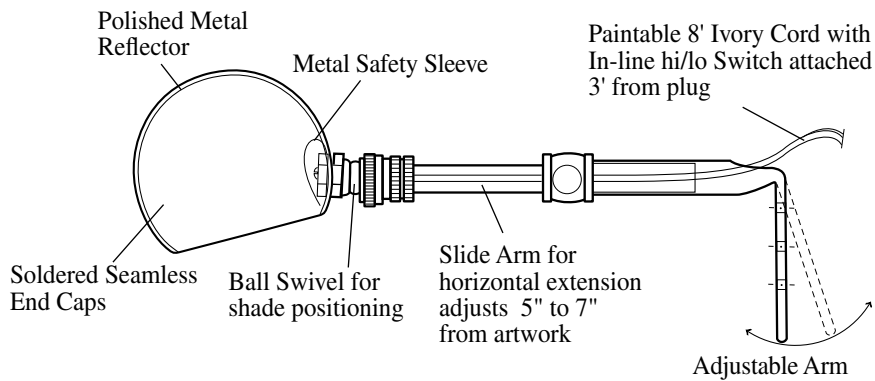

Specifications

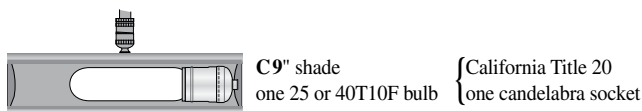
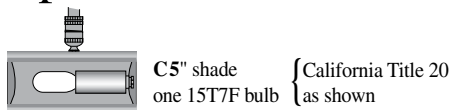

Finishes

- Gold #1
- Satin Brass #51
- Satin Nickel #52
- Polished Brass #61
- Chrome #62

SIZE SELECTION
Shade length should be one half the width of the image it is illuminating.

Traditional LED Picture Lights



TLED14-1



TLED14-71

Benefits of LED

- No UV or IR
- Energy Efficient
- Long Life: 30,000 Hours
- Warm White Output

Features

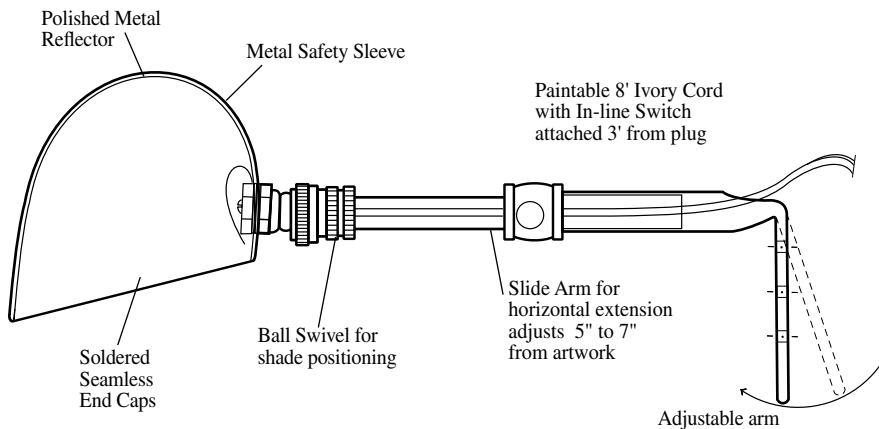

Finishes

- Gold #1
- Gold Wrinkle #2
- Bronze #5
- Pewter #31
- Satin Brass #51
- Statuary Bronze #56
- Polished Brass #61
- Antique Brass #71
- Weathered Brass #76
- Mahogany Bronze #81

LED SPECIFICATIONS

Shade Sizes	CRI	CCT	Watts	Lumens	Lifetime	Equivalent Incandescent
10"	93	3400K	1.6	38.4	30,000 hrs	(1) 25 Watt
14"	93	3400K	2.4	57.6	30,000 hrs	(2) 25 Watt
24"	93	3400K	4	96	30,000 hrs	(3) 25 Watt
36"	93	3400K	6.4	153.6	30,000 hrs	(5) 25 Watt

SIZE SELECTION
Shade length should be one half the width of the image it is illuminating.

Richardson Reflector

PICTURE LIGHTS

Finish

Gold #1

Features

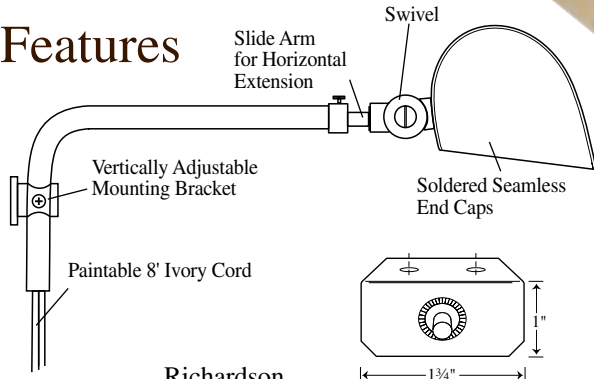

Richardson FRAME SWITCH (FRSW)

Optional Type "D" Switch, attaches to back of frame (switch sold separately).

SIZE SELECTION
Shade length should be one half the width of the image it is illuminating.



RR8-1

Specifications

RR5" shade
one 15T7F bulb
arm extends 5" to 7"

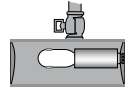

RR8" shade
one 25 or 40T10F bulb
arm extends 5" to 7"

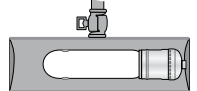

RR14" shade
two 25 or 40T10F bulbs
arm extends 7" to 9"

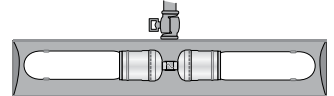

RR24" shade
three 25 or 40T10F bulbs
arm extends 8" to 10"

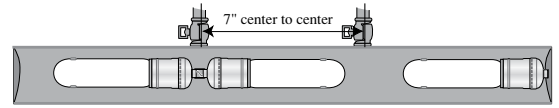

RR30" shade
four 25 or 40T10F bulbs
arm extends 8" to 10"

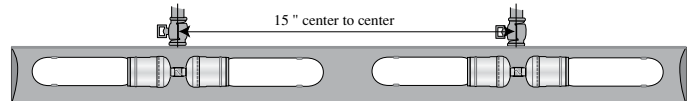

Hyde Park Picture Lights

SIZE SELECTION
Shade length should be one half the width of the image it is illuminating.

HP16-91



Specifications

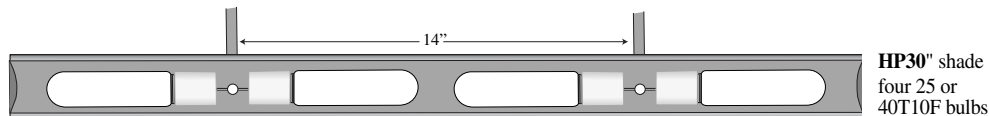
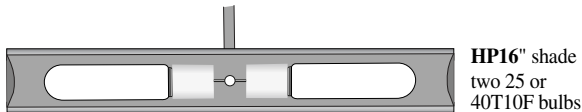
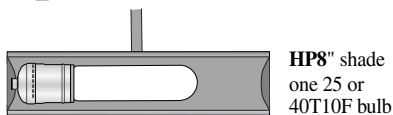

Features

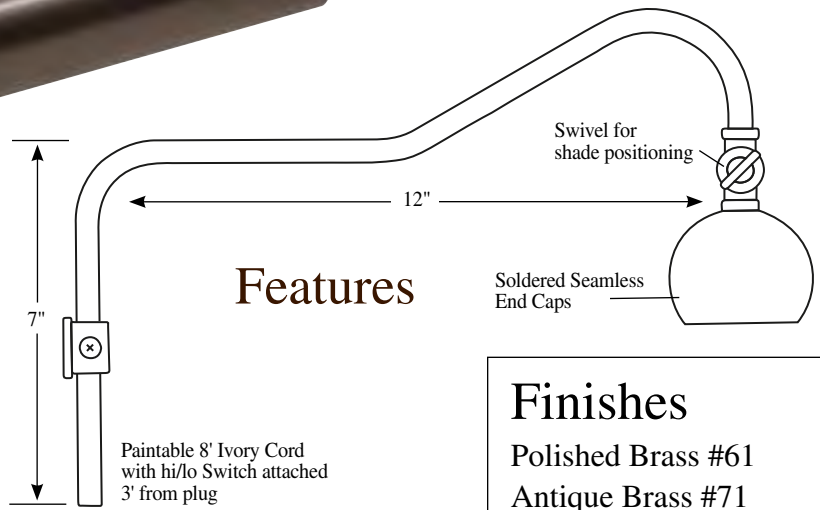

Finishes

- Polished Brass #61
- Antique Brass #71
- Weathered Brass #76
- Oil Rubbed Bronze #91

NOTE: Custom orders available on request.

Slim-Line™ Picture Lights

SL



SL16-61

Finishes

- Black #7
- White #9
- Satin Brass #51
- Satin Nickel #52
- Polished Brass #61
- Chrome #62
- Antique Brass #71
- Weathered Brass #76
- Oil Rubbed Bronze #91

NOTE: Custom orders available on request.

Features

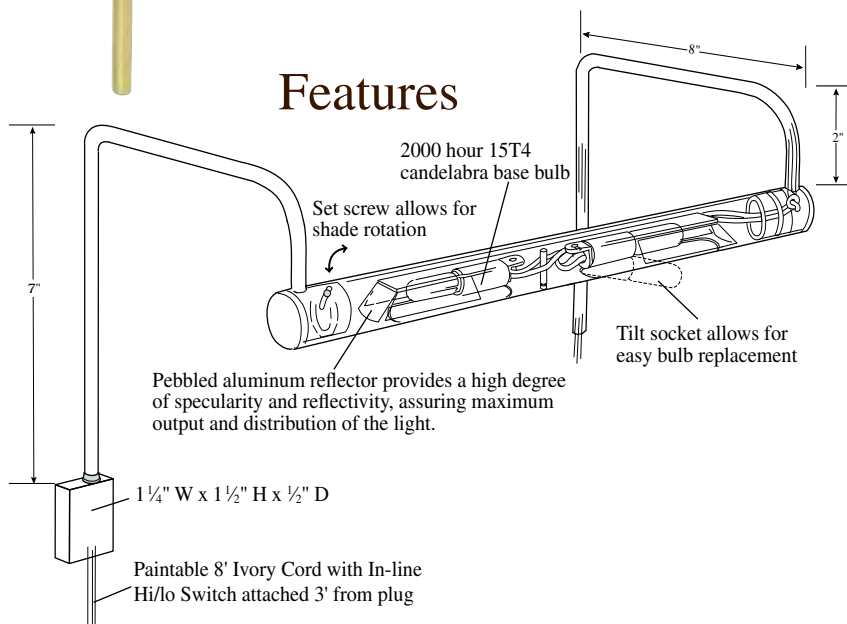

SL16-61

The Slim-line™ series is an excellent way of illuminating without detracting from the art work. Its sleek profile emphasizes the art work and does not visually intrude.

Specifications

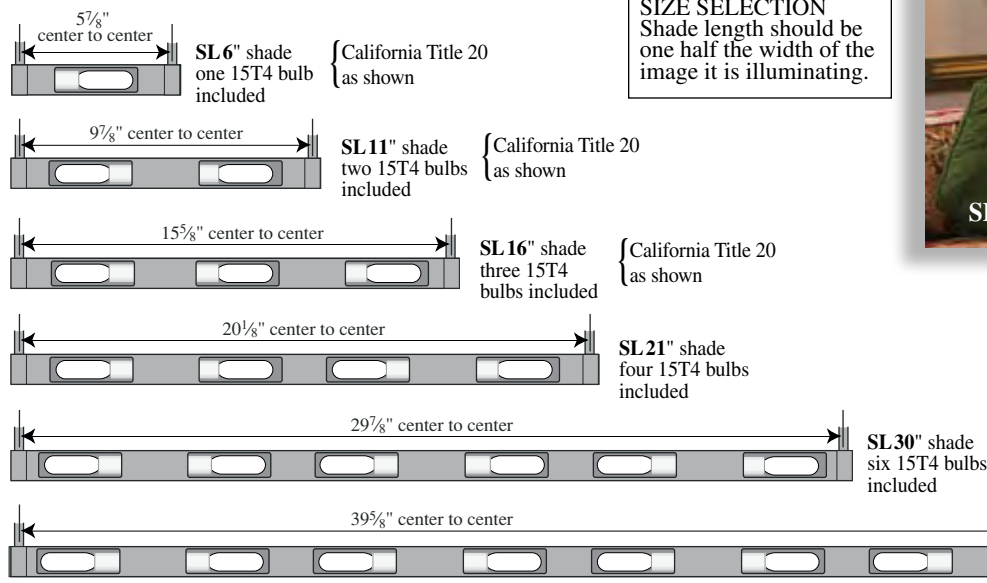

SIZE SELECTION
Shade length should be one half the width of the image it is illuminating.

Non stocked lamps available with three arms in 64" and 84" lengths.

Slim-Line™ Picture Lights

XL

New!

Finishes

- Satin Brass #51
- Satin Nickel #52
- Polished Brass #61
- Chrome #62
- Antique Brass #71
- Oil Rubbed Bronze #91



XL14-71



XL36-52

Specifications

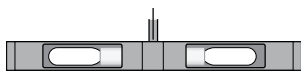

XL14" shade
Two 15T4 bulbs

{ California Title 20
as shown

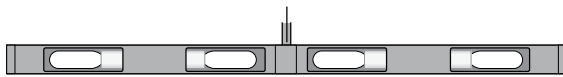

XL24" shade
Four 15T4 bulbs

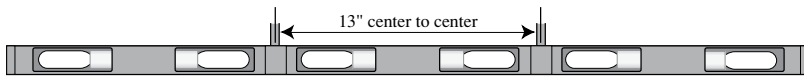

XL36" shade
Six 15T4 bulbs

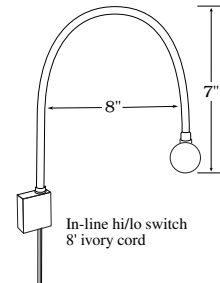

In-line hi/lo switch
8" ivory cord

Horizon LED Picture Lights



New!

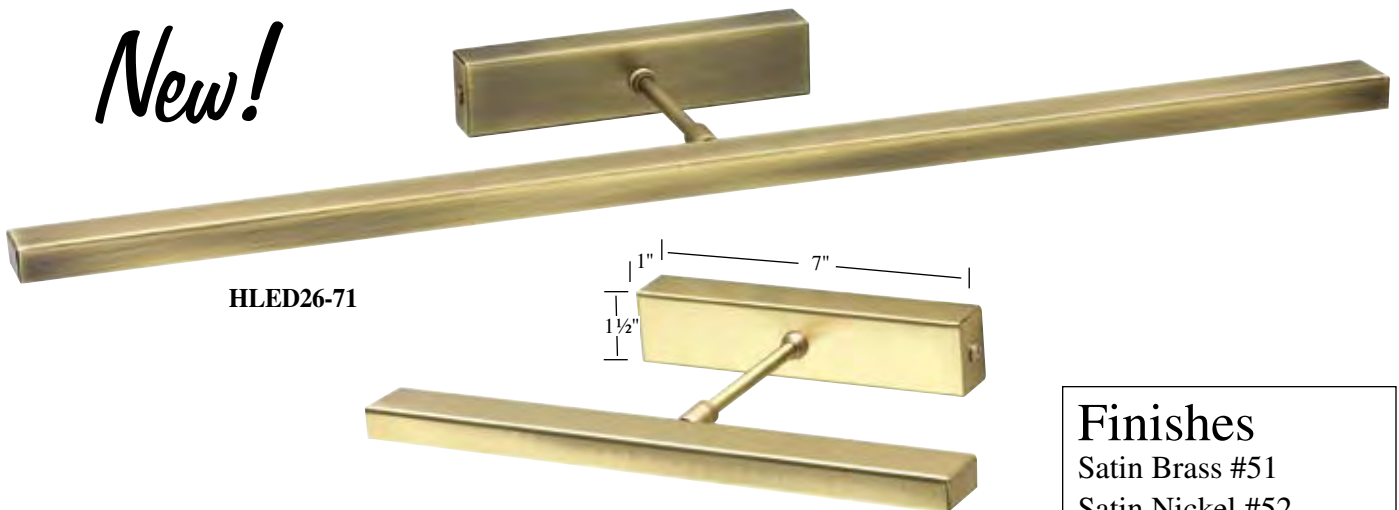

HLED26-71

HLED12-51

LED SPECIFICATIONS

Shade Size	CRI	CCT	Watts	Lumens	Lifetime	Equivalent Incandescent
26"	85	3000K	8	440	30,000 hrs	(4) 25 Watt
12"	85	3000K	4	220	30,000 hrs	(2) 25 Watt

Finishes

- Satin Brass #51
- Satin Nickel #52
- Chrome #62
- Antique Brass #71
- Oil Rubbed Bronze #91

Slim-Line™ LED

PICTURE LIGHTS



New!



SLED29-51

Benefits of LED

- No UV or IR
- Energy Efficient
- Long Life: 30,000 Hours
- Warm White Output

Finishes

- Satin Brass #51
- Satin Nickel #52
- Polished Brass #61
- Antique Brass #71
- Oil Rubbed Bronze #91



LED SPECIFICATIONS

Shade Size	CRI	CCT	Watts	Lumens	Lifetime	Equivalent Incandescent
15"	85	3000K	4	220	50,000 hrs	(2) 25 Watt
29"	85	3000K	8	440	50,000 hrs	(4) 25 Watt

SIZE SELECTION
Shade length should be one half the width of the image it is illuminating.

Ultraslim-LED

PICTURE LIGHTS



ADA COMPLIANT



USLED20-71

Finishes

- Satin Nickel #52
- Polished Brass #61
- Chrome #62
- Antique Brass #71

SIZE SELECTION
Shade length should be one half the width of the image it is illuminating.

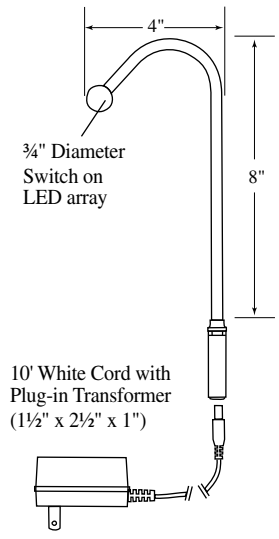

LED SPECIFICATIONS

Shade Size	CRI	CCT	Watts	Lumens	Lifetime	Equivalent Incandescent
20"	75	3000K	2.2	80	30,000 hrs	(4) 15 Watt

Advent™ Standard PICTURE LIGHTS



A7-71



A14-61

This light combines simple construction with moderate pricing. It has many quality features and is a reliable lighting alternative.

Features

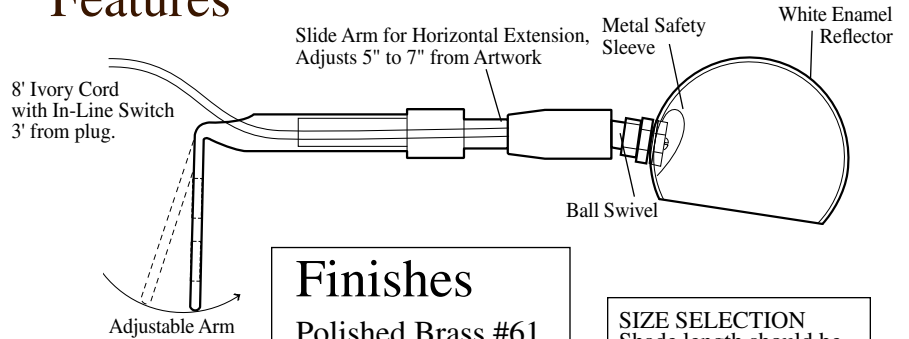

Specifications

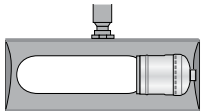

A7" shade
one 25T10F bulb

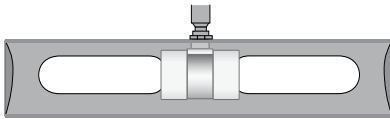

A14" shade
two 25T10F bulbs

Finishes

- Polished Brass #61
- Antique Brass #71

SIZE SELECTION
Shade length should be
one half the width of the
image it is illuminating.



AG-7

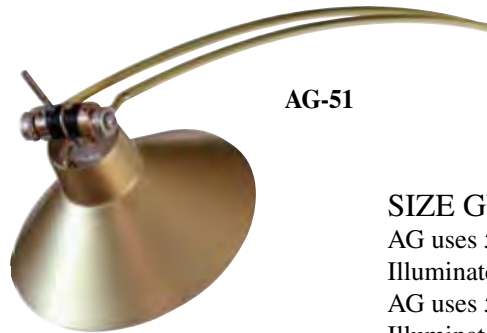

AG-51

Advent™ Gemini PICTURE LIGHTS

SIZE GUIDE

AG uses 50W Standard Flood (included).
Illuminates up to 3' x 5' area
AG uses 50W Narrow Flood (optional).
Illuminates up to 3' x 3' area

Features

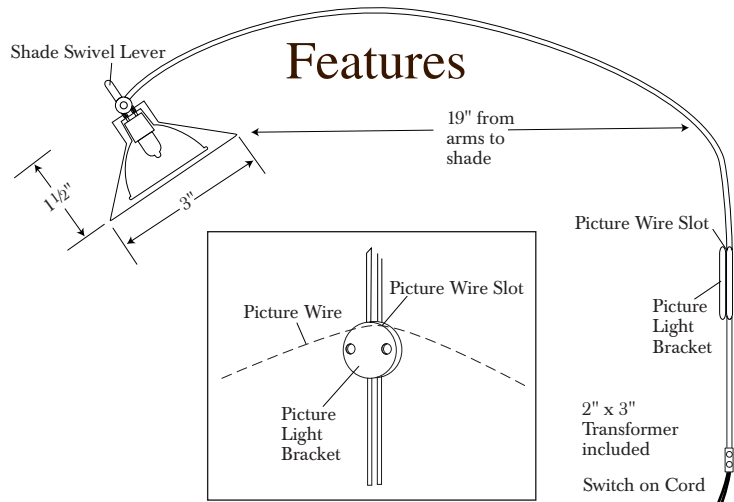

Finishes

- Black #7
- Satin Brass #51
- Satin Nickel #52
- Antique Brass #71

Advent™ Profile Picture Lights

INCANDESCENT



Finishes

- Black #7
- Satin Nickel #52
- Polished Brass #61
- Antique Brass #71

APR16-61

SIZE SELECTION
Shade length should be one half the width of the image it is illuminating.

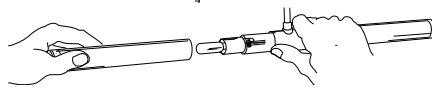
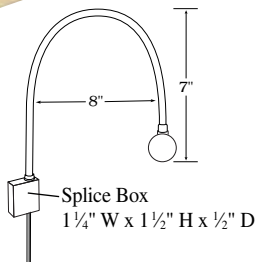

Shade removes for easy bulb replacement and rotates for light adjustment on APR16



APR16-7

The black finish of the Profile light matches and complements the frame and art work.

Specifications

APR16" shade
two 15T4 bulbs
included

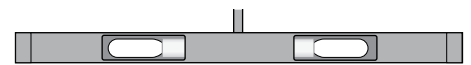

California Title 20 as shown

Advent™ Profile Picture Lights

HALOGEN

The Halogen Profile light is UV filtered and gives off a more natural and whiter light. Transformer included.

Finishes

- Black #7
- Satin Nickel #52
- Polished Brass #61
- Antique Brass #71

Specifications

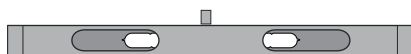

APH16" shade
two 20 Watt Halogen bulbs
included 73% UV filtered

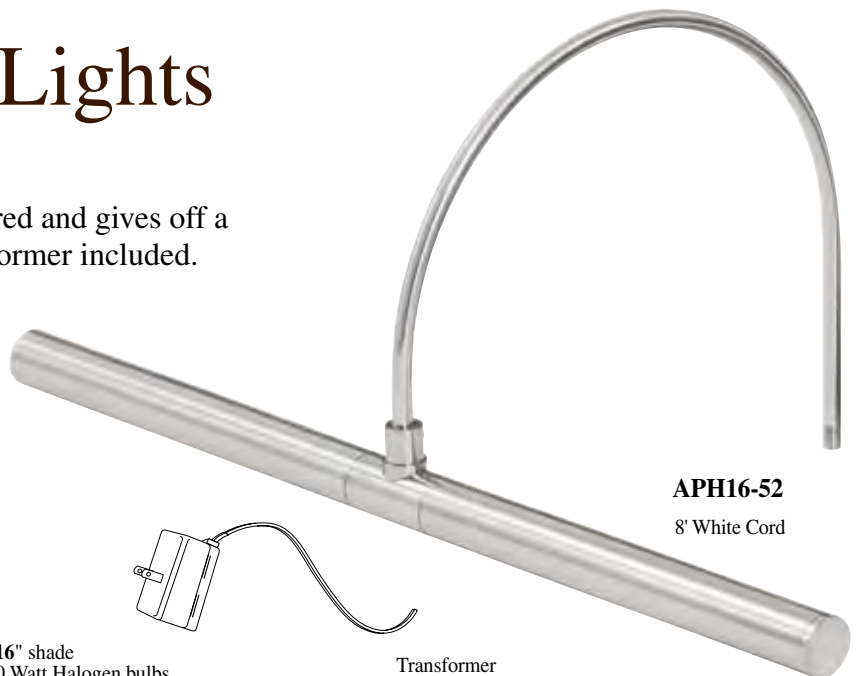

APH16-52
8' White Cord

Transformer
1 3/4" W x 2 3/4" H x 1 1/8" D

Direct Wire Picture Lights

Our Direct Wire™ Picture Lights are ideal in a commercial setting where lighting needs to be permanently affixed to the wall. Direct Wire™ is also a solution for those who object to seeing the cord.

TRADITIONAL



DT24-61

Finishes

- Polished Brass #61
- Mahogany Bronze #81

Specifications

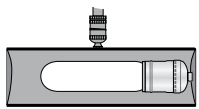

DT8" shade
one 25 or 40T10F bulb
Backplate: 4½" x 4½" x ⅜"

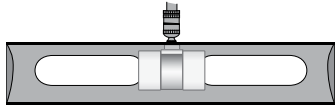

DT14" shade
two 25 or 40T10F bulbs
Backplate: 4½" x 4½" x ⅜"

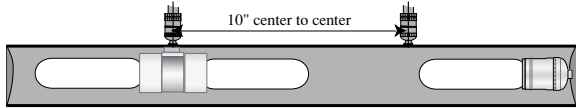

DT24" shade
three 25 or 40T10F bulbs
Backplate: 4" x 15" x ⅜"

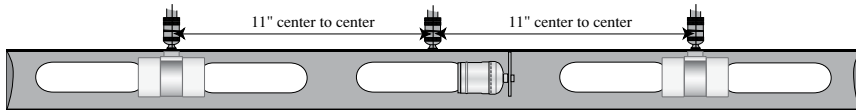

DT36" shade
five 25 or 40T10F bulbs
Backplate: 4" x 26" x ⅜"

Features

Direct Wire™ Picture Lights are designed to mount over standard 2" x 4", 4" x 4" or octagonal boxes.

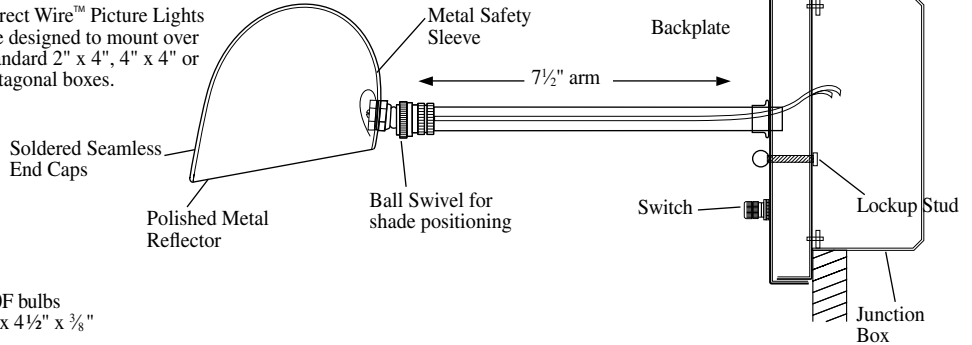

SIZE SELECTION
Shade length should be one half the width of the image it is illuminating.

CONTEMPORARY

Finishes

- Polished Brass #61
- Chrome #62

Specifications

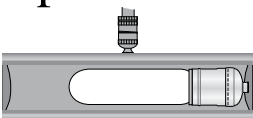

DC9" shade
one 25 or 40T10F bulbs
Backplate: 4½" x 4½" x ⅜"

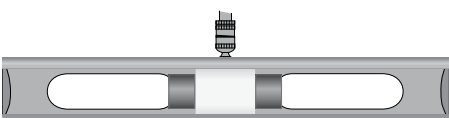

DC16" shade
two 25 or 40T10F bulbs
Backplate: 4½" x 4½" x ⅜"

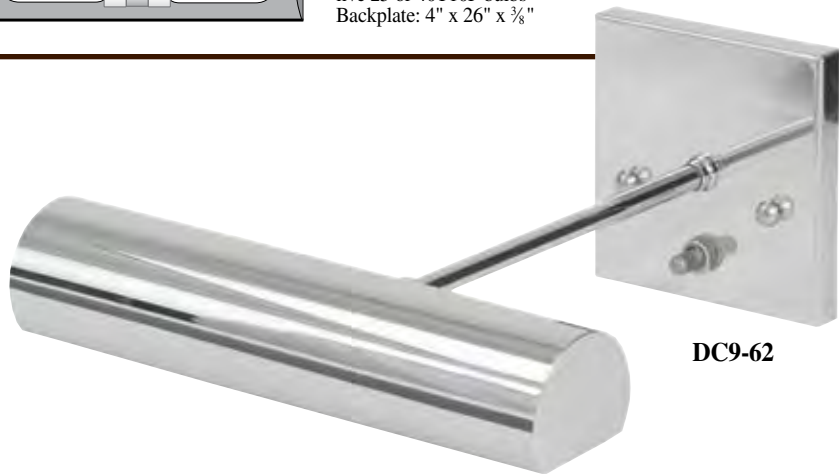

DC9-62

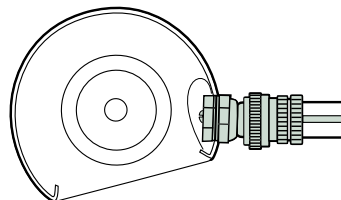

Contemporary Shade Profile

NOTE: Custom orders available on request.

Direct Wire Slim-line™

PICTURE LIGHTS

SL

Finishes

- Satin Brass #51
- Satin Nickel #52
- Antique Brass #71
- Oil Rubbed Bronze #91

NOTE: Custom orders available on request.



DSL24-52
BACKPLATE:
2 3/4" H x 4 1/2" W x 1/2" D



DSL36-51
BACKPLATE:
2 3/4" H x 17 1/2" W x 1/2" D



Specifications

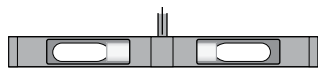

DSL14" shade
two 15T4 bulbs
included

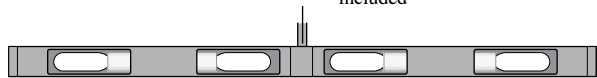

DSL24" shade
four 15T4 bulbs
included

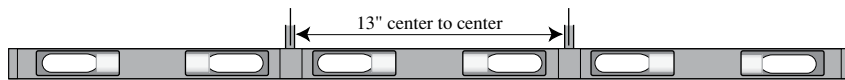

DSL36" shade
six 15T4 bulbs
included

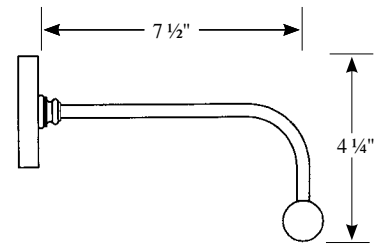

Direct Wire Slim-line™

PICTURE LIGHTS

XL

Finishes

- Satin Brass #51
- Satin Nickel #52
- Polished Brass #61
- Chrome #62
- Antique Brass #71
- Oil Rubbed Bronze #91

Specifications

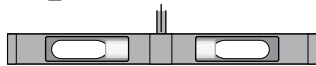

DXL14" shade
two 15T4 bulbs
included

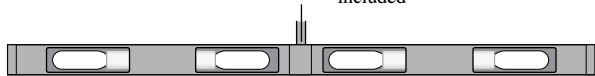

DXL24" shade
four 15T4 bulbs
included

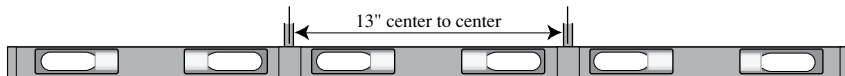

DXL36" shade
six 15T4 bulbs
included



DXL24-91
BACKPLATE: 5" diameter

NOTE: Custom orders available on request.

SIZE SELECTION
Shade length should be one half the width of the image it is illuminating.



DXL36-62
BACKPLATE:
2 3/4" x 17 1/2"

Direct Wire™ LED Picture Lights



TRADITIONAL

Finishes
 Polished Brass #61
 Mahogany Bronze #81

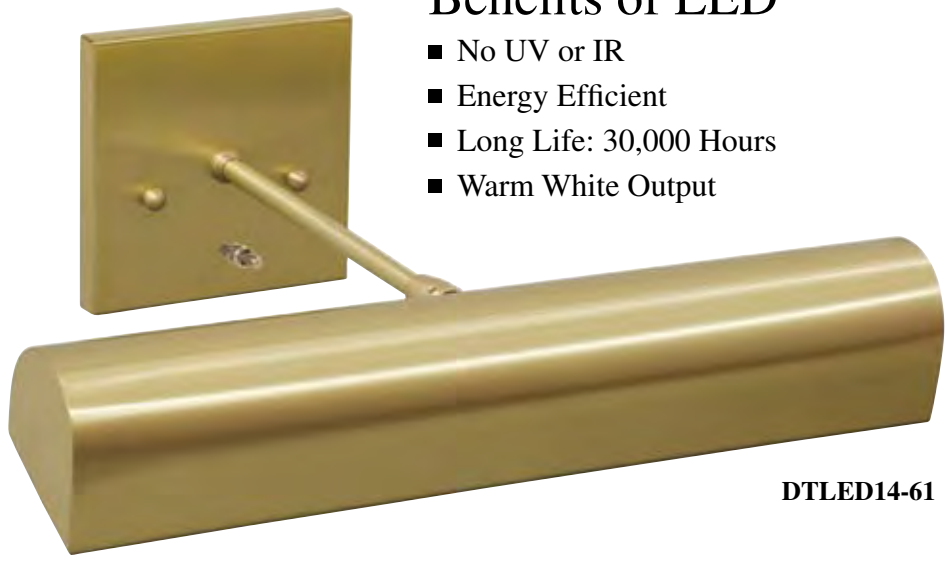

Benefits of LED

- No UV or IR
- Energy Efficient
- Long Life: 30,000 Hours
- Warm White Output

DTLED14-61

LED SPECIFICATIONS

Shade Sizes	CRI	CCT	Watts	Lumens	Lifetime	Equivalent Incandescent	Backplate Dimensions
10"	93	3400K	1.6	38.4	30,000 hrs	(1) 25 Watt	4½" x 4½" x ½"
14"	93	3400K	2.4	57.6	30,000 hrs	(2) 25 Watt	4½" x 4½" x ½"
24"	93	3400K	4	96	30,000 hrs	(3) 25 Watt	4" x 15" x ½"
36"	93	3400K	6.4	153.6	30,000 hrs	(5) 25 Watt	4" x 26" x ½"

NOTE: Custom orders available on request.

SLIM-LINE™

Finishes
 Satin Brass #51
 Satin Nickel #52
 Antique Brass #71
 Oil Rubbed Bronze #91

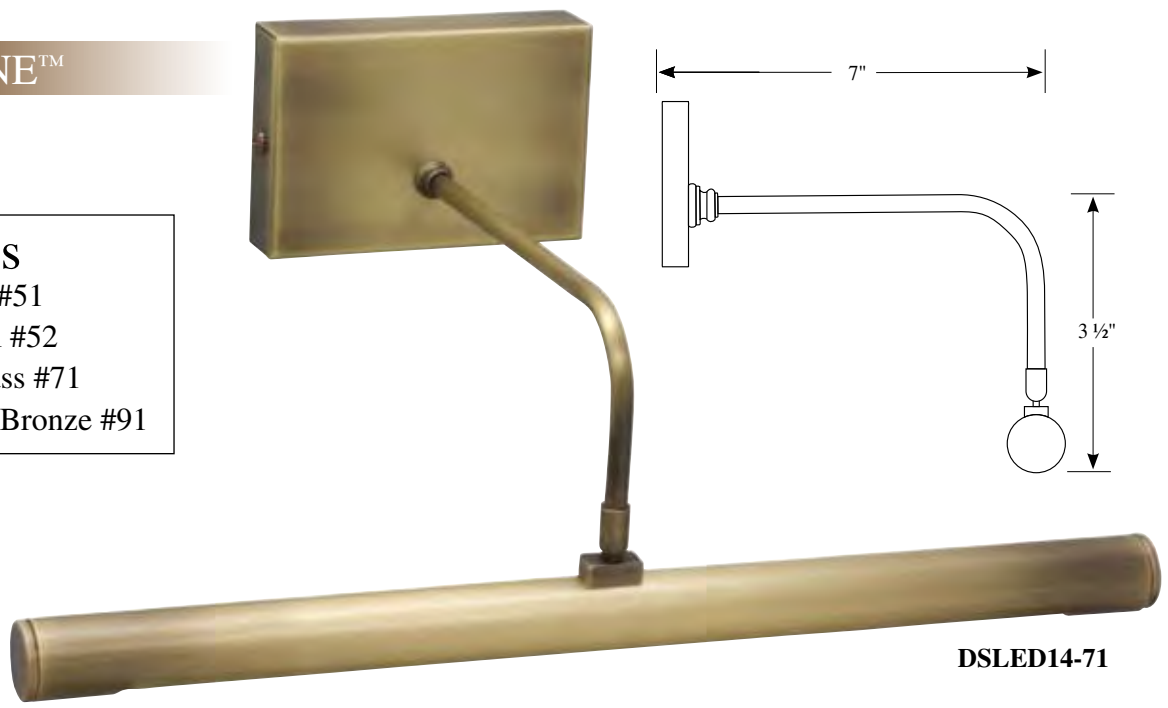

DSLED14-71

LED SPECIFICATIONS

Shade Size	CRI	CCT	Watts	Lumens	Lifetime	Equivalent Incandescent	Backplate Dimensions
14"	85	3000K	4	220	50,000 hrs	(2) 25 Watt	3¼"H x 4½"W x 1"D
24"	85	3000K	8	440	50,000 hrs	(4) 25 Watt	3¼"H x 4½"W x 1"D

SIZE SELECTION
 Shade length should be one half the width of the image it is illuminating.

Battery Operated LED Picture Lights



BTLED24-71

BTLED14-51

Uses 4 C Batteries (not included).
Switch on backplate.

SIZE SELECTION
Shade length should be
one half the width of the
image it is illuminating.

Finishes

- Gold #1
- Satin Brass #51
- Polished Brass #61
- Antique Brass #71
- Mahogany Bronze #81

New!

LED SPECIFICATIONS

BTLED/BSLED							
Shade Size	CRI	CCT	Watts	Lumens	Lifetime	Equivalent Incandescent	Backplate Dimensions
14"	75	3000K	1.6	44	30,000 hrs	(2) 25 Watt	3¼"H x 4½"W x 1"D
24"	75	3000K	3.2	88	30,000 hrs	(2) 25 Watt	3¼"H x 4½"W x 1"D

SLIM-LINE™

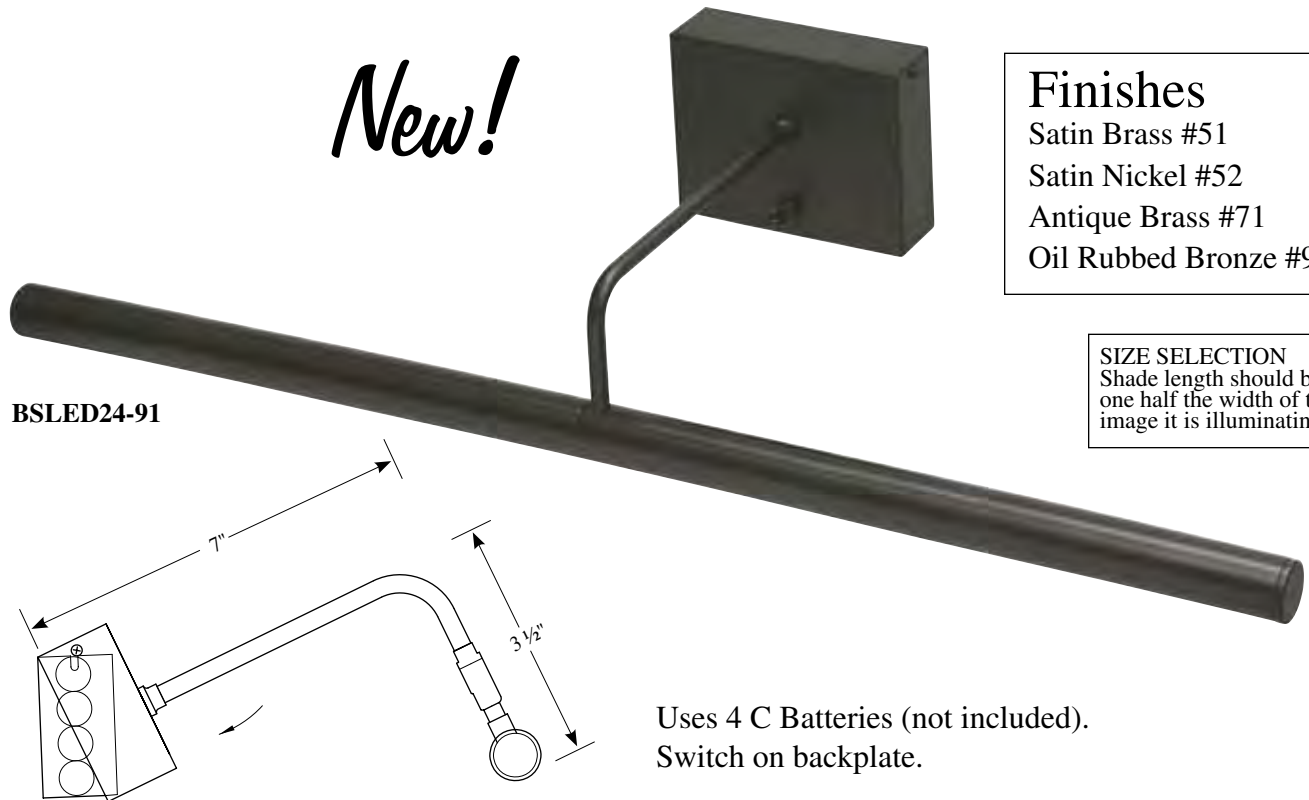

New!

Finishes

- Satin Brass #51
- Satin Nickel #52
- Antique Brass #71
- Oil Rubbed Bronze #91

SIZE SELECTION
Shade length should be
one half the width of the
image it is illuminating.

BSLED24-91

Uses 4 C Batteries (not included).
Switch on backplate.

Battery Operated Picture Lights



ALED15-1



ALED15-7

Built in →
picture
hanger on
mounting
clip.

LED Multi-task Light

- Switch on back of shade
- 24 Hours on 4 AA batteries (not included)
- 30,000 hours LED life

LED SPECIFICATIONS

Shade Size	CRI	CCT	Watts	Lumens	Lifetime	Equivalent Incandescent
15"	75	8000K	1.9	59.5	30,000 hrs	(1) 15 Watt

Clip: 2³/₈"W x 3"H,
Expands to fit surfaces
up to 3/4" wide.

Finishes

Gold #1
Black #7

Advent[™] 14" FLUORESCENT

UV Tested—Safe For
Artwork, Maximum Light
Output Up To 45 Hours with
4 D batteries (not included).

Finishes

Satin Nickel #52
Brass #61
Antique Brass #71



ABF14-71

Practical only where
power is not available.

Advent[™] 7" INCANDESCENT →

Illuminates 6–8 hours with only
4 AA batteries (not included).

Finishes

Polished Brass #61
Antique Brass #71



AB7-61

TRADITIONAL RECHARGABLE

Rechargeable Battery
Operates 6–8 hours per charge.

Recharger included.

Shade Length and
Bulb Information

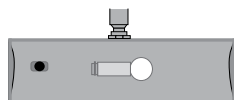

RT8"
One #40, 8 hour and
one #46, 6 hour bulb included

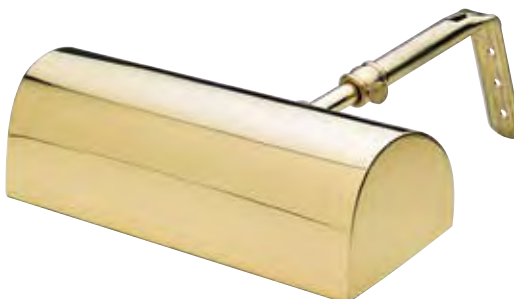

RT8-61

Practical only where
power is not available.

Finishes

Gold #1
Statuary Bronze #56
Polished Brass #61

Mantel Light



MA14-AB



MA14-B

HEIGHT: 4½" BASE: 15" wide, 3" deep
10' Brown Cord Exits Back of Shade.
In-Line Switch 15" from Fixture.

Finishes

Polished Brass (B)
Antique Brass (AB)
Mahogany Bronze (MB)

Shade Length and Bulb Location

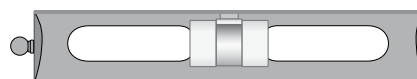

MA14"
two 25 or 40T10F bulbs

Advent[™] Cabinet Light



AC7-61

Finishes

Polished Brass #61
Antique Brass #71



← L10-61

FINISH: Polished Brass
HEIGHT: 7"
1¾" Between Arms
SWITCH: On Shade
SHADE: 10"
CORD: 10' Brown with
Snap-On Plug
Included

Lectern Light

Designed to be permanently
installed on surfaces up to 2" thick.

Shade Length and Bulb Location

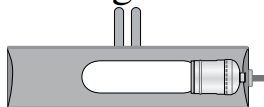

L10
one 40T10F or 60T10 bulb

Bed Light



→ BL10-AB

FINISH: Antique Brass
HEIGHT: Gooseneck Adjusts
from 0" to 8 ½"
BASE: Adjustable clip
Up to 2 ½" Wide
BULB: One 40T10
SWITCH: On Shade
SHADE: 10"
CORD: 10' Brown

Advent™ Portable Spot Lights



Mini-cans

SP-510-7
HEIGHT: 6 ½"

SP-512-7
HEIGHT: 6 ½"

Satin Nickel Finish

SWITCH: On 10' black cord,
18" from shade



Mini-cans

SP-510-52
HEIGHT: 6 ½"

SP-512-52
HEIGHT: 6 ½"



SP-520-52
HEIGHT: 6"
Table/Floor Spots

Black Finish

SWITCH: On 10' black cord,
18" from shade



Table/Floor Spots

SP-520-7
HEIGHT: 6"



Mini-cans

White Finish

SWITCH: On 10' white cord,
18" from shade

SP-512-9
HEIGHT: 6 ½"

SP-510-9
HEIGHT: 6 ½"



Table/Floor Spots

SP-520-9
HEIGHT: 6"

Bulbs
40R14N (included)

Advent™ Clip-on Light

Ideal for use with laptop computers, easels,
music stands and home office spaces.



ACL7-7

Finish
Black #7

Quality Features

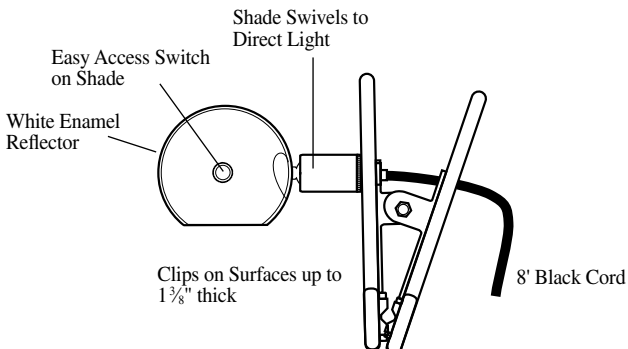

Littlite

High Intensity Halogen Lamp



HL3-12

Black Cord,
5' 9"

Finish
Black #7

Optional Accessory (Not Included)

RWB
Weighted
Base



Transformer, Snap Mount and Halogen bulb included

HSM (Included)

Snap Mount allows quick attachment and detachment of lamp. One half of the HSM adheres to the lamp base and the other to a flat surface. The lamp then snaps on and off as desired.

Product #	Bulb (included)	Gooseneck	Switch
HL3-12	5W	12"	dimmer
HL3-18	5W	18"	dimmer

Fluorescent PICTURE LIGHTS



Finishes

- Black #7
- White #9
- Satin Brass #51
- Satin Nickel #52
- Polished Brass #61
- Chrome #62
- Antique Brass #71
- Weathered Brass #76
- Oil Rubbed Bronze #91

NOTE: Custom orders available on request.

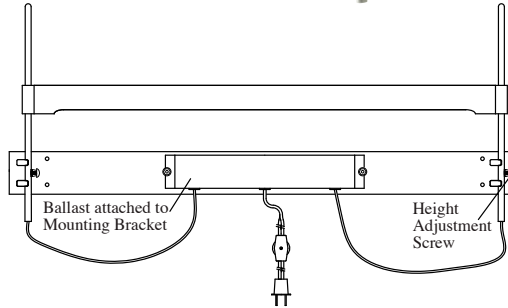
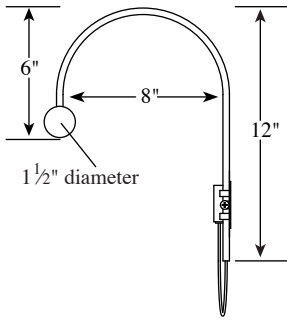

SIZE SELECTION
 Shade length should be one half the width of the image it is illuminating.

FLUORESCENT SPECIFICATIONS

Shade Size	Bulb	CRI	CCT	Watts	Lumens	Lifetime
24"	F14-T5	82	3000K	14	1200	15,000 hrs.
36"	F21-T5	82	3000K	21	1900	15,000 hrs.
48"	F28-T5	82	3000K	28	2600	15,000 hrs.

Bulbs not included. Non stock item, call for lead time and availability.

Direct Wire Fluorescent PICTURE LIGHTS



Finishes

- Satin Brass #51
- Satin Nickel #52
- Antique Brass #71

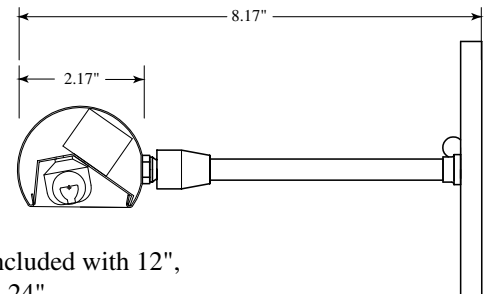

FLUORESCENT SPECIFICATIONS

Shade Size	Bulb	CRI	CCT	Watts	Lumens	Lifetime
12"	F8-T5	82	3000K	8	460	5,000 hrs.
24"	F14-T5	82	3000K	13	680	5,000 hrs.

Bulbs Included with 12", not with 24"

UC SERIES Under Cabinet Lights

- Line Voltage Incandescent System
- 10' Cord with Snap-on Plug
- Hardware to convert to Direct Wire
- 1 1/8" H x 1 3/4" D

UC-13-9

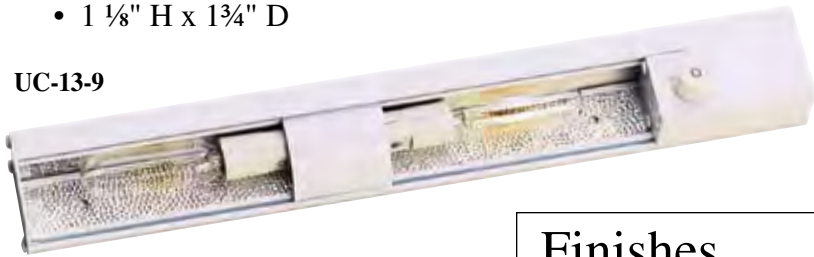

Specifications

Bulbs sold separately



UC 13"
two 25T6 bulbs



UC 18"
three 25T6 bulbs



UC 22"
four 25T6 bulbs



UC 28"
five 25T6 bulbs



UC 34"
six 25T6 bulbs



UC 45"
eight 25T6 bulbs

Finishes

- White #9
- Brushed Aluminum #32
- Polished Brass #61

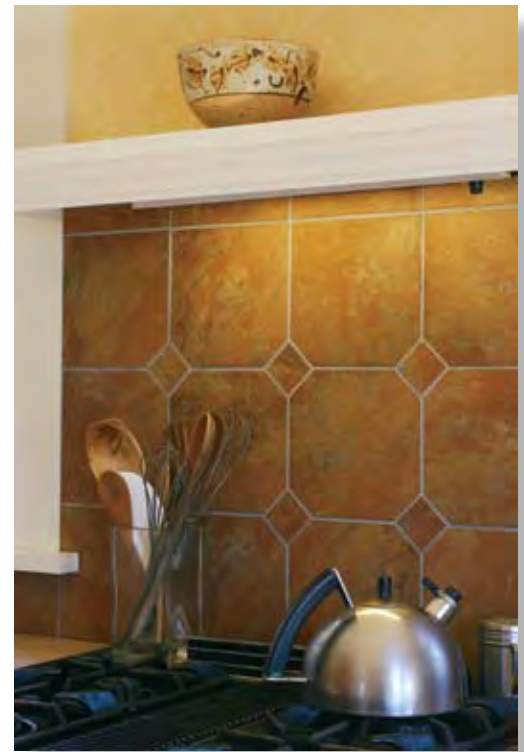

UC-18-32

Corridor Lights



← COR100-SN

FINISH: Satin Nickel w/ Art Glass
HEIGHT: 4 1/2"
EXTENSION: 3 3/4"
BACKPLATE: 4 1/2" x 4 1/2"
SHADE: 14"

COR100-SN shown
for unlit glass sample

← COR100-OB

FINISH: Oil Rubbed Bronze
w/ Art Glass
HEIGHT: 4 1/2"
EXTENSION: 3 3/4"
BACKPLATE: 4 1/2" x 4 1/2"
SHADE: 14"

↓ COR102-SN

FINISH: Satin Nickel
HEIGHT: 5 1/2"
EXTENSION: 3 1/4"
BACKPLATE: 5 1/2" Diameter
SHADE: 13"



↑ COR101-AB

FINISH: Antique Brass
HEIGHT: 4 1/2"
EXTENSION: 3 1/4"
BACKPLATE: 4 1/2" x 4 1/2"
SHADE: 14"

Finishes

- Antique Brass AB
- Oil Rubbed Bronze OB
- Satin Nickel SN

FLUORESCENT SPECIFICATIONS

Bulb	CRI	CCT	Watts	Lumens	Lifetime
F8T5-WW	82	3000K	8	460	5,000 hrs

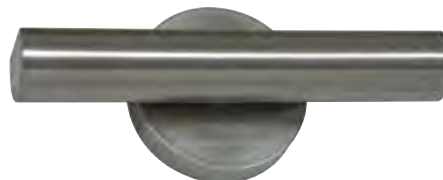

ADA
COMPLIANT

Product Finishes

Our Classic and Slim-line™ picture lights are offered in the most popular finishes. If you would like a finish that is not stocked, call our customer service department for lead time and cost.

The antique and weathered brass finishes are applied then rubbed by hand to achieve the proper effect. For this reason there are slight surface variations which are expected and desirable.

The stocked finishes are listed on the product page. Refer to this page for a color representation of finish.

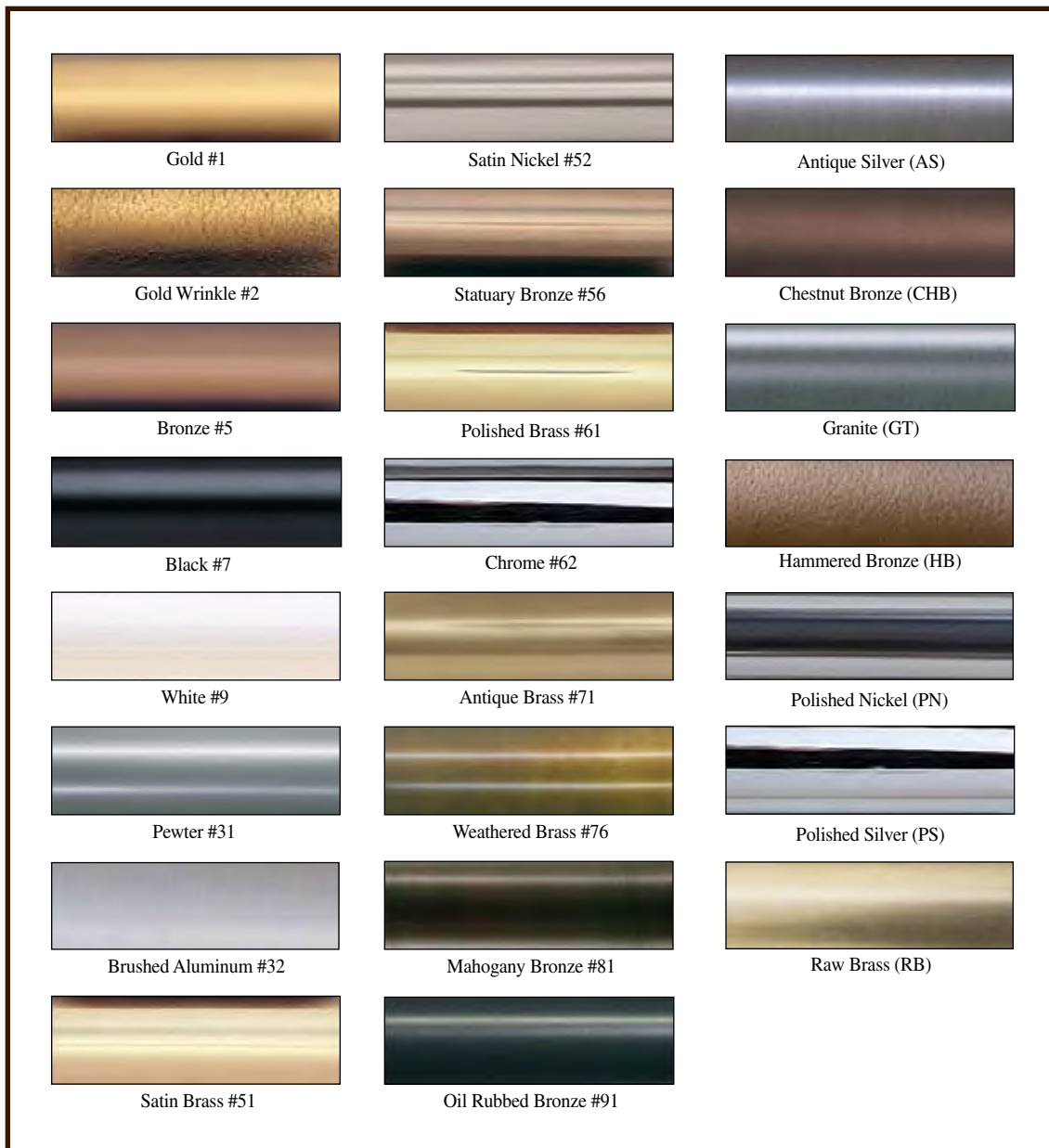

Custom Direct Mount Lighting

Customizing House of Troy Picture Lights.

We are often asked for custom versions of existing products, especially picture lights. Picture Lights are easily adapted to lighting book cases and display areas. We have developed hardware to mount through any hard surface. These products are designed as cord and plug items and will require a receptacle to plug them into behind the soffit. Call our Customer Service department at 800-428-5367 for assistance in designing your direct mount product.



CD-T24-81



CD-SL16-51

Illuminate bookshelves with our Slim-line Library Lighting. The slim lamp profile is designed for interiors where reduced lamp visibility is desired.

Slim-line™ Styles

Mounting Options

Arm Styles

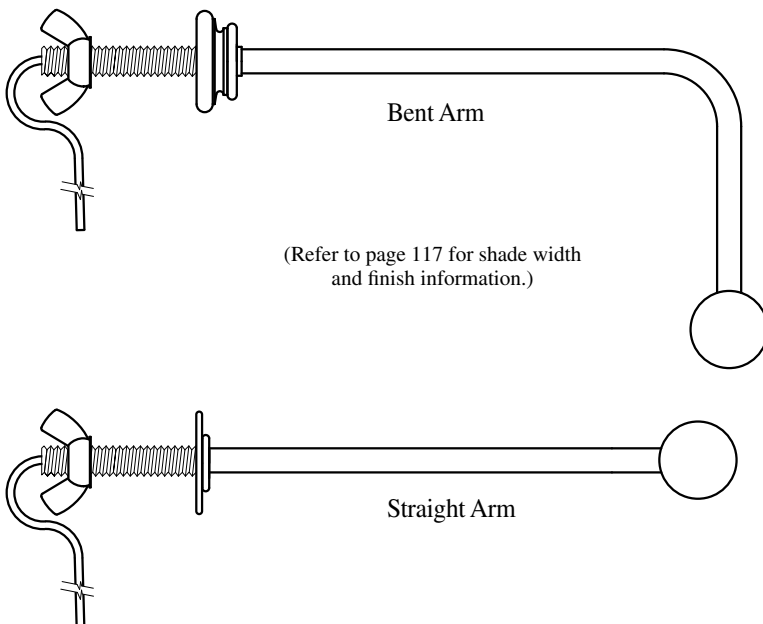



CD-DL10 -OB

Classic style lamps are an effective way to enhance traditional decor in either a residential or commercial setting.



Classic Styles

Mounting Options

Arm & Shade Styles

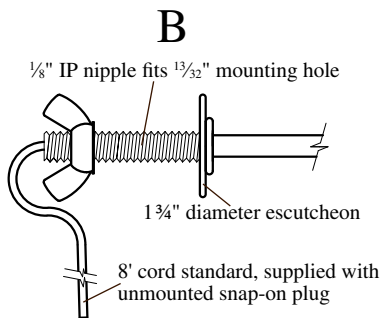
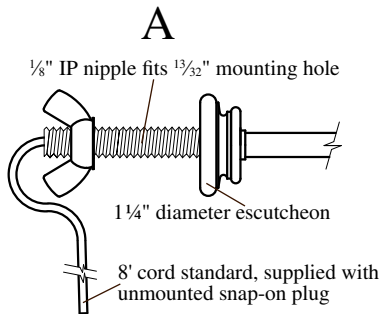

Traditional Shade
(Refer to page 113 for shade width and finish options.)

(Refer to page 115 for LED shade width and finish options.)

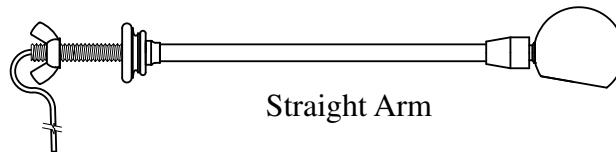

Contemporary Shade
(Refer to page 114 for shade width and finish options.)

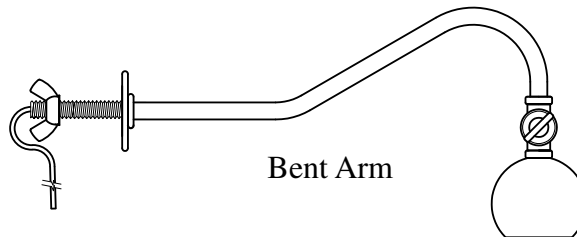

Hyde Park Shade
(Refer to page 116 for shade width and finish options.)

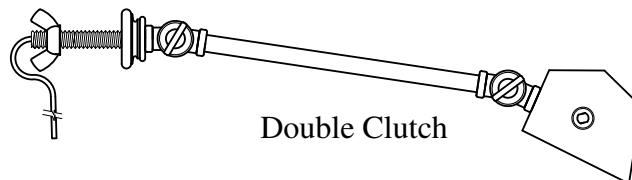

DL Shade
(Refer to page 69 for shade width and finish options.)

