

# ASSEMBLY INSTRUCTION

ITEM: 5878-10445-80 Bookcase

Thank you for purchasing this quality product. Be sure to unpack carefully looking for small parts which may have come loose during shipment. Read all instruction and study the drawing carefully before starting the assembly process.

NO.	DRAWING	DESCRIPTION	SIZE	Q'TY
A		Anti - Tip Kit		1PC

Tipping Restraint

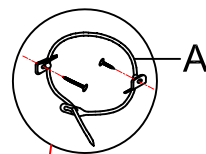

Anti-tip kit is included for use. We recommend installing for safety reason

Step 1

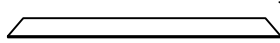

The adjustable glass shelf is packed in inner box to avoid damage during transit. Take out glass shelf from box and place it on wood shelf frame.

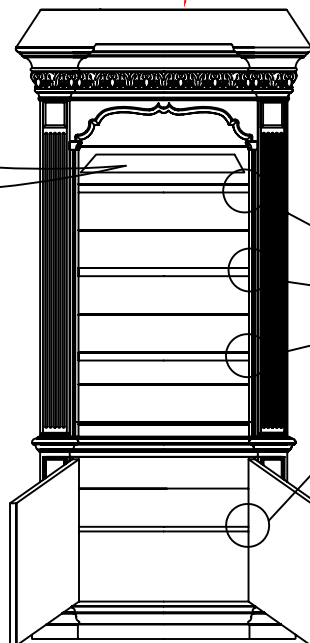

Step 2

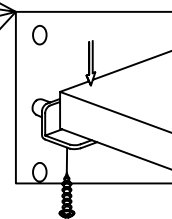

To adjust the shelf height, take out shelf pins then place shelf pins in the desired level.

Thank you for purchasing this quality product. Be sure to unpack carefully looking for small parts which may have come loose during shipment.  
Read all instruction and study the drawing carefully before starting the assembly process.

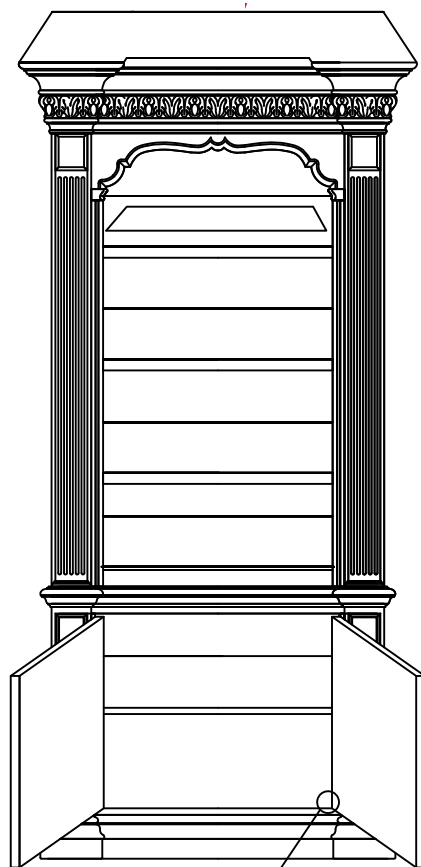

## Step 3

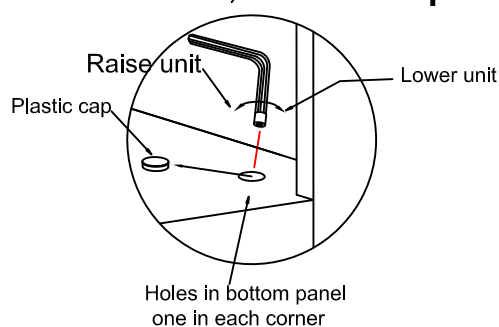

The instruction for using the interior levelers:

1. Take off the plastic caps.
2. Insert allen wrench through the holes into the heads of levelers. Turn clockwise to raise the furniture piece, counterclockwise to low it.
3. Adjust levelers until a level alignment is achieved.