











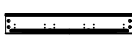











ITEM: 6700-90667-98 6/0-6/6 Poster Headboard
 6700-90668-98 6/0-6/6 Poster Footboard
 6700-90653-98 6/6 Rails and Canopy
 6700-90663-98 6/0 Rails and Canopy

Thank you for purchasing this quality product. Be sure to unpack carefully looking for small parts which may have come loose during shipment.
 Read all instruction and study the drawing carefully before starting the assembly process.

HARDWARE LIST					PARTS LIST			
NO.	DRAWING	DESCRIPTION	SIZE	Q'TY	NO.	DRAWING	DESCRIPTION	Q'TY
A		Threaded Rod	Ø3/8"*4"	12PCS	1		Headboard	1PC
B		Curved Washer	Ø3/8"	12PCS	2		Rail	2PCS
C		Nut	Ø3/8"	12PCS	3		Footboard	1PC
D		Open Wrench	Ø3/8"	1PC	4		Footboard Post	2PCS
E		Screw	8*32mm	20PCS	5		Support Leg	5PCS
F		Allen Wrench	4mm	1PC	6		Canopy Rail	2PCS
G		Bolt	Ø1/4"	10PCS	7		Canopy Rail	2PCS
H		Lock Washer	Ø1/4"	10PCS	8		Slat	5PCS
I		Flat Washer	Ø1/4"	10PCS	9		Top Post	4PCS
J		Allen Wrench	5mm	1PC	10		Metal Collar	4PCS
K		Bolt	5/16*200mm	4PCS				
L		Lock Washer	Ø5/16"	4PCS				
M		Flat Washer	Ø5/16"	4PCS				

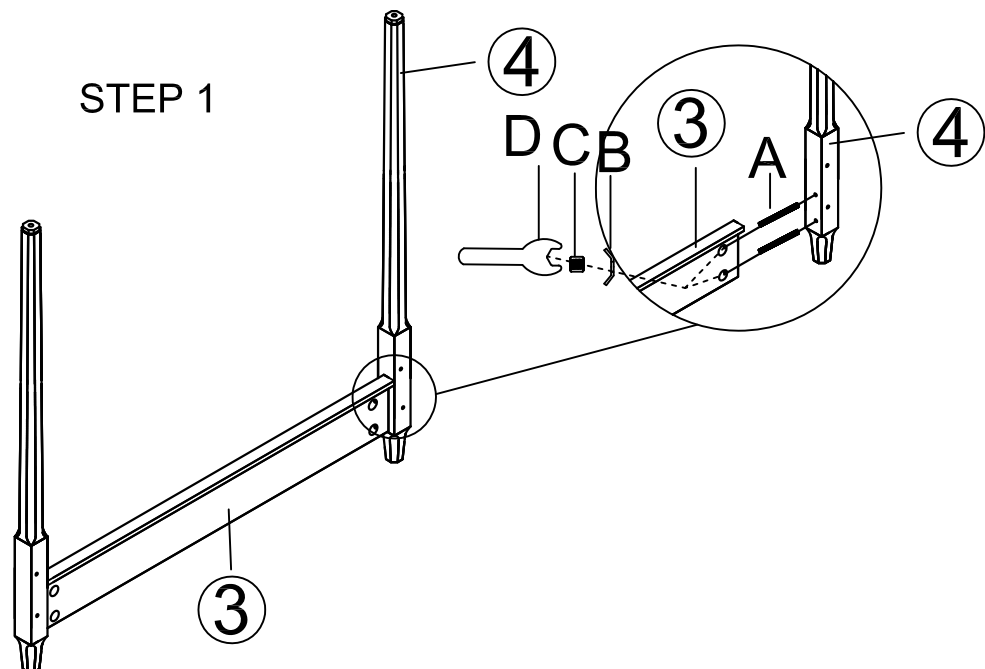

ASSEMBLY INSTRUCTION

ITEM: 6700-90667-98 6/0-6/6 Poster Headboard
 6700-90668-98 6/0-6/6 Poster Footboard
 6700-90653-98 6/6 Rails and Canopy
 6700-90663-98 6/0 Rails and Canopy

Thank you for purchasing this quality product. Be sure to unpack carefully looking for small parts which may have come loose during shipment.
 Read all instruction and study the drawing carefully before starting the assembly process .

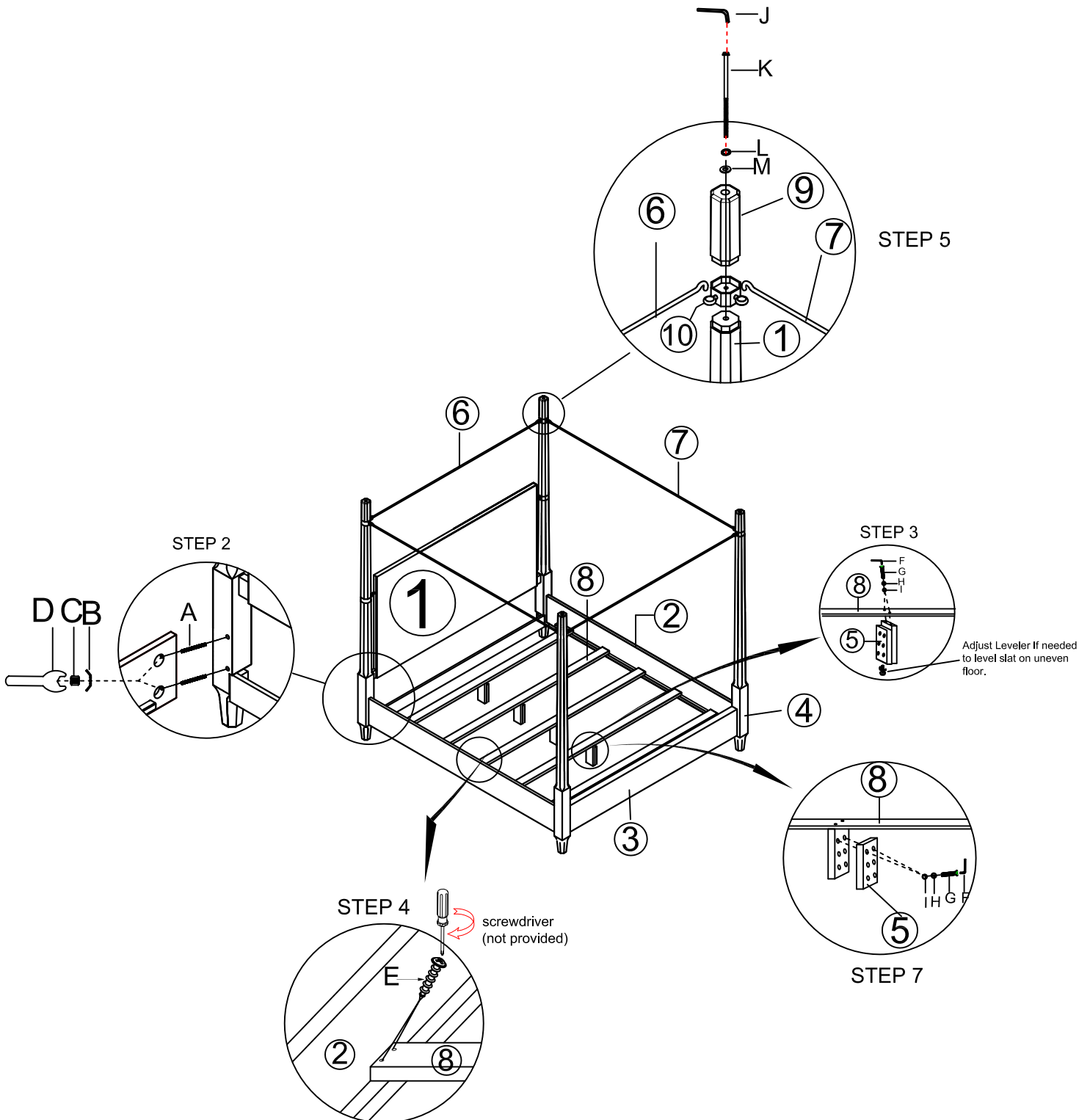

ITEM: 6700-90667-98 6/0-6/6 Poster Headboard
6700-90668-98 6/0-6/6 Poster Footboard
6700-90653-98 6/6 Rails and Canopy
6700-90663-98 6/0 Rails and Canopy

Thank you for purchasing this quality product. Be sure to unpack carefully looking for small parts which may have come loose during shipment.
Read all instruction and study the drawing carefully before starting the assembly process .

Step 1: Attach footboard posts (4) to footboard (3).

Step 2: Attach rails (2) to headboard (1) and footboard (3) by using threaded rods (A), curved washers (B) and nuts (C), tighten them with open wrench (D).

Step 3: Attach support legs (5) to slats (8).

Step 4: Attach slats (8) to the rails (2) and tighten them by using Phillips head screwdriver.

Step 5: Put the metal collars (10) on the posts of headboard (1), then hang the canopy rails (6 & 7) to the metal collars (10). Well secure the top posts (9) and metal collars (10) to headboard posts (1) with bolts (K), lock washers (L) and flat washers (M), tighten all with allen wrench (J).

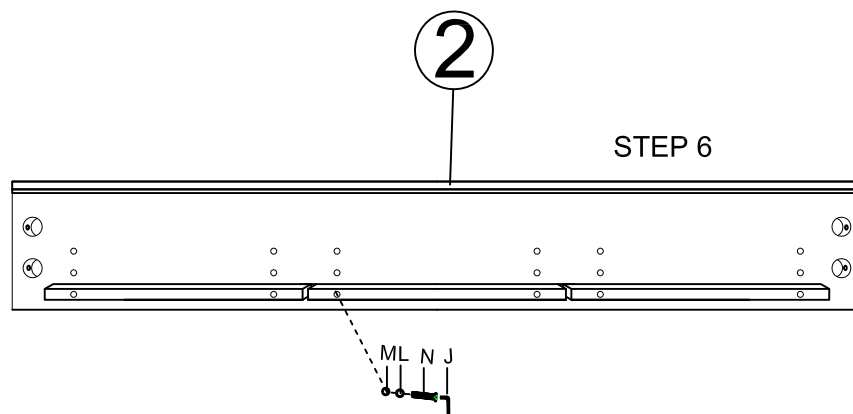

Note 1: You can change the height of slats (8) by adjusting the height of cleats on side rail (2) as shown in Step 6.

Remove bolts (N), lock washers (L) and flat washers (M) from the cleats by using allen wrench (J). Adjust the cleats to a desired position, then secure flat washers (M), lock washers (L) and bolts (N) by using allen wrench (J).

Note 2: You can adjust the height of support legs (5) as shown in Step 7.

Unscrew bolts (G), lock washers (H) and flat washers (I) on support legs (5) with allen wrench (F). Adjust the height of support legs (5), align holes on 2pcs of woods and tighten them together with 2 bolts (G), 2 lock washers (H) and 2 flat washers (I) by using allen wrench (F).