















# ASSEMBLY INSTRUCTION

ITEM: 6700-90251-80 5/0 Panel Headboard  
 6700-90252-80 5/0 Panel Footboard  
 6700-90267-80 6/0-6/6 Panel Headboard  
 6700-90268-80 6/0-6/6 Panel Footboard  
 6700-90253-80 5/0-6/6 Rails  
 6700-90263-80 6/0 Rails

Thank you for purchasing this quality product. Be sure to unpack carefully looking for small parts which may have come loose during shipment.  
 Read all instruction and study the drawing carefully before starting the assembly process .

HARDWARE LIST					PARTS LIST			
NO.	DRAWING	DESCRIPTION	SIZE	Q'TY	NO.	DRAWING	DESCRIPTION	Q'TY
A		Threaded rod	Ø3/8"*4"	8PCS	1		Headboard	1PC
B		Curved Washer	Ø3/8"	8PCS	2		Rail	2PCS
C		Nut	Ø3/8"	8PCS	3		Footboard	1PC
D		Open Wrench	Ø3/8"	1PC	4		Slat	4PCS (for 5/0 bed) 5PCS (for 6/6 & 6/0 beds)
E		Screw	8*32MM	16PCS (for 5/0 bed) 20PCS (for 6/6 & 6/0 beds)	5		Support Leg	4PCS (for 5/0 bed) 5PCS (for 6/6 & 6/0 beds)
F		Allen Wrench	4MM	1PC				
G		Bolt	Ø1/4"	8PCS (for 5/0 bed) 10PCS (for 6/6 & 6/0 beds)				
H		Lock Washer	Ø1/4"	8PCS (for 5/0 bed) 10PCS (for 6/6 & 6/0 beds)				
I		Flat Washer	Ø1/4"	8PCS (for 5/0 bed) 10PCS (for 6/6 & 6/0 beds)				
J		Allen Wrench	5MM	1PC				

Step 1: Attach Rails (2) to Headboard (1) and Footboard (3) by using Threaded Rods (A), Curved Washers (B), and Nuts (C), tighten them with Open Wrench (D) .

Step 2: Attach support legs (5) to slats (4).

Step 3: Attach slats (4) to the rails (2) and tighten them by using Phillips head screwdriver.

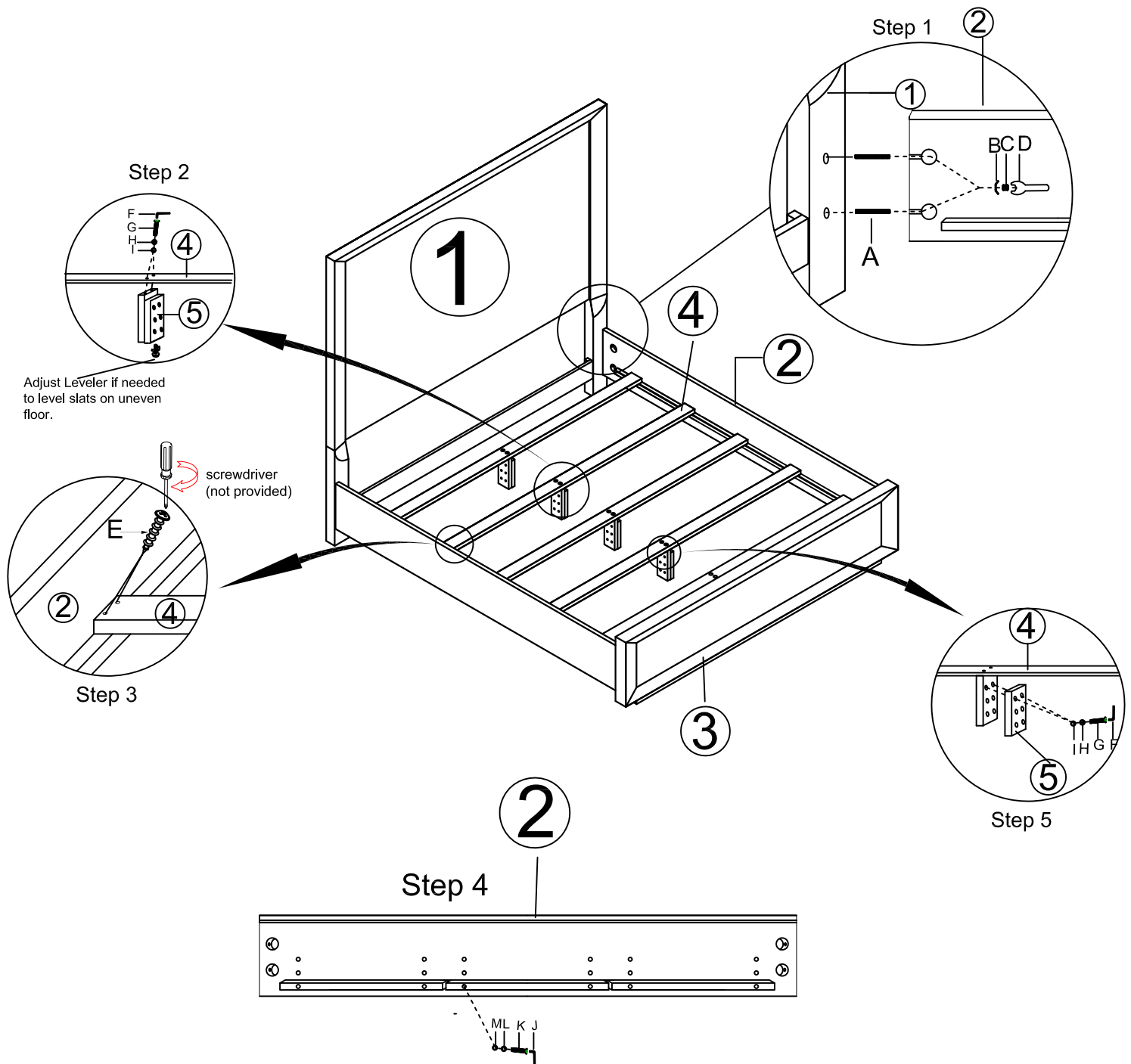

**Note 1:** You can change the height of slats (4) by adjusting the height of cleats on side rail (2) as shown in Step 4.

Remove bolts (K), lock washers (L) and flat washers (M) from the cleats by using allen wrench (J). Adjust the cleats to a desired position, then secure flat washers (M), lock washers (L) and bolts (K) by using allen wrench (J).

**Note 2:** You can adjust the height of support legs (5) as shown in Step 5.

Unscrew bolts (G), lock washers (H) and flat washers (I) on support legs (5) with allen wrench (F). Adjust the height of support legs (5), align holes on 2pcs of woods and tighten them together with 2 bolts (G), 2 lock washers (H) and 2 flat washers (I) by using allen wrench (F).