

# ASSEMBLY INSTRUCTION







ITEM: 6700-75207-80 Leg Table w/1-24 in leaf

Thank you for purchasing this quality product. Be sure to unpack carefully looking for small parts which may have come loose during shipment.

Read all instruction and study the drawing carefully before starting the assembly process.

PART LIST

PART LIST

NO.	DRAWING	DESCRIPTION	SIZE	Q'TY	NO.	DRAWING	DESCRIPTION	Q'TY
A		Allen Wrench	5mm	1PC	①		Leg	4PCS
B		Bolt	$\frac{5}{16}$ "	8PCS	②		Top	1PC
C		Lock Washer	$\frac{5}{16}$ "	8PCS	③		Leaf	1PC
D		Flat Washer	$\frac{5}{16}$ "	8PCS				

**Note: Follow numbers on legs (1) and corner blocks during assembly.**

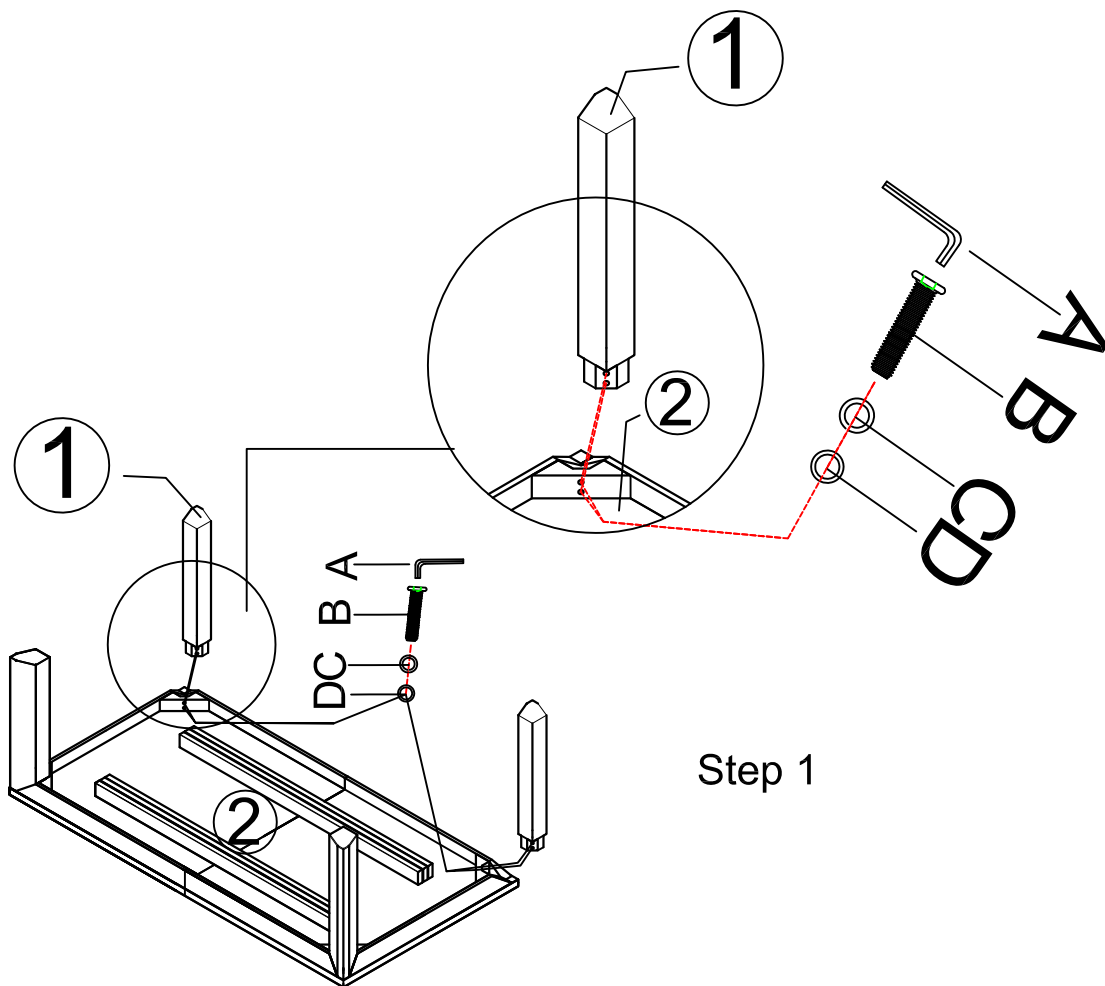

Diagram 1

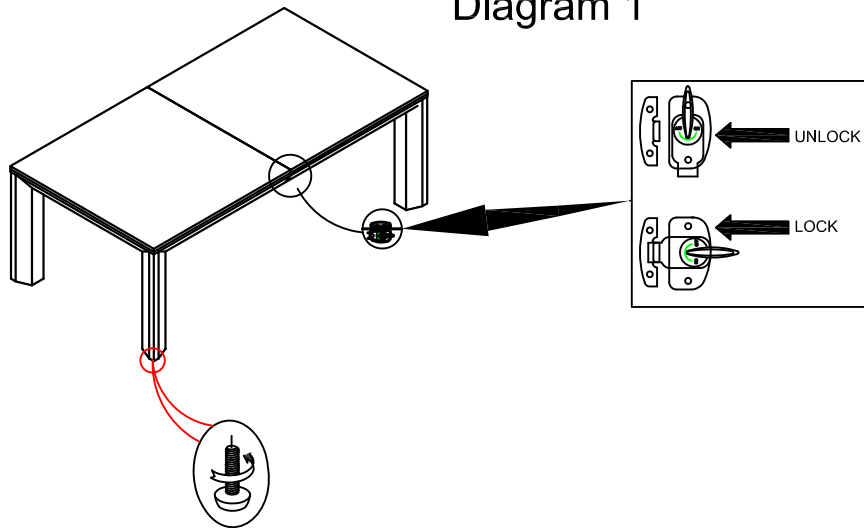
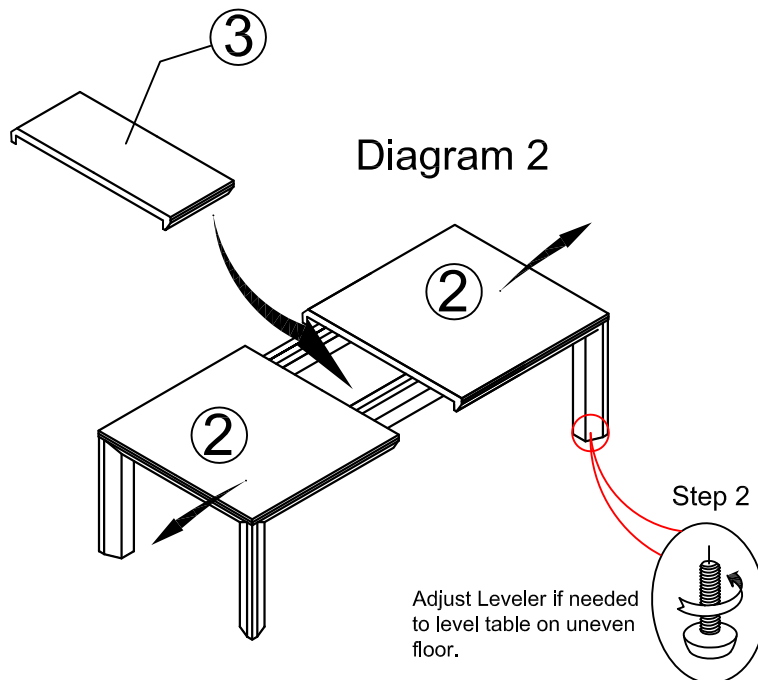

Diagram 2



**Instruction for table leaf:**

1. There are latches at the bottom of table top, unlock the latches as shown in Diagram 1 above.
2. Pull out table top as the arrow direction shown in Diagram 2.
3. Place table leaf (3) between table tops and push table tops together.
4. Lock the latches. (See Diagram 1)
5. Take opposite actions to remove table leaf.