







Item: 6150-90451-85 Boones 5/0 Upholstered Sleigh Headboard
 6150-90452-85 Boones 5/0 Upholstered Sleigh Footboard
 6150-90453-85 Boones 5/0-6/6 Upholstered Rails

Thank you for purchasing this quality product. Be sure to unpack carefully looking for small parts which may have come loose during shipment.

Read all instruction and study the drawing carefully before starting the assembly process:

HARDWARE PACK

NO	DRAWING	DESCRIPTION	SIZE	Q'TY
A		Wrench	12mm	1pc
B		Nut	Ø5/16*12	8pcs
C		Lock Washer	Ø5/16"*12*3	8pcs
D		Curved Washer	L32*13*8	8pcs
E		Threaded Rod	Ø5/16"*4-1/2"	8pcs
F		Screw	8#*1"	10pcs

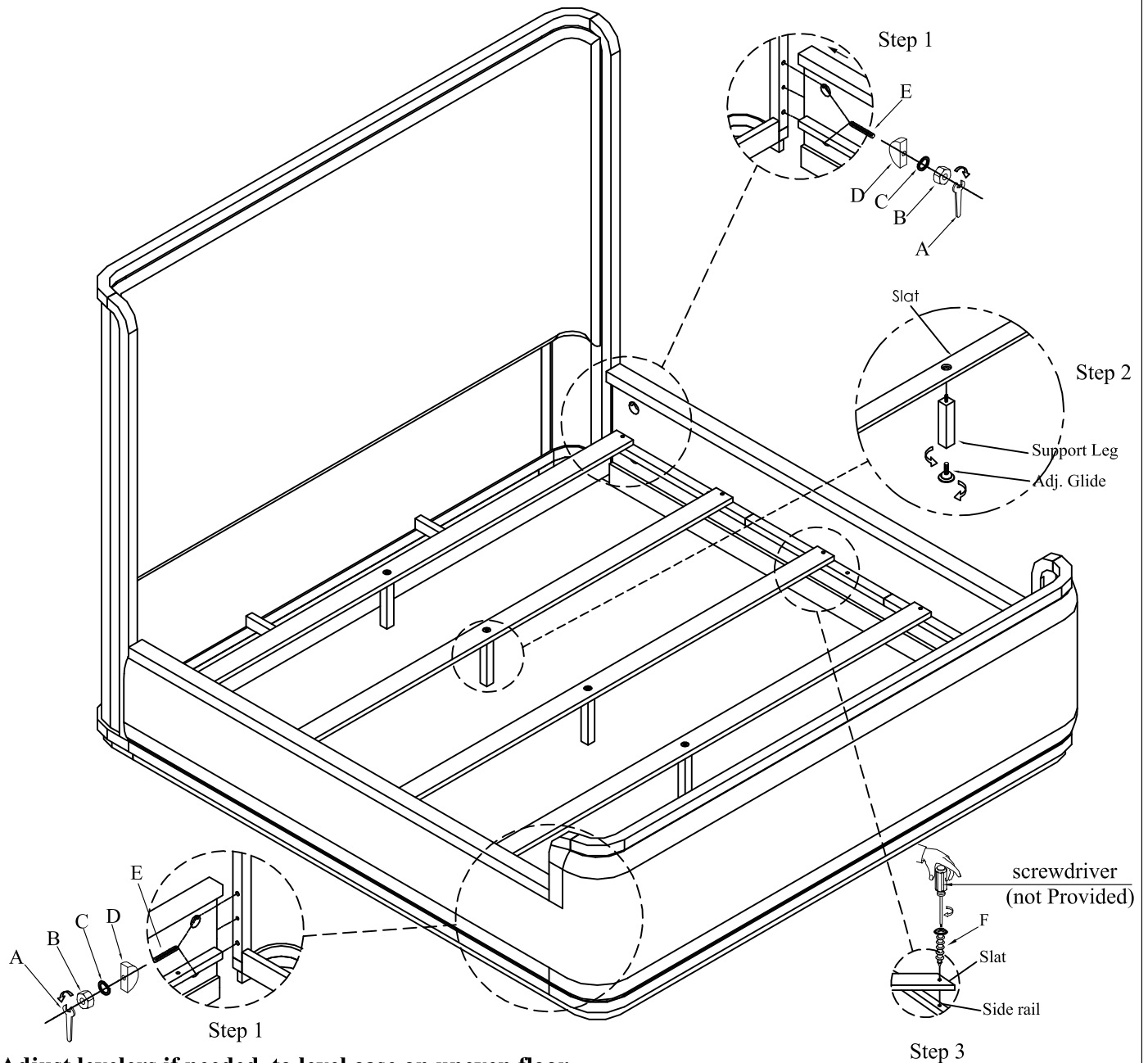

Adjust levelers if needed, to level case on uneven floor