







# ASSEMBLY INSTRUCTION

ITEM: 5961-90002-02 Six-Drawer Dresser  
 5961-90002-89 Six-Drawer Dresser  
 5961-90004-89 Landscape Mirror

Thank you for purchasing this quality product. Be sure to unpack carefully looking for small parts which may have come loose during shipment.

Read all instruction and study the drawing carefully before starting the assembly process.

### HARDWARE PACK

NO.	DRAWING	DESCRIPTION	SIZE	Q'TY
A		Flat Washer	1/4"	8PCS
B		Lock Washer	1/4"	8PCS
C		Bolt	1/4"	8PCS
D		Allen Wrench	69mm	1PC
E		Hook	4*53mm	2PCS
F		Plastic Anchor	∅ 9*30mm	2PCS
G		Anti - Tip Kit		1PC

### PART LIST

NO.	DRAWING	DESCRIPTION	Q'TY
①		Mirror Support	2PCS

**Note: 5961-90002-02 / 89 can be assembled with 5961-90004-89 or 5961-90007-02 / 89.**

### STEP 2

When using mirror only, hang the metal ring (H) onto the hook (E).

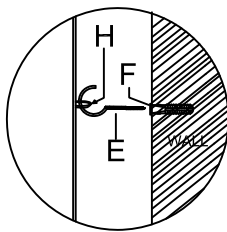

Anti-tip kit is included for use. We recommend installing for safety reason.

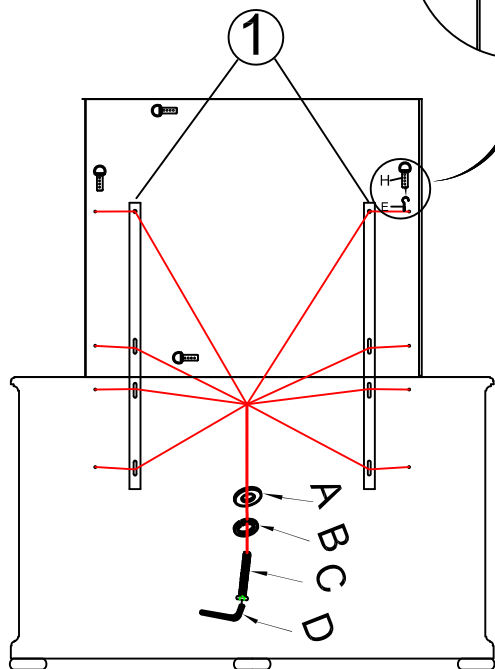

### STEP 1

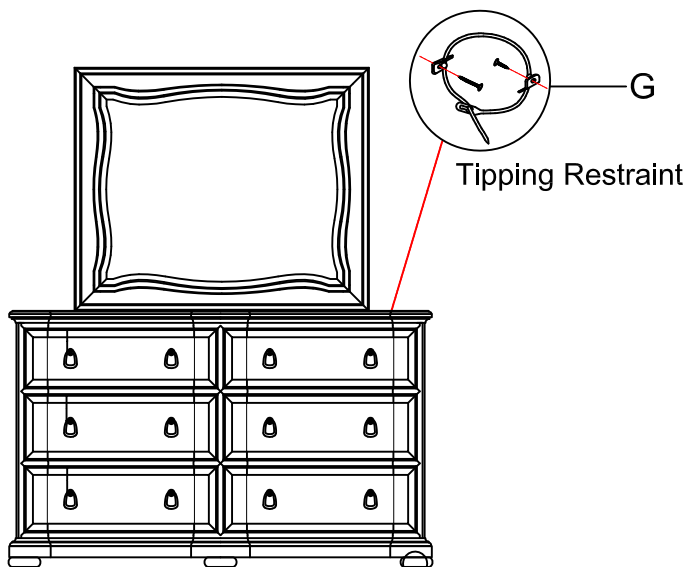

### STEP 3

Adjust Leveler if needed to level case on uneven floor.

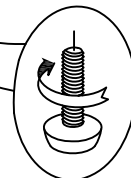







Note: Anti-tip kit restraint is provided. Please follow the instructions enclosed with the pack.

ITEM: 5961-90002-02 Six-Drawer Dresser  
 5961-90002-89 Six-Drawer Dresser  
 5961-90007-02 Round Mirror  
 5961-90007-89 Round Mirror

Thank you for purchasing this quality product. Be sure to unpack carefully looking for small parts which may have come loose during shipment.  
 Read all instruction and study the drawing carefully before starting the assembly process.

### HARDWARE PACK

### PART LIST

NO.	DRAWING	DESCRIPTION	SIZE	Q'TY
A		Flat Washer	1/4"	4PCS
B		Lock Washer	1/4"	4PCS
C		Bolt	1/4"	4PCS
D		Allen Wrench	69mm	1PC
E		Hook	4*53mm	2PCS
F		Plastic Anchor	∅ 9*30mm	2PCS
G		Anti - Tip Kit		1PC

NO.	DRAWING	DESCRIPTION	Q'TY
①		Mirror Support	1PC

**Note: 5961-90002-02 / 89 can be assembled with 5961-90004-89 or 5961-90007-02 / 89.**

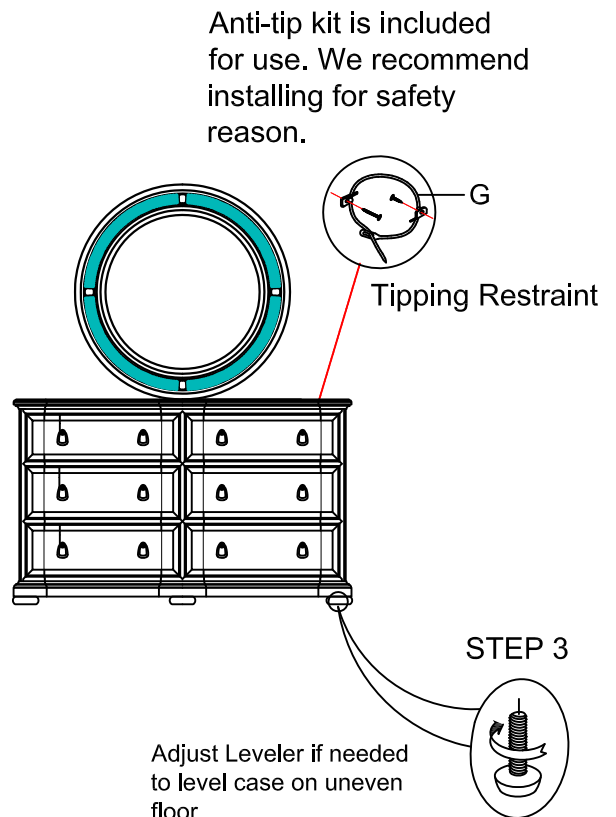
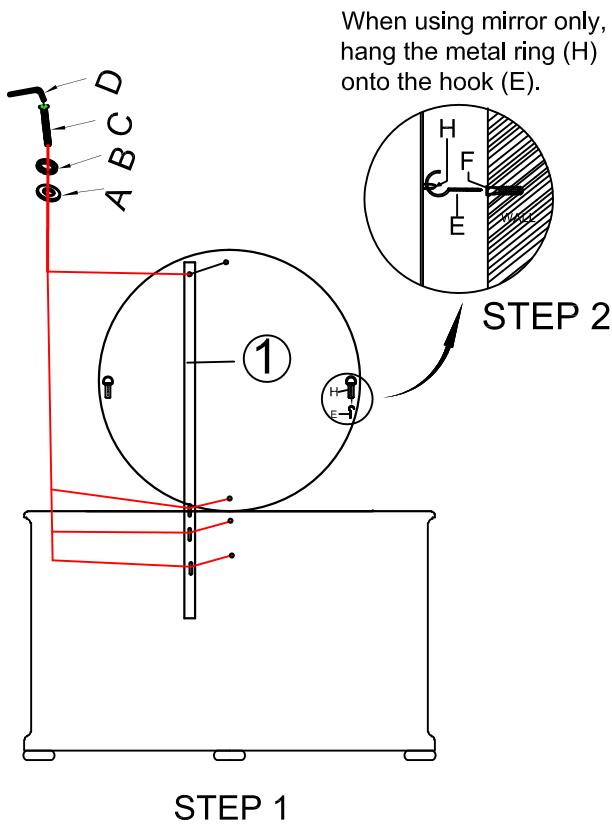

Note: Anti-tip kit restraint is provided. Please follow the instructions enclosed with the pack.