











# ASSEMBLY INSTRUCTION

ITEM: 5961-80161-02 Console Table  
 5961-80161-35 Console Table  
 5961-80161-89 Console Table

Thank you for purchasing this quality product. Be sure to unpack carefully looking for small parts which may have come loose during shipment.  
 Read all instruction and study the drawing carefully before starting the assembly process.

HARDWARE PACK				
NO.	DRAWING	DESCRIPTION	SIZE	Q'TY
A		Allen Wrench	73*29*5mm	1PC
B		Bolt	Ø5/16"	12PCS
C		Lock Washer	Ø5/16"	12PCS
D		Flat Washer	Ø5/16"	12PCS
E		Adjustable Leveler	1/4*1"	6PCS
F		Wrench	100*40*10mm	1PC
G		Bolt	∅ 14mm	6PCS

PART LIST			
NO.	DRAWING	DESCRIPTION	Q'TY
1		Foot	6PCS
2		Bottom Panel	1PC
3		Post	6PCS
4		Top Panel	1PC

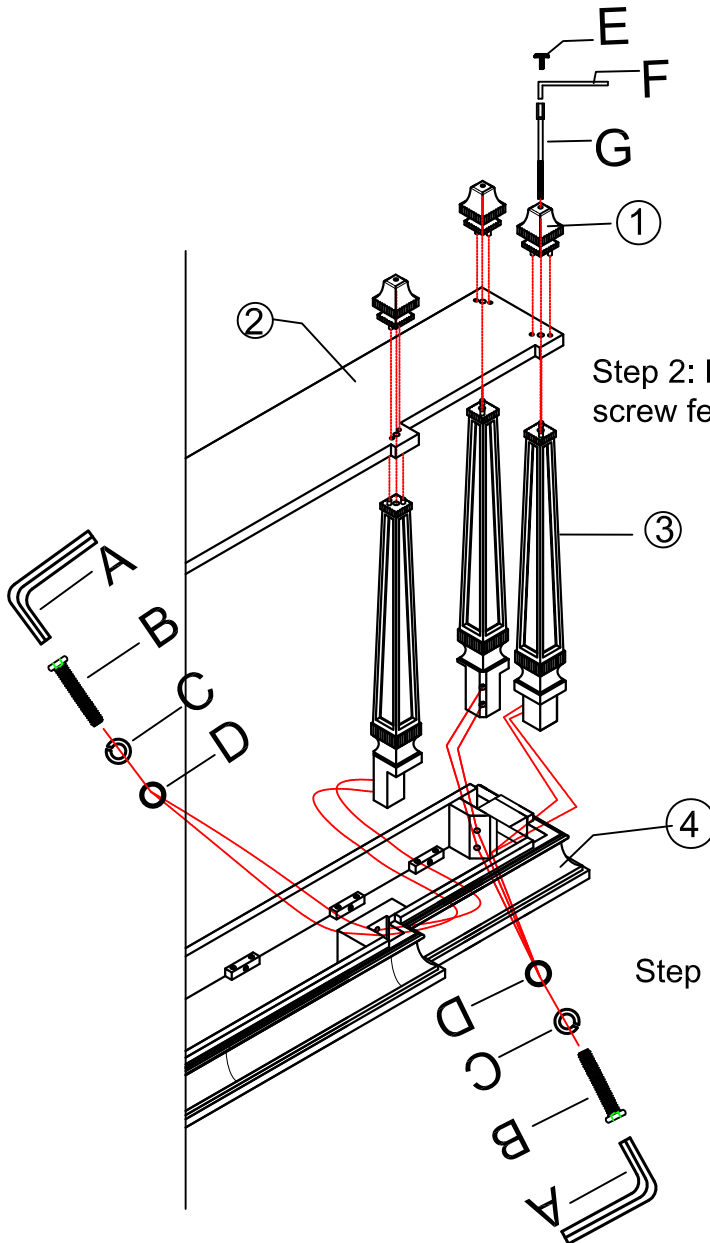

Step 3: Screw adjustable levelers (E) into bolts of feet (G) by turning with clockwise direction.

Step 2: Place bottom panel (2) on posts (3), screw feet (1) through bottom panel to posts.

Step 1: Attach posts (3) to top panel (4).

# ASSEMBLY INSTRUCTION

ITEM: 5961-80161-02 Console Table  
5961-80161-35 Console Table  
5961-80161-89 Console Table

Thank you for purchasing this quality product. Be sure to unpack carefully looking for small parts which may have come loose during shipment.  
Read all instruction and study the drawing carefully before starting the assembly process.

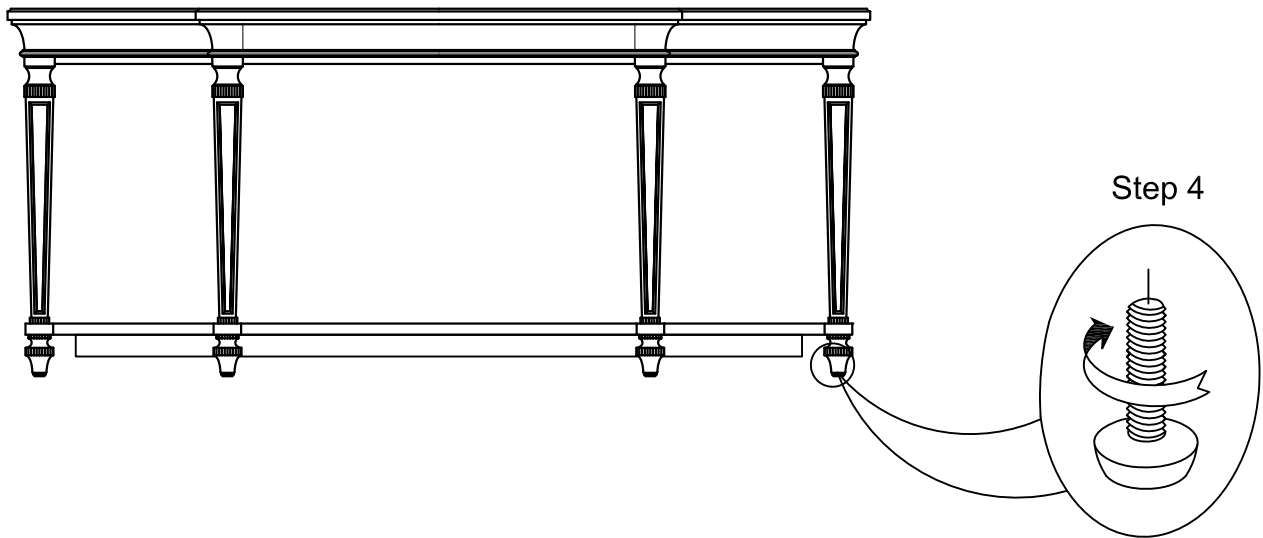

Adjust Leveler if needed to level table on uneven floor.