













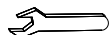

ASSEMBLY INSTRUCTION

ITEM: 6025-90251-83 Lauro 5/0 Panel Headboard
 6025-90252-83 Lauro 5/0 Panel Footboard
 6025-90253-83 Lauro 5/0-6/6 Rail
 6025-90267-83 Lauro 6/0-6/6 Panel Headboard with Metal
 6025-90268-83 Lauro 6/0-6/6 Panel Footboard
 6025-90263-83 Lauro 6/0 Rail

Thank you for purchasing this quality product. Be sure to unpack carefully looking for small parts which may have come loose during shipment.

Read all instruction and study the drawing carefully before starting the assembly process.

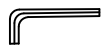
HARDWARE LIST					PARTS LIST			
NO.	DRAWING	DESCRIPTION	SIZE	Q'TY	NO.	DRAWING	DESCRIPTION	Q'TY
A		Threaded rod	Ø3/8"*4"	8PCS	1		Headboard	1PC
B		Curved Washer	Ø3/8"	8PCS	2		Rail	2PCS
C		Nut	Ø3/8"	8PCS	3		Footboard	1PC
D		Open Wrench	Ø3/8"	1PC	4		Slat	5PCS (FOR 6/6 & 6/0 BED) 4PCS (FOR 5/0 BED)
E		Screw	8*32MM	20PCS (FOR 6/6 & 6/0 BED) 16PCS (FOR 5/0 BED)	5		Support leg	5PCS (FOR 6/6 & 6/0 BED) 4PCS (FOR 5/0 BED)
F		Allen Wrench	4MM	1PC				
G		Bolt	1/4"*35MM	10PCS (FOR 6/6 & 6/0 BED) 8PCS (FOR 5/0 BED)				
H		Lock Washer	Ø1/4"	10PCS (FOR 6/6 & 6/0 BED) 8PCS (FOR 5/0 BED)				
I		Flat Washer	Ø1/4"	10PCS (FOR 6/6 & 6/0 BED) 8PCS (FOR 5/0 BED)				
J		Allen Wrench	5MM	1PC				

Please note the hardware bag to assemble side rail to HB & FB is in the box of side rails.

Step 1: Insert 2 threaded rods (A) into holes of each side post of headboard (1) and footboard (3), attach ends of side rails (2) to threaded rods (A) on posts by using 2 curved washers (B) and 2 nuts (C), tighten nuts (C) securely by using allen wrench (D).

Step 2: Take out support legs (5) from the rail box, attach support legs (5) to slats (4) by using 2 flat washers (I), 2 lock washers (H) and 2 bolts (G). Secure bolts (G) by using allen wrench (F).

Step 3: Attach slats (4) to side rails (2), align pre-drilled holes on the slats (4) to holes on the cleats of side rails (2), using screws (E) to tighten both.

ASSEMBLY INSTRUCTION

ITEM: 6025-90251-83 Lauro 5/0 Panel Headboard
 6025-90252-83 Lauro 5/0 Panel Footboard
 6025-90253-83 Lauro 5/0-6/6 Rail
 6025-90267-83 Lauro 6/0-6/6 Panel Headboard with Metal
 6025-90268-83 Lauro 6/0-6/6 Panel Footboard
 6025-90263-83 Lauro 6/0 Rail

Thank you for purchasing this quality product. Be sure to unpack carefully looking for small parts which may have come loose during shipment.
 Read all instruction and study the drawing carefully before starting the assembly process.

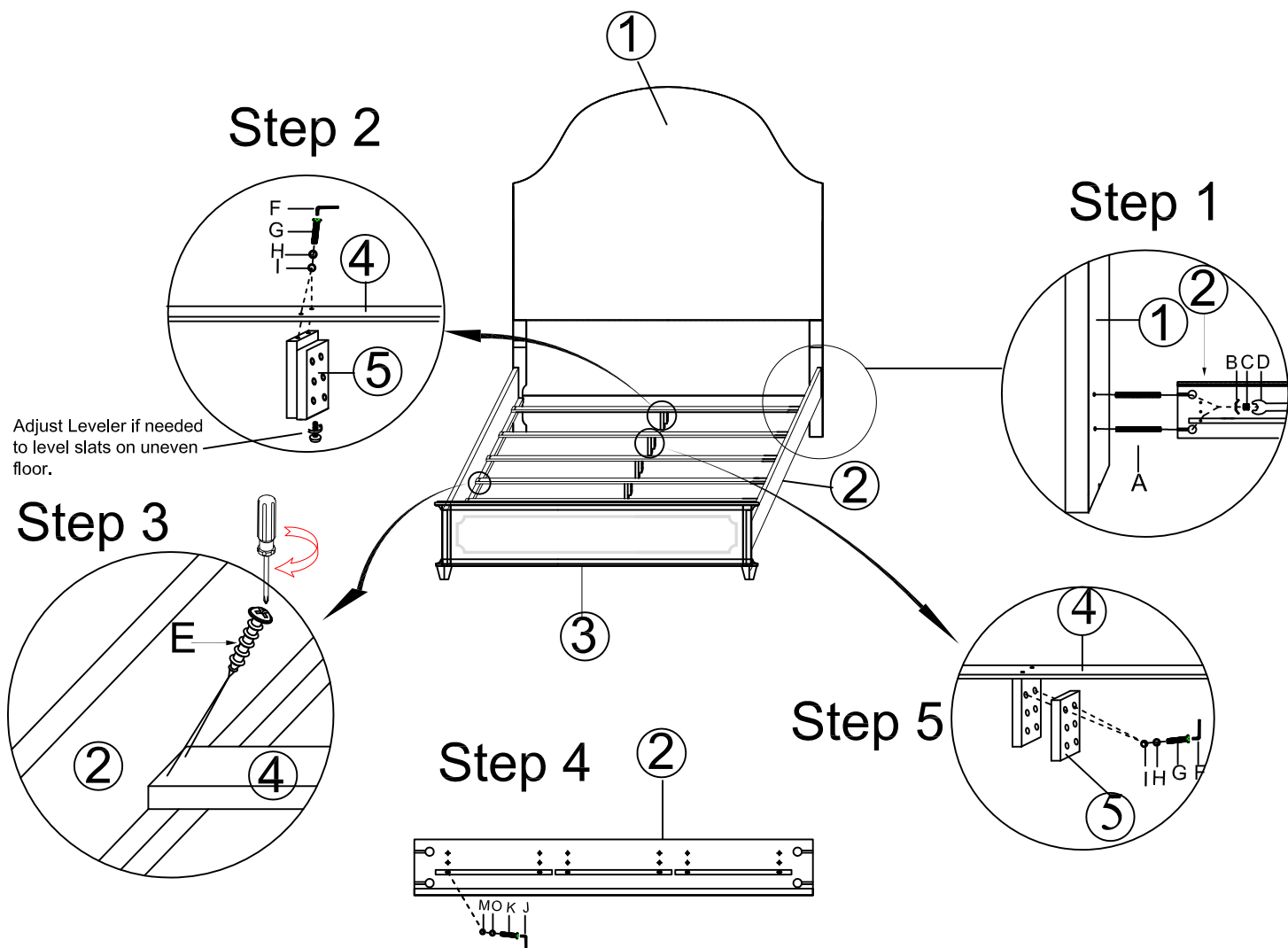

Adjust Leveler if needed to level slats on uneven floor.

Note 1: You can change the height of slats (4) by adjusting the height of cleats on side rail (2) as shown in Step 4.

Remove bolts (K), lock washers (O) and flat washers (M) from the cleats by using allen wrench (J). Adjust the cleats to a desired position, then secure flat washers (M), lock washers (O) and bolts (K) by using allen wrench (J).

Note 2: You can adjust the height of support legs (5) as shown in Step 5.

Unscrew bolts (G), lock washers (H) and flat washers (I) on support legs (5) with allen wrench (F). Adjust the height of support legs (5), align holes on 2pcs of woods and tighten them together with 2 bolts (G), 2 lock washers (H) and 2 flat washers (I) by using allen wrench (F).