





Thank you for purchasing this quality product. Be sure to unpack carefully looking for small parts which may have come loose during shipment. Read all instruction and study the drawing carefully before starting the assembly process.

HARDWARE PACK

NO	DRAWING	DESCRIPTION	SIZE	Q'ty	PARTS LIST			
A		Anti - Tip Kit		1pc	NO.	DRAWING	DESCRIPTION	Q'TY
					1		BOTTOM PANEL	1PC
					2		POST	4PCS
					3		FOOT	4PCS
					4		TOP	1PC

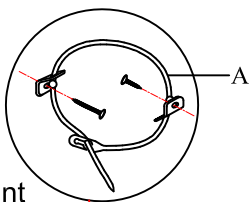
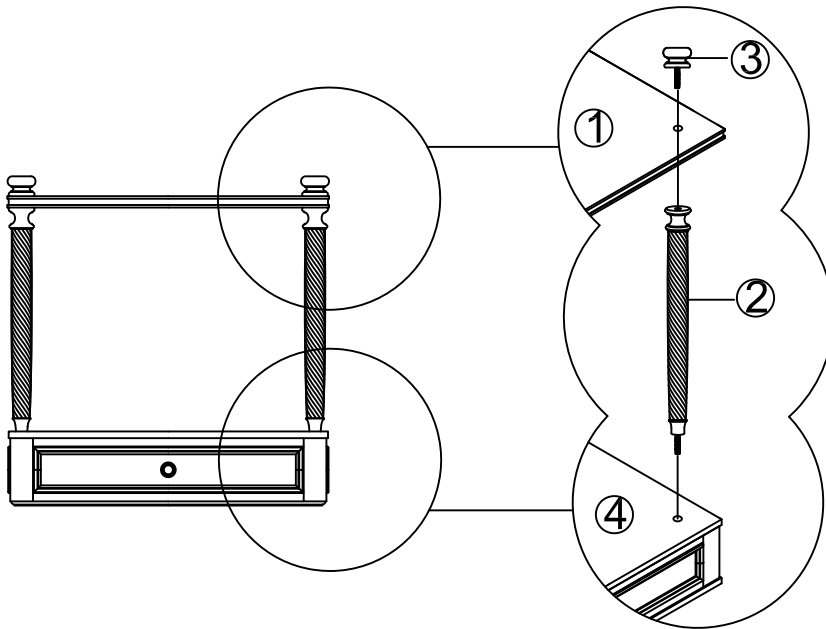

Tipping Restraint

Anti-tip kit is included for use. We recommend installing for safety reason

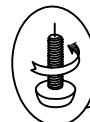
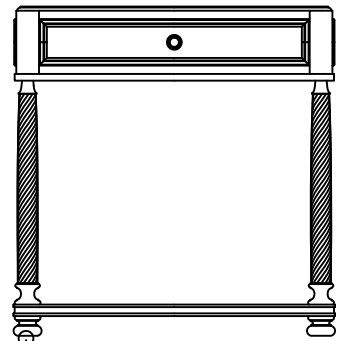
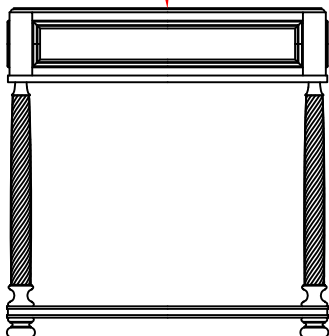

Adjust Leveler if needed to level base on uneven floor.