







## Item: 6201-75400 MULTI Sandro Arm Chair

Thank you for purchasing this quality product. Be sure to unpack carefully looking for small parts which may have come loose during shipment.

Read all instruction and study the drawing carefully before starting the assembly process:

### HARDWARE PACK

NO	DRAWING	DESCRIPTION	SIZE	Q'TY
A		Screw	8#*1-1/2"	2pcs
B		Hexagonal Bolt	Ø5/16"*3-1/2"	4pcs
C		Hexagonal Bolt	Ø5/16"*1-1/2"	2pcs
D		Flat Washer	Ø5/16"*19*2	10pcs
E		Lock Washer	Ø5/16"*12*3	10pcs
F		Nut	Ø5/16"*12	4pcs
G		Hex Wrench	12MM	1pc

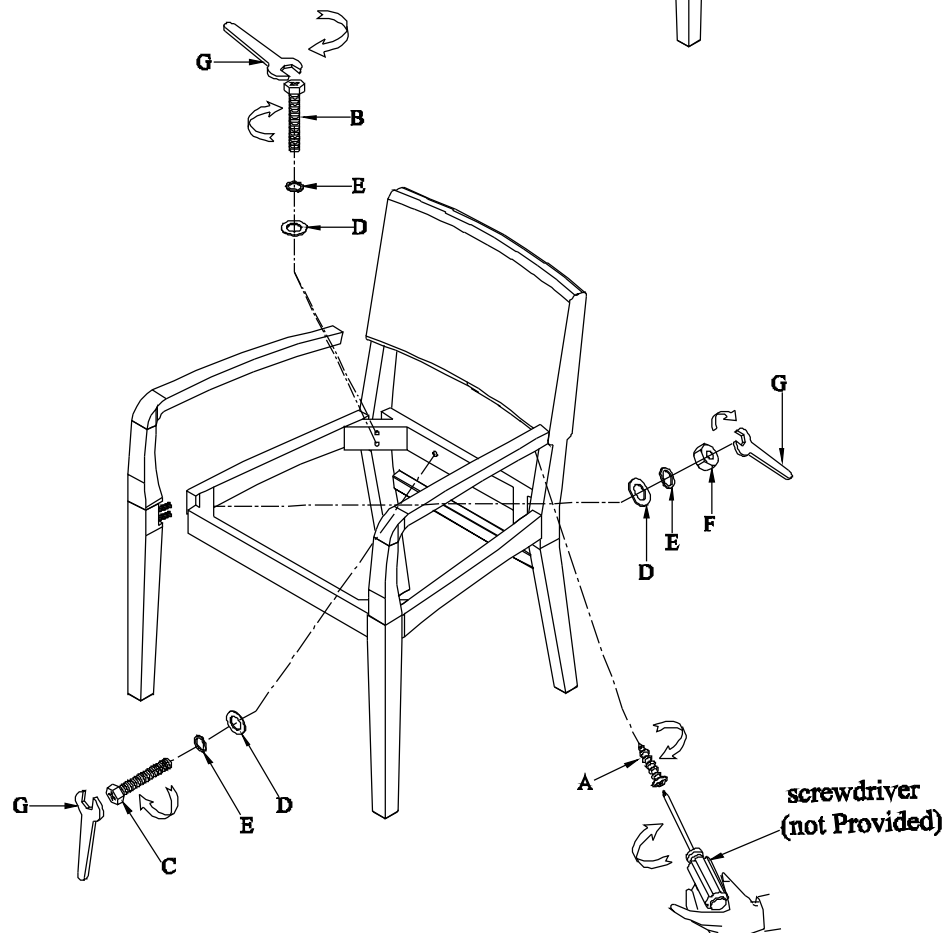
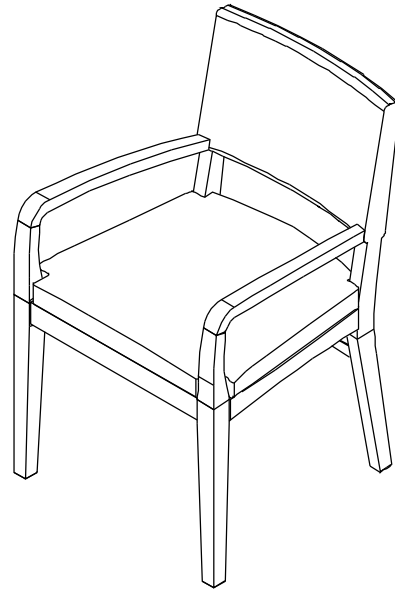

**"Before fully tightening the legs, ensure the chair is level"**