











ASSEMBLY INSTRUCTION

- ITEM# 5960-90251-MULTI Woodcreek 5/0 Mansion Headboard
 5960-90252-MULTI Woodcreek 5/0 Mansion Footboard
 5960-90267-MULTI Woodcreek 6/0-6/6 Mansion Headboard
 5960-90268-MULTI Woodcreek 6/0-6/6 Mansion Footboard
 5960-90253-MULTI Woodcreek 5/0-6/6 Rails
 5960-90263-MULTI Woodcreek 6/0 Rails

**Caution: Please make sure you have all parts indicated below prior to assembly.
 This bed is heavy and can best be assembled with the help of two or more people.**

NO.	HARDWARE LIST		Q'TY
E		NUT	8
F		SPANNER WRENCH	1
G		CURVED WASHER	8
H		FULL THREADED BOLT	8
K		SCREW	20 (for 6/6&6/0 bed) 16 (for 5/0 bed)
R		4MM ALLEN WRENCH	1
Q		BOLT	10 (for 6/6&6/0 bed) 8 (for 5/0 bed)
V		LOCK WASHER	10 (for 6/6&6/0 bed) 8 (for 5/0 bed)
U		FLAT WASHER	10 (for 6/6&6/0 bed) 8 (for 5/0 bed)
M		5MM ALLEN WRENCH	1

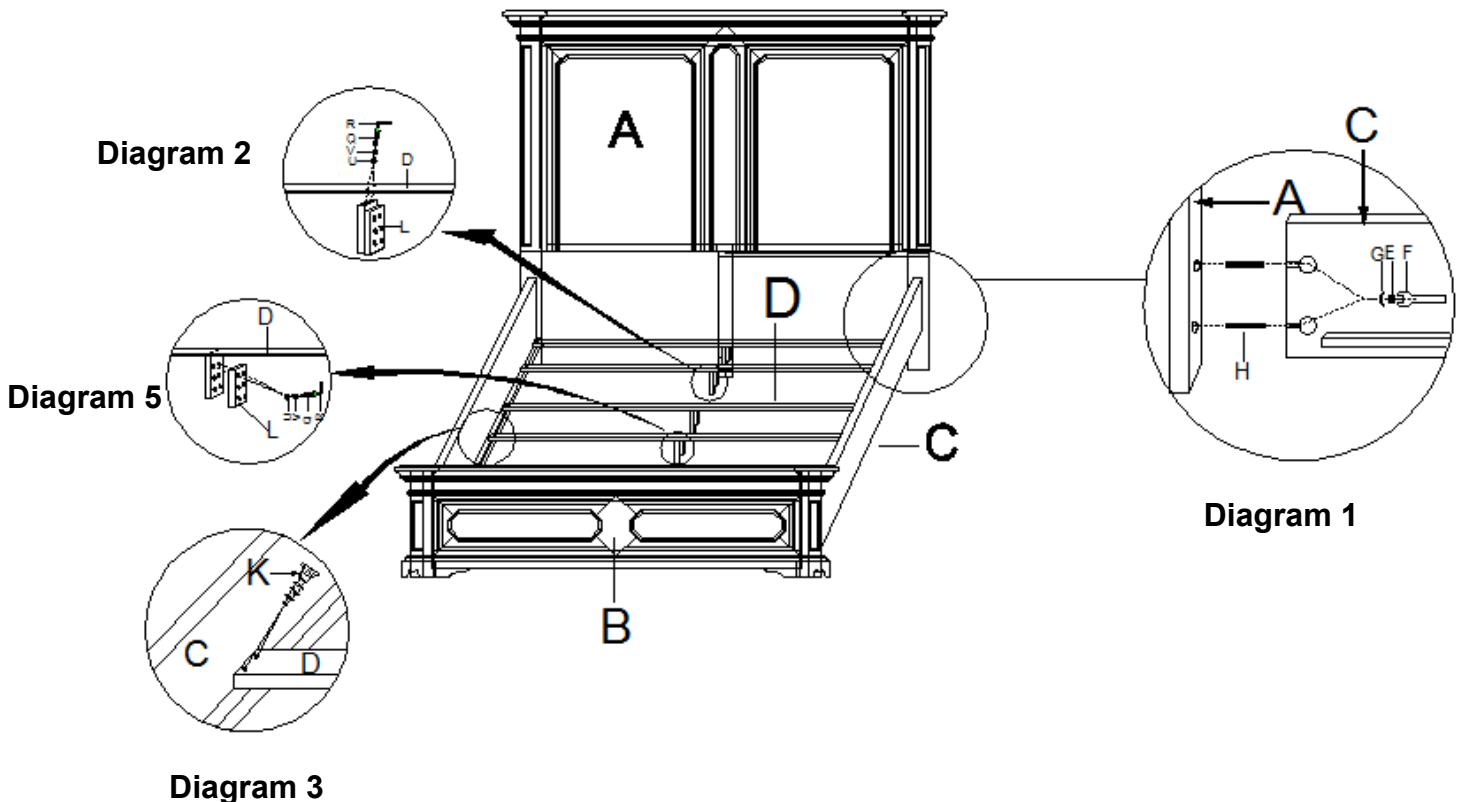
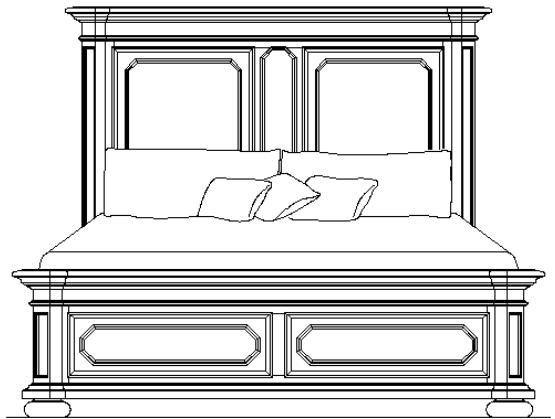

Please note the hardware bag to assemble side rails to HB&FB is in the box of side rails.

Assembly steps:

1. Insert 2 bolts (H) into holes of each side post on Headboard (A) and Footboard (B), attach the ends of side rails (C) to bolts (H) on posts by using 2 curved washers (G) and 2 nuts (E), tighten nuts (E) securely with spanner wrench (F). (See diagram 1)

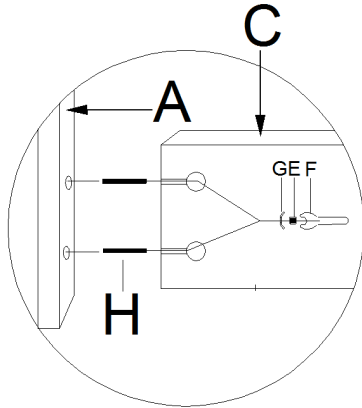

Diagram 1

2. Take out center supports (L) from the rail box, attach center supports (L) to slats (D) by using 2 bolts (Q), 2 lock washers (V) and 2 flat washers (U). Secure bolts (Q) by using allen wrench (R). (See diagram 2)

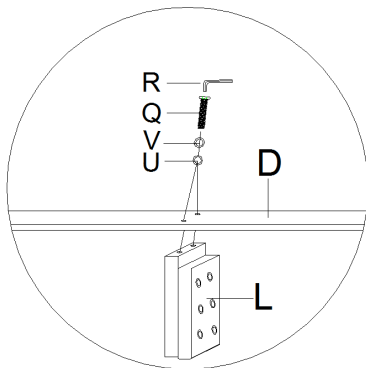

Diagram 2

3. Attach slats (D) to side rails (C), align pre-drilled holes on the slats to holes on the cleats of side rails (C), using screws (K) to tighten both. (See diagram 3)

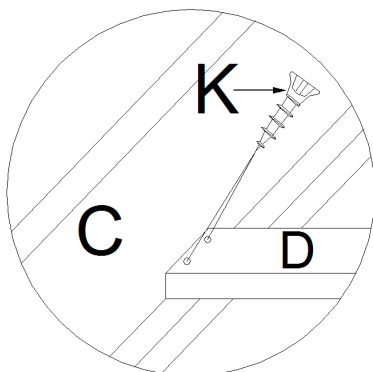

Diagram 3

Note: You can change the height of slats by adjusting the height of cleats on side rail as shown in diagram 4. Remove bolts (I), lock washers (O) and flat washers (J) from the cleats by turning the bolts (I) with allen wrench (M) in anti-clockwise direction. Adjust the cleats to a desired position, and then secure lock washers, flat washers, bolts in clockwise direction by turning with allen wrench.

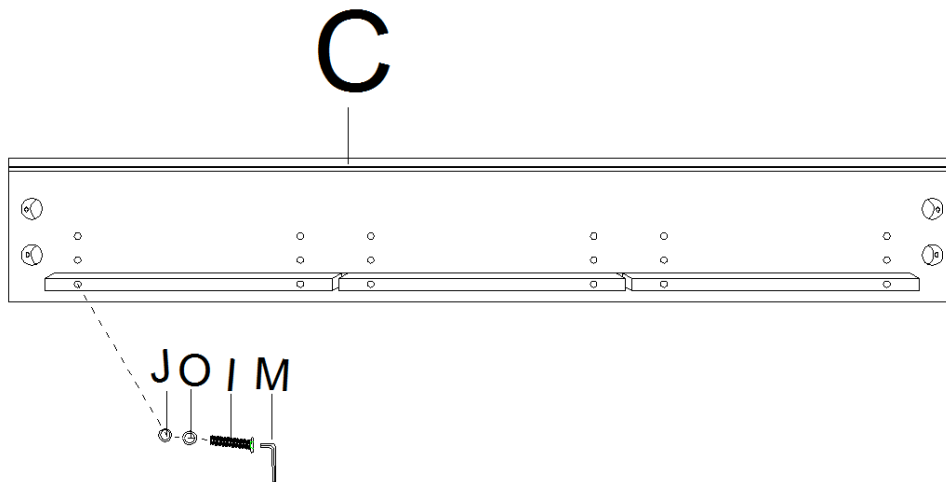

Diagram 4

You can adjust the height of center supports (L) as shown in diagram 5 to meet your need by the following steps.

1. Unscrew bolts on center supports (L) with allen wrench (R).
2. Adjust the height of center supports, align holes on 2pcs of woods and tighten them together with 2 bolts (Q), 2 lock washers (V) and 2 flat washer (U) by turning with wrench (R) in clockwise direction.

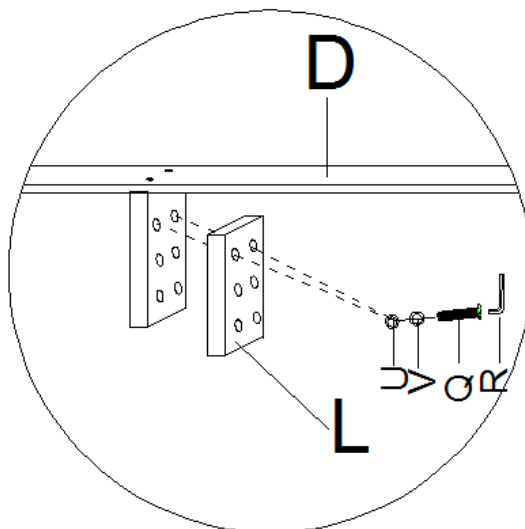

Diagram 5

Cleaning Instruction: Clean finished parts with a mild dishwashing liquid and water solution on a damp cloth. Polish the finish with soft cloth and an industry recognized furniture polish.