









ASSEMBLY INSTRUCTION

Item#: 1595-85003-LTBK Console Table

* Please make sure you have all parts indicated below prior to assembly.
This unit is heavy and can best be assembled with the help of two or more persons.

NO	HARDWARE LIST		Q'TY
A		5/16 Flat Washer	8
B		5/16 Lock Washer	8
C		5/16*25mm Bolt	8
D		73*29*5mm	1
E		1/4 Flat Washer	4
F		1/4 Lock Washer	4
G		1/4*19mm Bolt	4
H		69*27.2*4mm	1

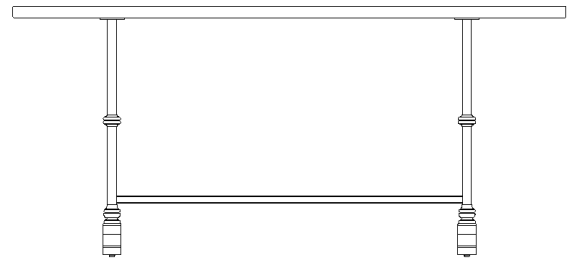

Diagram 1

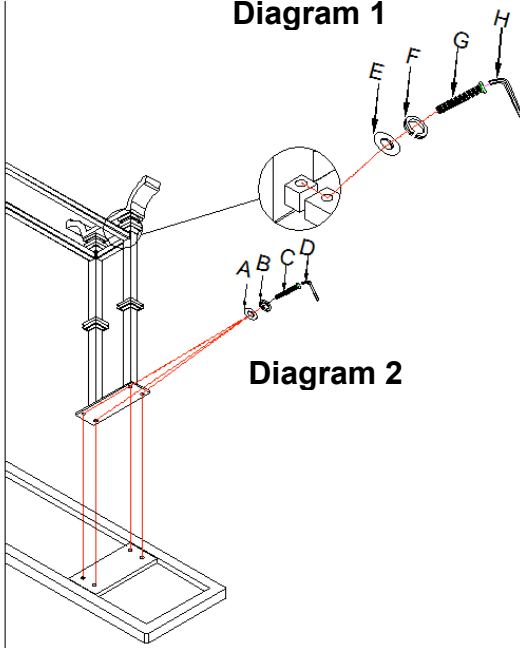

Diagram 2

Assembly Steps:

1. Place table top upside down on a soft surface to prevent from scratching.
2. Attach stretchers to legs by using flat washers (E), lock washers (F), bolts (G), secure by turning with Allen Wrench (H) in a clockwise direction. (See diagram 1)
3. Attach legs to the top by using flat washers (A), lock washers (B), bolts (C), secure by turning with Allen Wrench (D) in a clockwise direction. (See diagram 2)
4. Turn table upright.

Cleaning Instruction: Clean finished parts with a damp cloth using a mild dishwashing liquid and water solution.
Polish the finish with soft cloth and an industry recognized furniture polish.