









## ASSEMBLY INSTRUCTION

Item: 5381-90867 Upholstered Bed Headboard 6/6-6/0  
 5381-90868 Upholstered Bed Footboard 6/6-6/0  
 5381-90853 Upholstered Bed side rail 5/0-6/6  
 5381-90863 Optional Uph Side rail 6/0

Thank you for purchasing this quality product. Be sure to unpack carefully looking for small parts which may have come loose during shipment.

Read all instruction and study the drawing carefully before starting the assembly process.

HARDWARE LIST OF HEADBOARD - 90867				
NO.	DESCRIPTION	SIZE	DRAWING	Q'TY
A	HEXAGONAL BOLT	Ø5/16"*1-3/4"		8PCS
B	LOCK WASHER	Ø5/16"		8PCS
C	FLAT WASHER	Ø5/16"*19MM		8PCS
D	OPEN WRENCH	Ø5/16"		1PC

HARDWARE LIST OF BED RAILS - 90853 / 90863				
NO.	DESCRIPTION	SIZE	DRAWING	Q'TY
H	THREADED BOLTS	Ø5/16"*4"		8PCS
I	HEXAGONAL NUT	Ø5/16"		8PCS
J	CURVED WASHER	Ø5/16"		8PCS
K	OPEN WRENCH	Ø5/16"		1PC

HARDWARE LIST OF FOOTBOARD - 90868				
NO.	DESCRIPTION	SIZE	DRAWING	Q'TY
L	SCREW	8*1-1/4"		10PCS

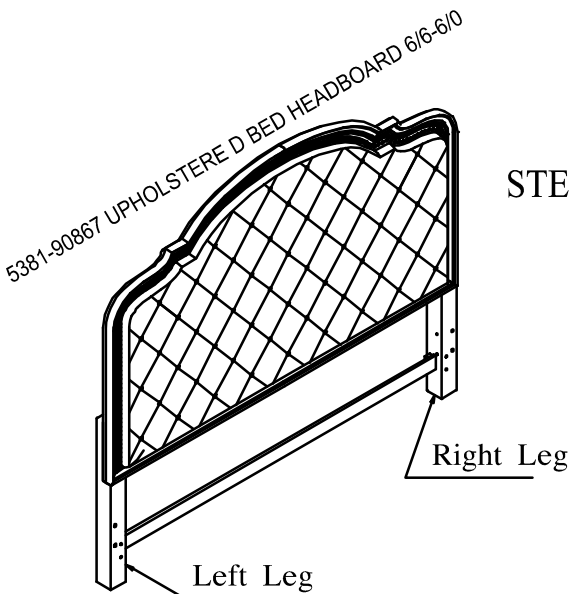

**STEP 1:** Attach legs to headboard using hexagonal bolts(A), lock washer(B), flat washer(C), and attach bottom rail to the legs using hexagonal bolt (A) as show in step 1. Using an open wrench (D) to tighten all the Bolts.

### STEP 1

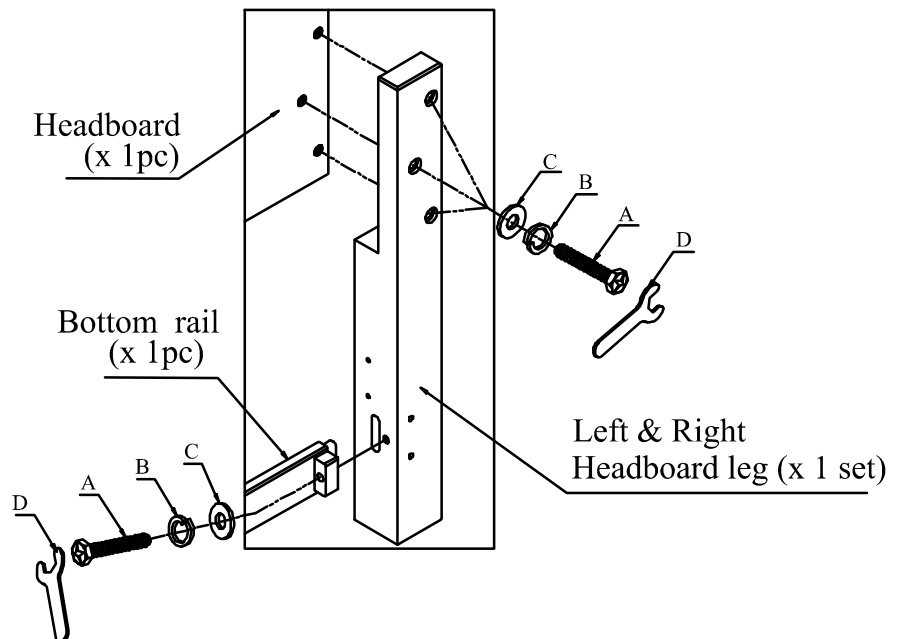

# ASSEMBLY INSTRUCTION

- Item: 5381-90867 Upholstered Bed Headboard 6/6-6/0  
 5381-90868 Upholstered Bed Footboard 6/6-6/0  
 5381-90853 Upholstered Bed side rail 5/0-6/6  
 5381-90863 Optional Uph Side rail 6/0

Thank you for purchasing this quality product. Be sure to unpack carefully looking for small parts which may have come loose during shipment.

Read all instruction and study the drawing carefully before starting the assembly process.

