

Family: Quebec | Item No. 1295 IB

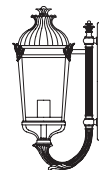

▼ start here

Drawing 1 - Strap Detail

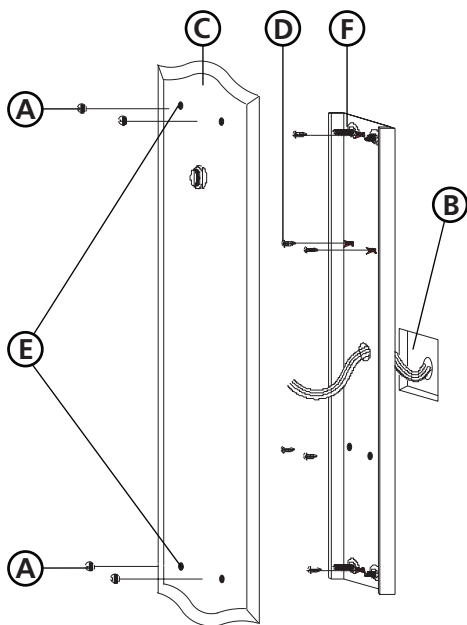

1

1. Find a clear area in which you can work.
2. Unpack fixture and glass from carton.
3. Carefully review instructions prior to assembly.

***** The construction of this fixture will be accomplished by first installing the mounting strap, assembling the fixture, making all necessary electrical connections, mounting the fixture, and then installing the glass.**

2

1. Remove ball knobs (A) from fixture and remove retainer plate (C) - see **Drawing 1**.
2. Slip wire from junction box (B) through the 9/16" dia. access hole in the retainer plate (C).
3. Remove appropriate knock outs from the star pattern on the retainer plate (C) that match the mounting hole location on your junction box.
4. Mount retainer plate (C) to the junction box (B) using the screws provided.
5. The top and bottom ends of the retainer plate have additional attachments points that can be used. To attach the plate at these points use the wood screws (D) provided.

SAFETY WARNING: READ WIRING AND GROUNDING INSTRUCTIONS (I.S. 18) AND ANY ADDITIONAL DIRECTIONS. TURN POWER SUPPLY OFF DURING INSTALLATION. IF NEW WIRING IS REQUIRED, CONSULT A QUALIFIED ELECTRICIAN OR LOCAL AUTHORITIES FOR CODE REQUIREMENTS.

Drawing 2 - Glass Installation

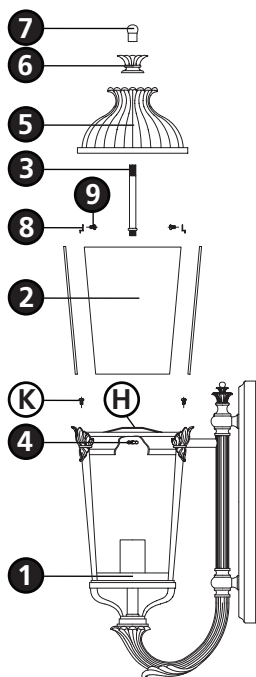

3

1. Make electrical connections from supply wire to fixture lead wires. Refer to instruction sheet (I.S. 18) and follow all instructions to make all necessary wiring connections. Then refer back to this sheet to continue installation.

4

1. Mount the fixture to the wall by slipping holes (E) in backplate (C), over screws (F) in retainer plate - see **Drawing 1**.
2. Fixture can now be lamped accordingly.

5

1. To install glass, remove cross bar (H) by removing screws (K) with a Phillips screw driver - see **Drawing 2**.
2. Remove glass clips (8) from inside cage assembly (1) by removing screw (9) with a Phillips screwdriver.
3. Slip glass panels (2) into cage assembly (1).
4. Replace glass clips (8) and screws (9).
5. Slip center stem (3) into center hole of bracket (H) removed earlier and secure it with hex nut (4).
6. Fixture can now be lamped accordingly.
7. To assemble fixture, slip roof (5) onto center stem (3) and down onto cage assembly (1).
8. Slip break (6) onto center stem (3).
9. Thread knob (7) onto end of center stem (3) to secure roof.

Note: Maximum wattage for 1295 fixture is 100 watts per bulb.

2.7.08