

Family: Element | Item No. 5223 BN

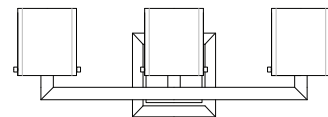

**Drawing 1 - Fixture Mounting**

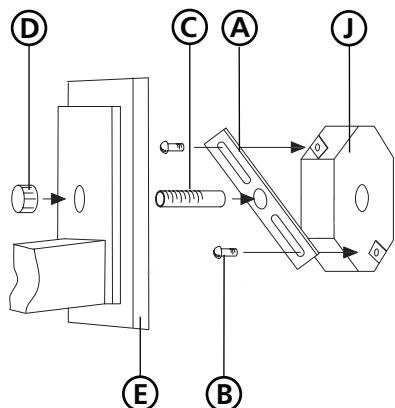

**Drawing 2 - Glass Installation**

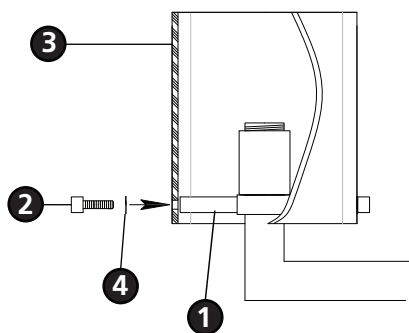

## ▼ start here

**1**

1. Find a clear area in which you can work.
2. Unpack fixture and glass from carton.
3. Carefully review instructions prior to assembly.

**\*\*\* The construction of this fixture will be accomplished by first mounting the mounting strap to the junction box, making all necessary electrical connections, mounting the fixture to the wall, and then installing the fixture glass.**

**2**

1. Prepare mounting strap (A) by threading 1-5/8" nipple into the center hole of the mounting strap (A), approximately 1/4" - see **Drawing 1**.
2. Attach mounting strap (A) to junction box (J) using two 1" screws (C) provided.

**SAFETY WARNING: READ WIRING AND GROUNDING INSTRUCTIONS (I.S. 18) AND ANY ADDITIONAL DIRECTIONS. TURN POWER SUPPLY OFF DURING INSTALLATION. IF NEW WIRING IS REQUIRED, CONSULT A QUALIFIED ELECTRICIAN OR LOCAL AUTHORITIES FOR CODE REQUIREMENTS.**

**3**

Make electrical connections from supply wire to fixture lead wires. Refer to instruction sheet (I.S. 18) and follow all instructions to make all necessary wiring connections. Then refer back to this sheet to continue installation of this fixture.

**4**

1. To mount fixture, slip center hole of backplate (E) over nipple (C) and hold fixture in position - see **Drawing 1**.
2. Thread decorative knob (D) onto end of nipple (C) and tighten to secure fixture.

**5**

1. Install the glass by first slipping glass (3) around cross bars (1) and lining up the holes in the glass (3) with the holes in the end of the cross bars (1) - see **Drawing 2**.
2. Slip ball knob stud (2) through plastic washer (4) and hole in glass (3) and thread it into end of cross bar (1).
3. Repeat step 1 and 2 to attach glass onto the remaining light fixtures.
4. Fixture can now be lamped accordingly.

Note: Maximum wattage for 5223 fixture is 60 watts G-9 per bulb.

10.28.10