

Family: Duet | Item No. 5612/5613/5614/5615

▼ start here

Drawing 1 – Mounting

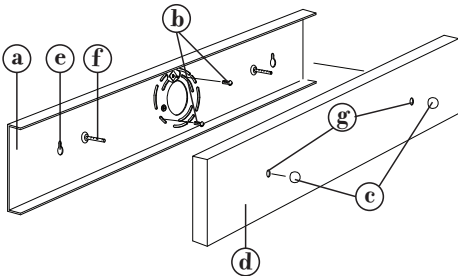

1

1. Find a clear area in which you can work.
2. Unpack fixture and glass from carton.
3. Carefully review instructions prior to assembly.

*** The construction on this fixture will be accomplished by first mounting the mounting strap to the junction box, making all necessary electrical connections, assembling the main body of the fixture, mounting the fixture to the wall, and then installing the glass.

Drawing 2 - Bulb shield installation

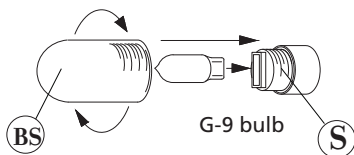

2

1. Remove ball knobs (c) from front of backplate (d)- see Drawing 1.
2. Remove retainer plate (a) from backplate (d).
3. Attach retainer plate (a) to junction box using two 8-32 screws (b).
4. Additional screws can be installed at points (e) for additional mounting support. Please use appropriate anchors.

Drawing 3 - Glass installation

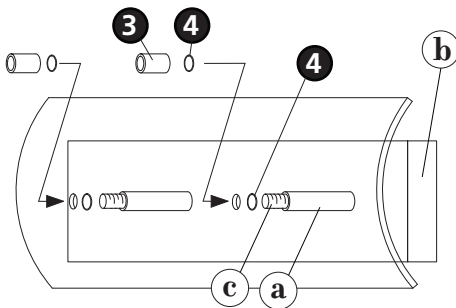

3

SAFETY WARNING: READ WIRING AND GROUNDING INSTRUCTIONS (I.S. 18) AND ANY ADDITIONAL DIRECTIONS. TURN POWER SUPPLY OFF DURING INSTALLATION. IF NEW WIRING IS REQUIRED, CONSULT A QUALIFIED ELECTRICIAN OR LOCAL AUTHORITIES FOR CODE REQUIREMENTS.

Make electrical connections from supply wire to fixture lead wires. Refer to instruction sheet **(I.S. 18)** and follow all instructions to make all necessary wiring connections. Then refer back to this sheet to continue installation of this fixture.

4

1. Mount the fixture by selecting the back plate **(B)** over mounting plate **(A)** - see **Drawing 1**.
2. Attach the back plate **(B)** to the mounting plate **(A)** using the screws **(C)**.

5

1. Fixture can be lamped accordingly prior to glass installation. First slip G-9 bulbs provided into socket.
2. Then thread bulb shield (BS) onto socket (S).

6

1. To install glass first remove decorative cap (1), threaded tube (2), spacer (3), and plastic washers (4) from arm (A) that extends from backplate (B) - see **Drawing 3**.
2. First slip a plastic washer onto each of the threaded tubes (c), now slip glass (5) [large piece] onto threaded tubes (C), followed by plastic washers (4).
3. Thread spacer (3) onto threaded tube (C) and hand tighten only, now thread threaded tube (2) into end of spacer (3) - see **Drawings 3 and 4**
4. Now slip a plastic washer onto threaded tube (2), then slip glass (6) [small piece] onto threaded tubes (2) - see **Drawing 45**. Slip a plastic washer (4) onto threaded tubes (2), then thread decorative

Drawing 4 - Glass installation

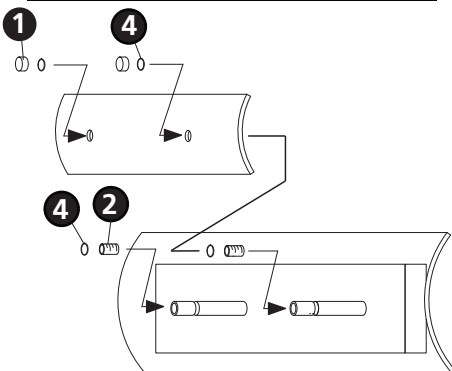

Drawing 1 - Flush Mount

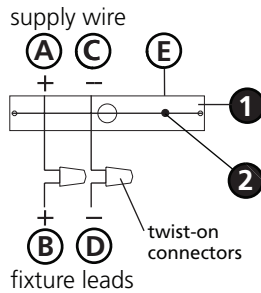

Drawing 2 - Chain Hung

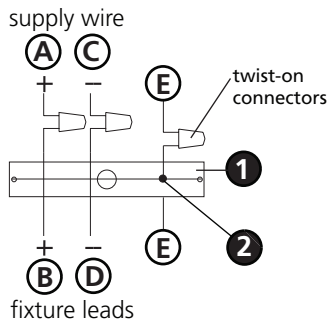

Drawing 3 - Post-Mount

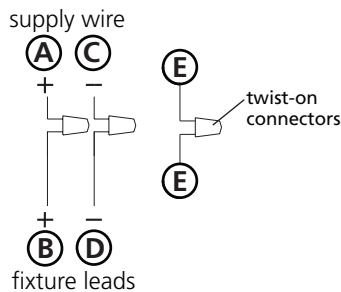

SAFETY WARNING: READ WIRING AND GROUNDING INSTRUCTIONS (I.S. 18) AND ANY ADDITIONAL DIRECTIONS. TURN POWER SUPPLY OFF DURING INSTALLATION. IF NEW WIRING IS REQUIRED, CONSULT A QUALIFIED ELECTRICIAN OR LOCAL AUTHORITIES FOR CODE REQUIREMENTS.

wiring instructions

Indoor Fixtures

1. Connect positive supply wire **(A)** (typically black or the smooth, unmarked side of the two-conductor cord) to positive fixture lead **(B)** with appropriately sized twist on connector - see **Drawings 1 or 2**.
2. Connect negative supply wire **(C)** (typically white or the ribbed, marked side of the two-conductor cord) to negative fixture lead **(D)**.
3. Please refer to the **grounding instructions** below to complete all electrical connections.

Outdoor Fixtures

1. Connect positive supply wire **(A)** (typically black or the smooth unmarked side of the two-conductor cord) to positive fixture lead **(B)** with appropriately sized twist on connector - see **Drawings 2 or 3**.
2. Connect negative supply wire **(C)** (typically white or the ribbed, marked side of the two-conductor cord) to negative fixture lead **(D)**.
3. Cover open end of connectors with silicone sealant to form a watertight seal.
 - If installing a wall mount fixture, use caulk to seal gaps between the fixture mounting plate (backplate) and the wall. This will help prevent water from entering the outlet box. If the wall surface is lap siding, use caulk and a fixture mounting platform specially.
4. Please refer to the **grounding instructions** below to complete all electrical connections.

grounding instructions

Flush Mount Fixtures

For positive grounding in a 3-wire electrical system, fasten the fixture ground wire **(E)** (typically copper or green plastic coated) to the fixture mounting strap **(1)** with the ground screw **(2)** - see **Drawing 1**.

Note: On straps for screw supported fixtures, first install the two mounting screws in strap. Any remaining tapped hole may be used for the ground screw.

Chain Hung Fixtures

Loop fixture ground wire **(E)** (typically copper or green plastic coated) under the head of the ground screw **(2)** on fixture mounting strap **(1)** and connect to the loose end of the fixture ground wire directly to the ground wire of the building system with appropriately sized twist-on connectors - see **Drawing 2**.

Post-Mount Fixtures

Connect fixture ground wire **(E)** (typically copper or green plastic coated) to power supply ground with appropriately sized twist-on connector inside post. Cover open end of connector with silicone sealant to form a watertight seal - see **Drawing 3**.