

Tips for a Successful Installation

Selkirk's Saf-T Vent systems are Special Gas Vent systems designed to meet the unique venting challenges presented by positive-pressure, condensing gas-fired appliances.

Saf-T Vent systems have been successfully installed in thousands of residential, commercial and industrial settings with a track record of superior performance dating back nearly 20 years.

As part of our effort to continuously improve the products we manufacture, Selkirk has performed extensive testing, visited job site installations and listened to countless installers. The information we have gathered has prompted us to write this bulletin which highlights important installation practices that lead to gas-tight, leak-proof, properly installed systems.

Key Points

1. Read & follow the appliance manufacturer's instructions.
2. Read & follow Selkirk's instructions.
3. When RTV Sealant is required, apply it correctly.
4. Secure the joint!
5. Get going in the right direction – Follow the flow arrows.
6. Maintain proper slope – Install with a continuous $\frac{1}{4}$ " per foot (minimum) slope back to the appliance.
7. Drain the condensate.
8. Provide adequate support – Support after every offset or elbow, after every 6 feet of horizontal run, after every 30 feet of vertical run, and at each adjustable fitting.
9. Inspect annually.

1. Read & Follow the Appliance Manufacturer's Instructions.

- Manufacturers develop and test their appliances to operate efficiently and safely when vented properly. Many appliance installation manuals will give instructions on the maximum number of offsets or elbows as well as the total equivalent length of vent allowed. Always refer to the manufacturer's manuals for guidance.
- Common venting of appliances is permitted only when allowed by the appliance manufacturer(s).
- Some appliances must be vented with double-wall Saf-T Vent CI Plus. If the manual does not distinguish between single-wall and double-wall, call us for a recommendation.
- Manufacturer's instructions supercede Heatfab manuals.
- Clearance requirements outlined in the appliance manufacturer's manuals must be followed. Their clearances and/or national and local code requirements take priority over Heatfab instructions.

2. Read & Follow Selkirk's Instructions.

- Installation and Maintenance Instructions for Saf-T Vent systems are packaged with critical components (elbows, tees, and terminations), as are other supplemental instruction sheets for the critical component itself.
- Accessories (roof jacks, vertical supports, and wall penetrations) come with detailed instructions specific to their proper installation.
- If you have questions on correct installation methods, call us. Our engineering technicians would love to hear from you.
- Installation information is also available at our web site www.heatfab.com.
- BEFORE YOU TRY IT YOUR WAY, PLEASE TRY OUR WAY FIRST!

3. When RTV Sealant is Required, Apply It Correctly.

- Sealant MUST be used on diameters larger than 16 inches! Diameters 5" – 16" have an integral gasket built right in. RTV Sealant is NOT required for these diameters.
- Use only GE RTV 106 or Dow Corning 732.
- GE RTV 106 will cover all Heat-fab installations with flue gas temperatures up to 550°F.
- Dow Corning 732 may be used on low temperature applications with flue gas temperatures up to 300°F.
- Clean the joint area before applying sealant. Alcohol pads are included with each part and should be used to remove dirt and trace oils.
- A 1/8" bead of sealant is enough.
- Apply the sealant on the outside of the male end (end without tabs), about 1/4" – 3/8" up from the end of the part, in a straight and continuous bead. A straight and continuous bead works just fine – a zigzag or wavy line usually applies too much sealant and could leave gaps. Gaps in the bead will cause leaks.
- Inspect the joint after it has been put in place. Apply extra sealant to any voids or crevices. Smooth it out with your finger if you want – but wipe the excess on a paper towel or work rag, not on your clothes. RTV will stain and is difficult to remove.
- Be sure to apply extra sealant when called for. Some joints, such as adjustable sections and flue collar connections, require additional sealant.
- GIVE IT A REST! Dow Corning and GE both recommend sealant be allowed to cure for 24 hours before operating the appliance.

4. Secure the Joint

- Insert the tapered male end into the flared female end using enough pressure to completely seat the connection.
- DO NOT attempt to make up inches by joining the sections partially.
- For parts with the Ring-and-Tab connection, slide the Ring over all Tabs, bringing it down as far as possible. Now bend the Tabs over completely. A flat head screwdriver can be helpful to start bending the Tabs.
- For CI Plus parts:
 - Insert the male end into the female end, lining up the Locking Tabs at the same time. If needed, use pliers to squeeze the Tabs so they will accept the slots in the Mechanical Locking Strap. Spraying the gasket with water or a mixture of water and liquid soap will lubricate it for an easier assembly.

- When assembling elbows and tees, the male end tabs will rotate around the vent to accommodate offsets and direction changes.
- Position the Mechanical Locking Strap over the Tabs, making sure each slot encompasses both Tabs, and then tighten.
- Center the Coupler Band around the completed joint and tighten.
- DO NOT use screws or pop rivets when joining Saf-T Vent systems! EXCEPTION: Saf-T Vent SC is designed to be assembled with the use of tap screws, which are included with each part.

5. Get Going in the Right Direction – Follow the Flow Arrows.

- Every length of Heatfab vent has a product sticker with an arrow showing the direction of flue gas flow.
- The tapered ends of the Saf-T Vent parts are designed to help drain condensate back to the appliance. Although the direction of the tapered ends will seem backward for smooth airflow, don't worry. It's more important to remove the condensate from the system.
- Line-up the seams – makes a good-looking job!
- Turn the seams up towards the ceiling when installing horizontally.

6. Maintain Proper Slope.

- Install with a continuous ¼" per foot (minimum) slope, as is required by the National Fuel Gas Code for all gas-fired appliances.
- Vent systems for condensing appliances must have a continuous ¼" per foot (minimum) slope toward the appliance or a condensate drain. Always check the appliance manufacturer's instructions for proper drain requirements.
- Some appliances require the venting system to be sloped toward the **horizontal termination**.
- Remember, if you raise the appliance or lower the ceiling you must adjust the slope of the vent to maintain the ¼" per foot minimum.
- Use the chart below to help plan your system.

| Horizontal Length | Flue Pitch |
|-------------------|------------|
| 1 foot | ¼ inch |
| 2 feet | ½ inch |
| 3 feet | ¾ inch |
| 4 feet | 1 inch |
| 5 feet | 1 ¼ inches |
| 6 feet* | 1 ½ inches |
| 7 feet | 1 ¾ inches |
| 8 feet | 2 inches |
| 9 feet | 2 ¼ inches |
| 10 feet | 2 ½ inches |

| Horizontal Length | Flue Pitch |
|-------------------|------------|
| 11 feet | 2 ¾ inches |
| 12 feet* | 3 inches |
| 13 feet | 3 ¼ inches |
| 14 feet | 3 ½ inches |
| 15 feet | 3 ¾ inches |
| 16 feet | 4 inches |
| 17 feet | 4 ¼ inches |
| 18 feet* | 4 ½ inches |
| 19 feet | 4 ¾ inches |
| 20 feet | 5 inches |

| Horizontal Length | Flue Pitch |
|-------------------|------------|
| 21 feet | 5 ¼ inches |
| 22 feet | 5 ½ inches |
| 23 feet | 5 ¾ inches |
| 24 feet* | 6 inches |
| 25 feet | 6 ¼ inches |
| 26 feet | 6 ½ inches |
| 27 feet | 6 ¾ inches |
| 28 feet | 7 inches |
| 29 feet | 7 ¼ inches |
| 30 feet*† | 7 ½ inches |

* A Horizontal Support is required every six feet and after every elbow or offset.

† A Condensate Drain is required every 30 feet.

7. Drain the Condensate.

- Follow the appliance manufacturer's installation instructions. Some require condensate drains only for vent systems over a certain length.
- If a drain is required, Selkirk recommends:
 - Drains at all transitions from horizontal to vertical vent runs.
 - Immediately before a horizontal termination.
 - After every 30 feet of continuous vent.
 - The first drain should be as close to the appliance flue collar as possible. Some appliances have internal drains or drains built into their vent adapter.
 - Avoid installing drains outdoors in cold climates. When transitioning from horizontal to vertical up the outside of a building, use an elbow instead of a boot tee. Locate a drain fitting inside the building as close to the elbow as possible. This will prevent freeze ups.
- Always connect the drain to a sanitary sewer or other approved disposal.
- Install a trap in the drain.
- Use the Drain Hose Kit – It connects easily and can also be used as a drain trap when looped. It is available in 5- and 10-foot lengths.

8. Provide Adequate Support.

- On horizontal runs support the vent system every 6 feet and after each elbow or offset. Adjustable sections should be supported as well.
- On vertical installations support is required at minimum after every 30 feet of vertical rise, at each floor penetration, and at the roof penetration. For large diameter systems (12 inch and larger), most installers find it easier to use more support brackets to support the system during installation.
- Support should be provided at the first section above a boot tee that is installed at the base of a vertical stack.
- To support long vertical runs inside a chase or chimney, use either guy wire supports or vertical supports. Guy wire supports work best for tight or inaccessible stacks, but require a set of guy wires for each support. Vertical supports are mounted directly to the inside wall of the chase or chimney.
- Heat-fab guy wire supports are necessary when the vent system extends above the roofline six feet or more.
- Use Heat-fab support brackets or strapping. Our support clamps can be used with threaded rod either singly (as a saddle) or in pairs.
- When using clamping-style supports, do not over-tighten to the point that the vent is damaged or deformed.
- Some installers prefer to hang perforated channel iron to form a trapeze and rest the vent on top of it.
- Consider the behavior of the appliance when planning your supports. Some appliances create pulsing vibrations in their vent systems. Avoid attaching the supports to structural components that may transmit vibrations to occupied spaces. Be sure the support fasteners (nuts, bolts, etc.) cannot vibrate loose.

9. Inspect Annually.

- During your annual HVAC equipment and system check, inspect the vent system. Make sure the system has not been damaged, the vent has not been punctured and the supports are solid.
- Look for the proper slope toward a drain. Make sure drains are not clogged or pinched off, and are in the proper place. Verify that all drain traps are properly primed.
- Inspect the termination and remove any accumulated debris.
- Properly installed and maintained, Selkirk Vent Systems will be trouble free for years.

Your Check List

- You have read the Appliance Manufacturer's installation instructions.
- You have read Selkirk's installation manual.
- You properly applied the correct RTV sealant, if required.
- All vent system joints are tight and secure.
- The vent system is installed with flow arrows pointing away from the appliance.
- Proper slope has been maintained.
- You have made provisions for the system to drain – when necessary.
- The vent system is supported adequately.
- You have explained the vent system to the building maintenance personnel.

This document is designed as a summary of issues to be aware of when using Selkirk's Saf-T Vent systems. It is not intended to take the place of the complete installation manuals that should be reviewed and followed closely.

Further information, including complete installation manuals, is available by calling 800.772.0739. Or log onto our Internet site at: www.heatfab.com.

Connecting Saf-T Vent® EZ Seal to Appliances and Other Saf-T Vent Products

EZ Seal IS Compatible with Existing Heat-fab Products. Here's how:

1. Connecting to an Appliance Flue Collar

- If the flue collar that comes with the appliance has Heat-fab's integral red seal, you may attach EZ Seal pipe and fittings directly to it. Make the joint as described in the EZ Seal installation instructions (Pub # PI-EZ).

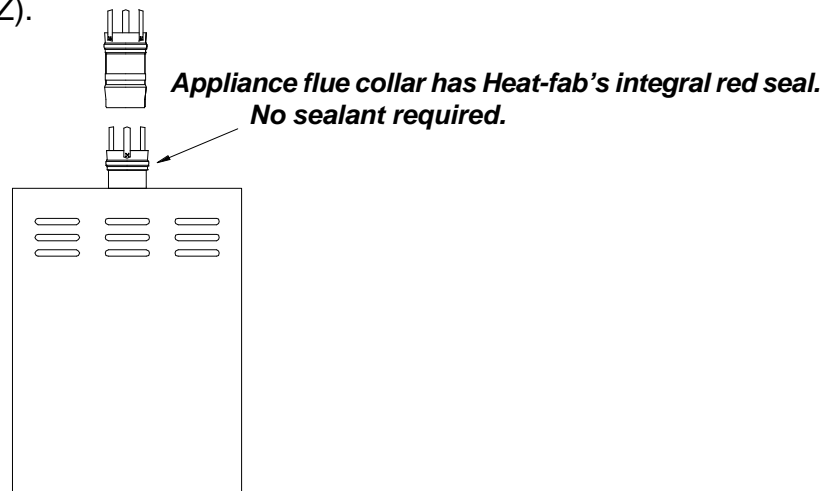
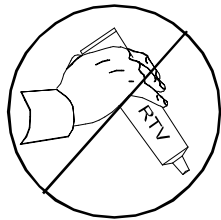

- If the flue collar has Heat-fab's female end (with the 3 tabs) but does not have the integral red seal, you will need to use an approved high-temperature RTV silicone sealant to make the joint between the flue collar and the first piece of EZ Seal. The rest of the system can be sealant-free if it is all EZ Seal.

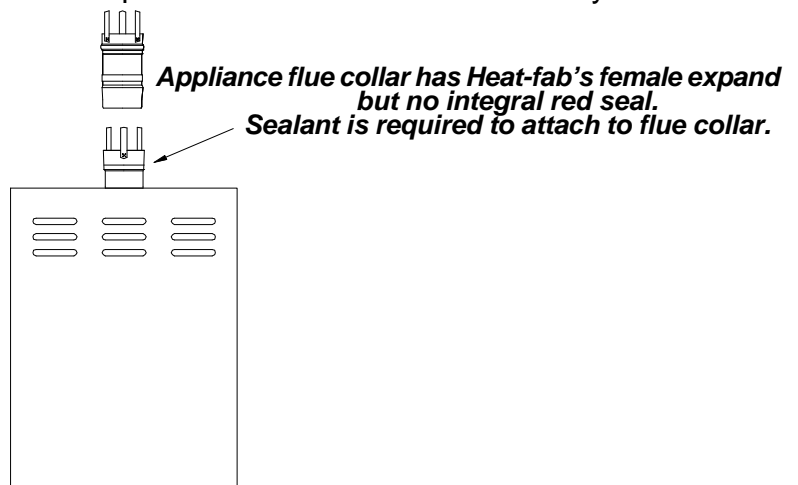
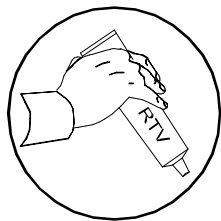

2. Connecting an EZ Seal Appliance Adapter to the Appliance

- If the EZ Seal appliance adapter has been designed for a sealant-free connection to the appliance, it will have an integral red seal in the female end and in the end that attaches to the appliance.

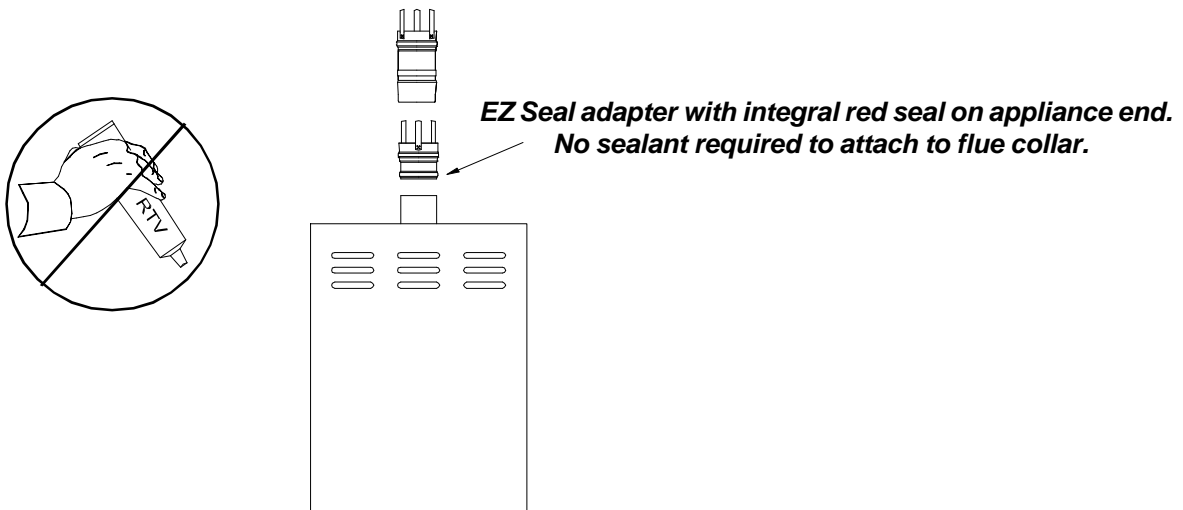

- If the integral red seal is only in the female end, you will need to use an approved high-temperature RTV silicone sealant to make the connection to the appliance. Follow the procedure recommended by the appliance manufacturer.

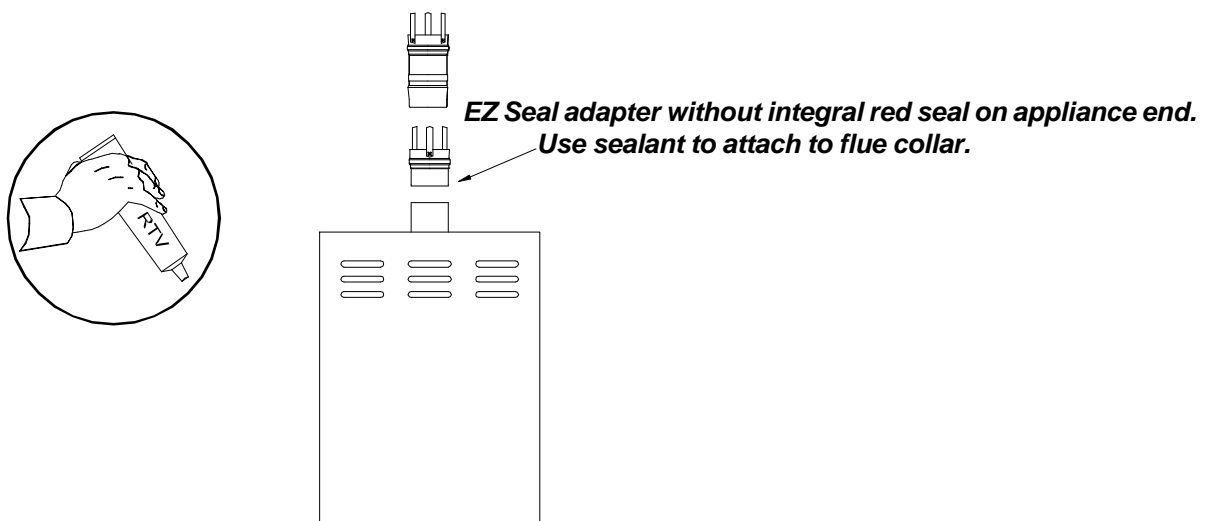

3. Connecting EZ Seal to Saf-T Vent GC (single-wall) or Saf-T Vent CI (double-wall)

- Saf-T Vent GC and Saf-T Vent CI lack the integral red seal. When you connect EZ Seal to them you will need to use an approved high-temperature RTV silicone sealant. Follow the procedure outlined in the GC or CI installation instructions (Pub # PI-VBH or PI-CIINS).

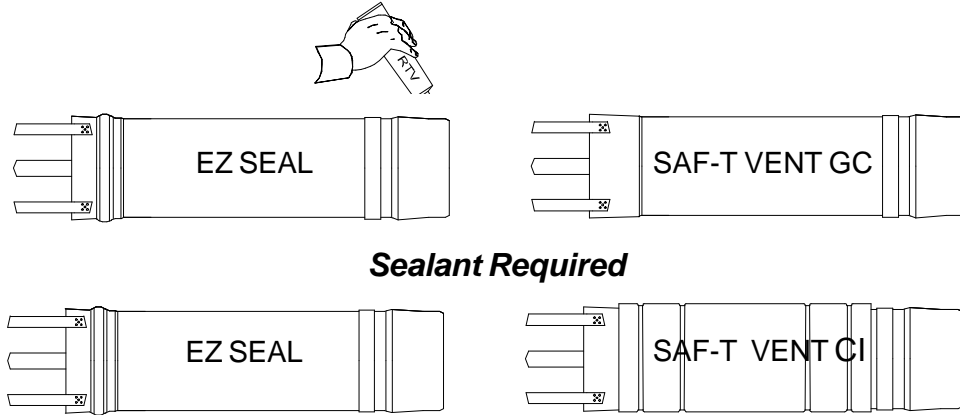

4. Attaching Saf-T Vent Terminations to EZ Seal

- Existing Saf-T Vent Terminations (rain cap, screen termination, elbow termination, tee termination, mitered termination, and others) can be used with the EZ Seal system. Simply insert the termination into the female end of the last section of EZ Seal, and then make the ring-and-tab connection as you normally would.

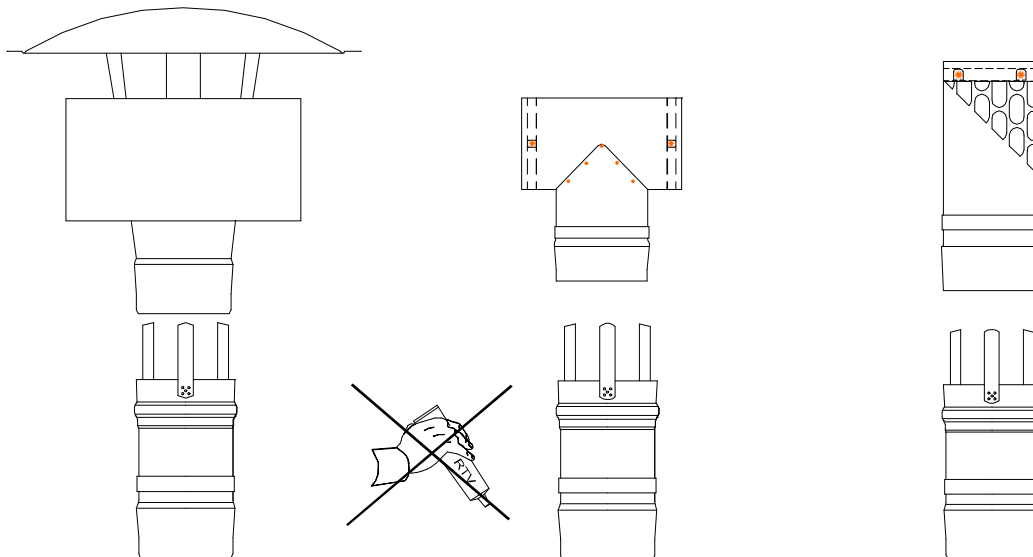

Termination attaching to EZ Seal, NO sealant required.

5. Connecting Saf-T Vent GC or Saf-T Vent CI to EZ Seal

- Saf-T Vent GC and Saf-T Vent CI sections and fittings may be attached to an EZ Seal system:
- If the male end (without tabs) of the GC or CI part was made with a butt-weld (a single layer of steel at the weld area), the part can be attached to an EZ Seal female end without using sealant.
- If the male end was made with an overlapped weld (two layers of steel at the weld area), the joint must be made using an approved high-temperature RTV silicone sealant. Follow the procedure outlined in the GC or CI installation instructions (Pub # PI-VBH or PI-CIINS).

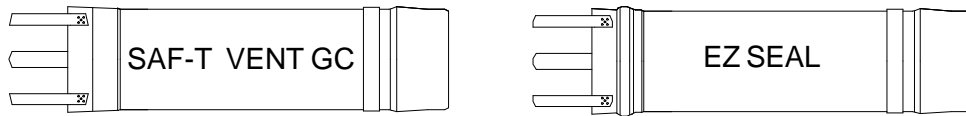

Use of Sealant Depends on the Type of Weld

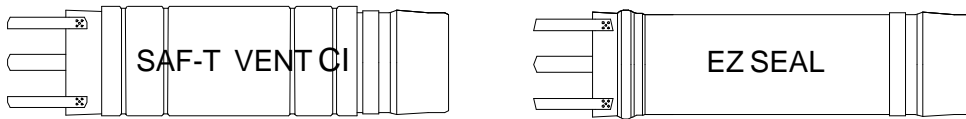

End View of a Saf-T Vent GC or CI Section or Fitting

**Butt Weld
Single Layer of Steel**

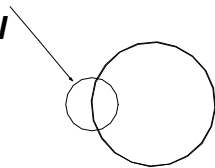

**Overlap Weld
Two Layers of Steel**

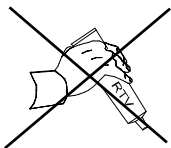
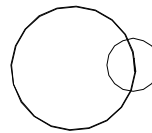

No Sealant required

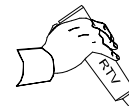
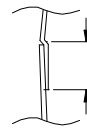
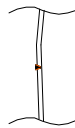

Sealant required

**Detailed Installation Instructions for
Saf-T CI Vent and Saf-T Vent Guy Sections**

The Saf-T Vent and Saf-T CI Vent Guy Sections may be utilized for additional support as system support hangers (when the systems are installed in long inaccessible chases) or for guy attachment sections for additional wind load resistance at extended heights above a roof.

Installation Inside A Chase

When the Saf-T Vent or Saf-T CI Vent must extend inside an inaccessible chase (or pre-existing chimney) for distances beyond the recommended maximum between supports (80 feet for Saf-T Vent 3 - 8" dia, 50 feet for Saf-T Vent 10" or larger, and 60 feet for Saf-T CI Vent) the Guy Sections may be used to anchor the system to the top of the chase or chimney.

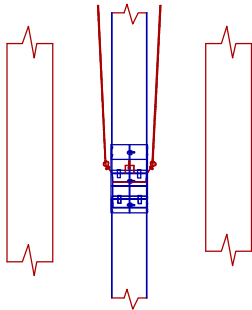

1. Install the (first) Guy section at approximately the mid point of any continuous vertical run but in no case further than 50 feet above or below a bottom support, roof jack or additional Guy Section. On single wall Saf-T Vent systems the Guy Section attaches exactly as described in the Saf-T Vent Installation and Maintenance Instructions. On double wall Saf-T CI Vent systems the Guy Section requires the special notched Coupler specially fitted around the anchor tabs.
2. Attach stainless steel or galvanized cable with a minimum rated capacity of 500 lbs to each of the 4 anchor holes.
3. Continue installing sections and feeding cable, attaching additional Guy Sections as required, until the Vent is properly positioned. Attach the top end of the Cables to solid masonry or other rigid building member.

Installation Above the Roof Line

When the Saf-T Vent or Saf-T CI Vent must extend above the roof line more than 6 feet the Guy section must be used to stabilize the system.

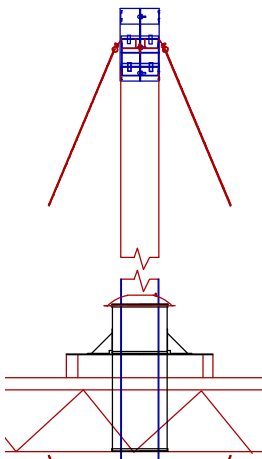

1. Install the Guy section 1 Vent section (2' length or less) below the Rain Cap Vertical Termination. On single wall Saf-T Vent systems the Guy Section attaches exactly as described in the Saf-T Vent Installation and Maintenance Instructions. On Double Wall Saf-T CI Vent systems the Guy Section requires the special notched Coupler specially fitted around the anchor tabs.
2. Attach stainless steel or galvanized cable with a minimum rated capacity of 500 lbs to each of the 4 anchor holes.
3. Securely anchor the cables to a rigid building member using appropriate anchors.
4. If there is no solid anchor point in the system below the Saf-T Vent Roof Support Jack an additional Guy Section must be used 'Below the Ceiling/Roof Structure' as described in the following section.

Installation Below a Ceiling/Roof Structure

When the Saf-T Vent or Saf-T CI Vent must extend down below a Saf-T Vent Roof Support Jack more than 30 Feet or if the system extends above the roof jack more than 6 feet, and is supported by a Guy Section above the roof line.

1. Attach the guy section at any point before an elbow or tee in the vertical drop within 30 feet of the roof support system
2. Attach stainless steel or galvanized cable with a minimum rated capacity of 500 lbs to each of the 4 anchor holes.
3. Securely anchor the cables to a rigid building member using appropriate anchors.

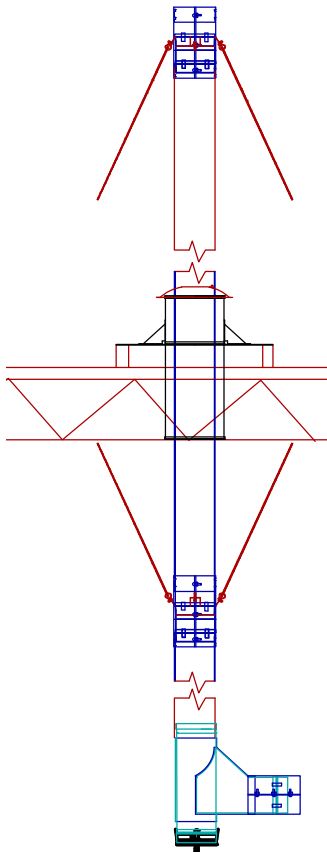

Detailed Installation Instructions for Saf-T CI Vent/Saf-T Vent Wall Penetration Assembly and Horizontal Termination

The Saf-T Vent and Saf-T CI Vent systems can be installed through any type of wall using the Saf-T CI Vent Wall Penetration Assembly. The wall penetration requires mechanical support from the wall sufficient to support any incidental loads on the system. If the wall is not sufficient to support the penetration assembly, then appropriate additional framing and/or blocking is required.

Installation Procedure

The Wall Penetration Assembly is packed with the screen cover loosely slid over the inside end of the assembly. Before beginning, remove this screen cover. Prepare an opening for the Wall Penetration Assembly in the wall. The opening must be 5 inches larger than the nominal diameter of the Saf-T Vent system when passing through combustible construction materials. The opening may be either round or square so long as allowance for proper clearance to combustible material is made. When passing through solid, noncombustible construction, clearances

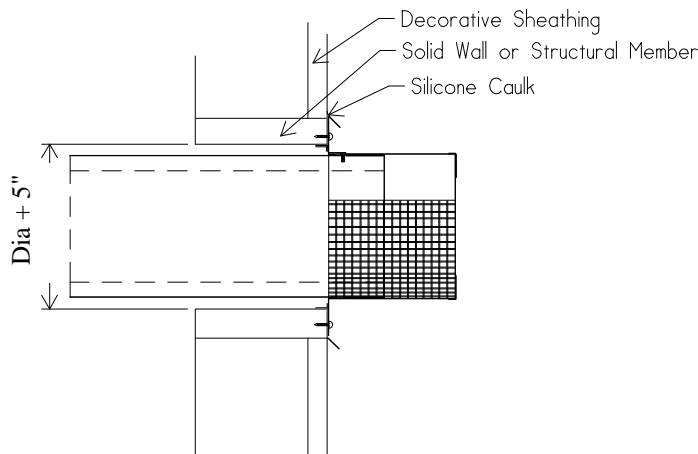

may be reduced if necessary. If there are not sufficient support members to secure the Wall Penetration Assembly or if there is a semirigid foam insulation layer under the sheathing, the opening must be blocked out or framed to provide support.

Position the Wall Penetration Assembly into the enlarged hole from the outside. Secure the assembly into the prepared opening using hollow wall anchors or wood screws as indicated by sheathing or structural members, sealing under the screw heads with caulking. (Use 4 hollow wall anchors, at least 1/4 inch in diameter and of an appropriate length for the thickness of the sheathing, if the sheathing is particle board or other composite material. Use (4) #10 x 1-1/4" wood screws for plywood or solid wood

sheathing or solid wood members. Use suitable masonry anchors when passing through solid masonry walls. Additional fasteners may be used if desired.) Reinstall the decorative sheathing around the Wall Penetration Assembly. The assembly may be painted to match the exterior decor.

Proceed with the installation of Saf-T Vent or Saf-T CI Vent sections and terminate it through the inside of the Wall Penetration Assembly. The assembly is constructed to allow for 2 degrees (1/4" per foot) of pitch in the vent sections. Seal the gap between the vent and the end plate of the termination using Dow Corning 732, GE 106 or other silicone caulk suitable for extended exposure to the elements.

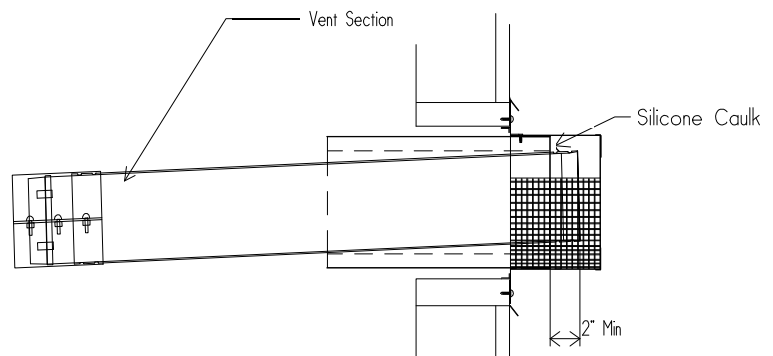

The vent section must protrude at least 2 inches into the screened area beyond the end plate of the Wall Penetration Assembly. Attach the screen cover using the stainless screw(s). Align the hole in the top (solid) portion of the screen cover with the hole in the thimble assembly and securely screw the two together. The screen cover may be easily removed for inspection of the venting system. If local conditions require, the exterior portion may be extended using single wall AL 29-4C stainless pipe to extend the screen cover so long as the vent section extends 2" into the screened area. Alternately the screen cover may be removed and a Saf-T Vent screened mitre termination or other terminal Listed for use with specific appliances may be utilized.