

Scan to watch the installation video
<https://delivr.com/2eyqn>



IMPORTANT:

Before you begin, make sure you familiarize yourself with all the parts and fully read the instructions.

CUSTOMER SERVICE:

Toll free customer help line available weekdays between 7:00am and 6:00pm Central Time at 800-463-0660.

TOOLS NECESSARY:

Screw gun or Phillips screwdriver and tape measure. NOTE: If screw gun has a clutch, set to lowest setting so as not to over tighten and/or strip screws.

PARTS IDENTIFICATION:

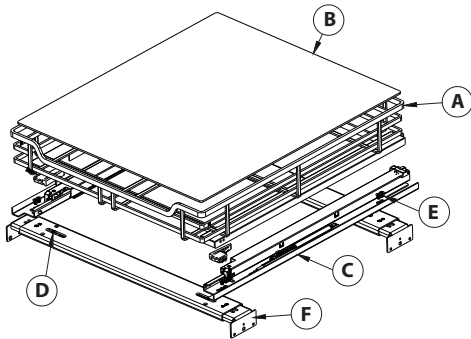

A	Basket Organizer	1 pcs
B	Bottom Panel Liner	1 pcs
C	Slide Assembly	1 pcs
D	Extension Arm Screws	4 pcs
E	Slide Mounting Screws	8 pcs
F	Extension Arm	4 pcs

SIDE MOUNT INSTALLATION

STEP 1



Remove the bottom insert panel. Remove the basket from the slides by pressing inward on the slide release clip.

STEP 2

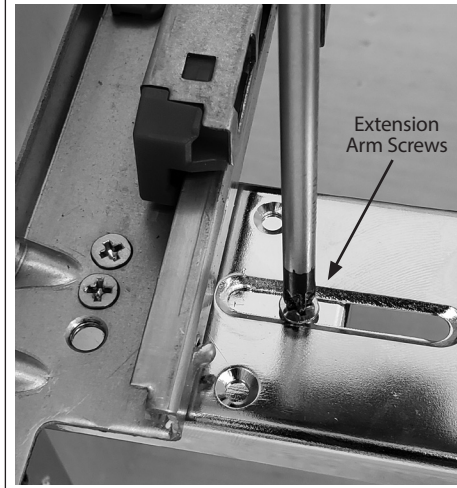

Loosen the Extension Arm Screws (D).

STEP 3

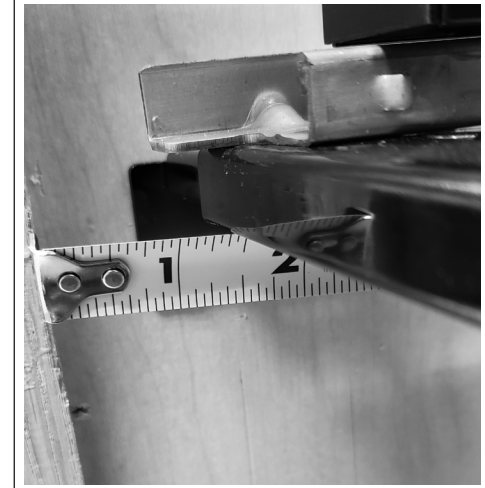

Measure 1-3/8" from behind face frame to the Slide Assembly (C).

STEP 4

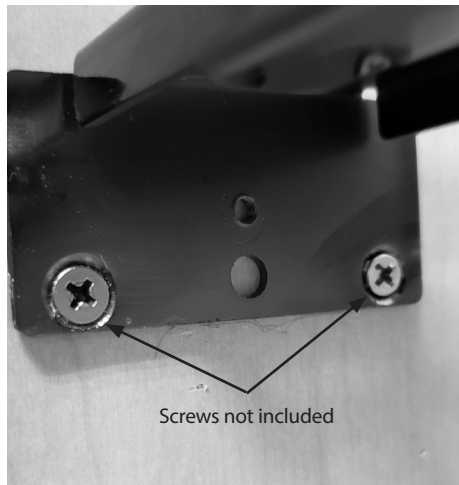

Use 8 - #8 x 3/8" flat head screws (not included) to affix Extension Arms (F) to the side of the cabinet.

STEP 5

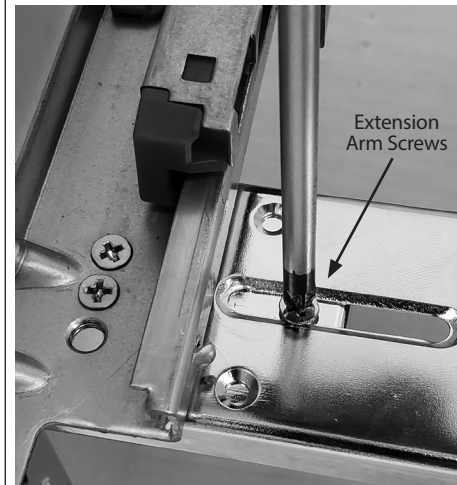

Tighten Extension Arms Screws (D) at desired location.

STEP 6



Reattach Basket Organizer (A) to Slide Assembly (C) by pushing back until audible click.

BOTTOM MOUNT INSTALLATION

STEP 1



Remove the bottom insert panel. Remove the basket from the slides by pressing inward on the slide release clip.

STEP 2

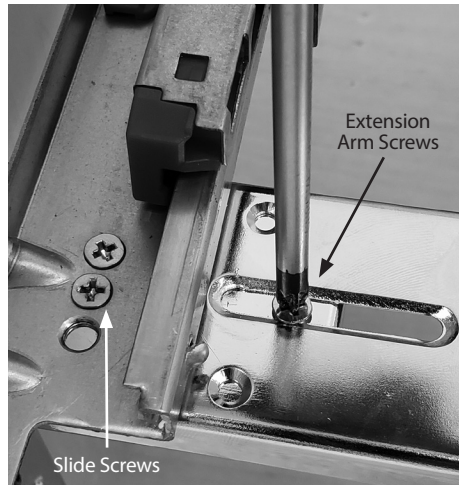

Remove the Extension Arm Screws (D) and loosen the Slide Mounting Screws (E) from slides.

STEP 3



Remove 4 - Extension Arms (F) from Slide Assembly (C).

STEP 4

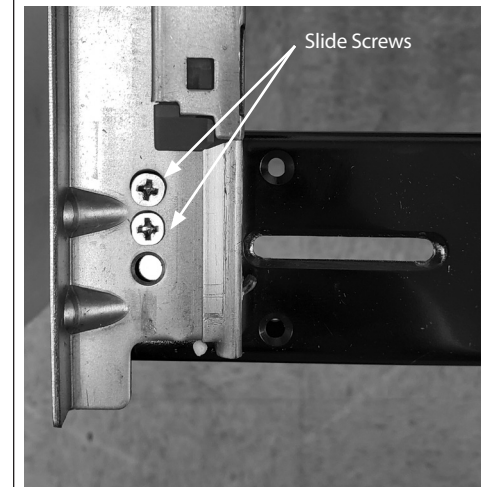

Tighten Slide Screws back up.

STEP 5

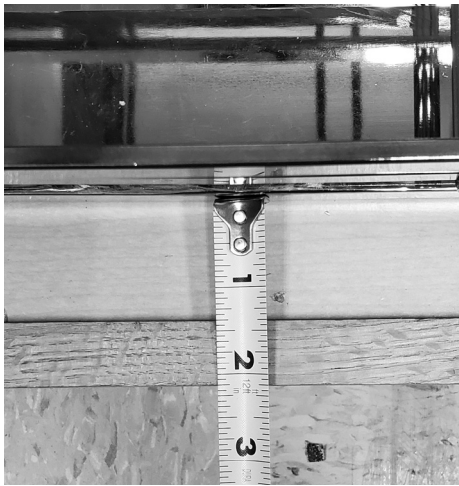

Measure 1-3/8" from behind face frame to the Slide Assembly (C).

STEP 6

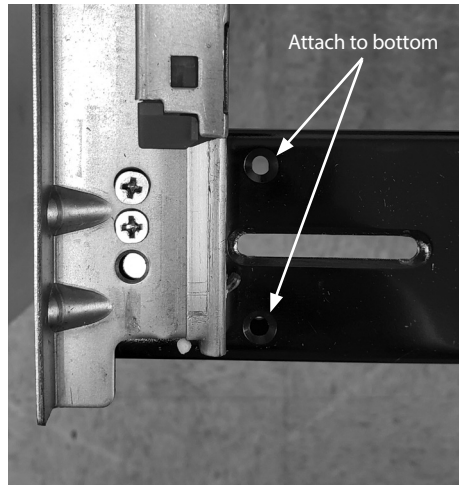

Attach to bottom of cabinet using #8 x 1" flat head screws. (Included)

STEP 7



Reattach Basket Organizer (A) to Slide Assembly (C) by pushing back until audible click.