

AXOR[®]

hansgrohe

- EN** Installation / User Instructions / Warranty
- FR** Instructions de montage / Mode d'emploi / Garantie
- ES** Instrucciones de montaje / Manejo / Garantía



04313000

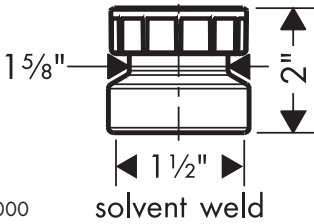

04313000

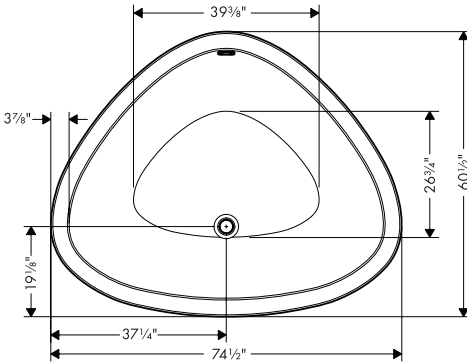

Axor Massaud
18950000

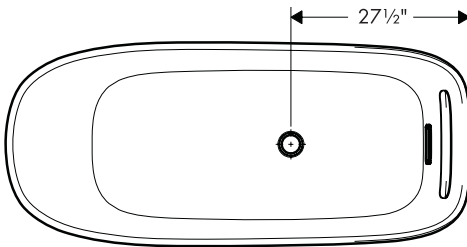

Axor Urquiola
11440000

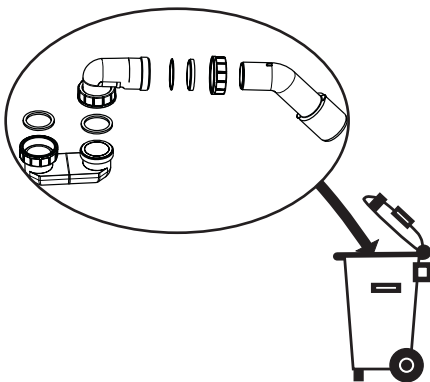

Installation Considerations:

- For best results, Hansgrohe recommends that this unit be installed by a licensed, professional plumber. Follow all applicable local plumbing codes when installing the tub.
- **This tub requires a 1 1/2" PVC waste pipe, extending 1 1/2" above the surface of the finished floor.**
- Installation of this tub requires at least two people. **Do not attempt to install this tub alone.**
- Inspect the tub for shipping damage immediately upon delivery to the jobsite. If the tub is damaged, refuse the shipment. **Do not install a damaged tub.** Claims for shipping damage will not be honored after the tub is installed.
- Keep this booklet and the receipt (or other proof of date and place of purchase) for this product in a safe place. The receipt is required should it be necessary to request warranty parts.

Warning

The Massaud / Urquiola tub is packed with a European drain assembly.



Do not attempt to install the European drain in the USA.



Use of this drain in the USA will result in a double-trapped drain, which will provide unsatisfactory drainage of the tub.

À prendre en considération pour l'installation

- Pour de meilleurs résultats, Hansgrohe recommande que ce produit soit installé par un plombier professionnel licencié.
- **Cette baignoire nécessite l'utilisation d'un tuyau de vidange en PVC de 1 ½ po, dont une partie de 1 ½ po doit se trouver au-dessus de la surface du plancher fini.**
- L'installation de cette baignoire doit être effectuée par au moins deux personnes. **N'installez pas cette baignoire si vous êtes seul.**
- Inspectez la baignoire dès la livraison sur le site d'installation pour vérifier si elle a été endommagée lors du transport. Si la baignoire est endommagée, refusez l'envoi. **N'installez pas de baignoire endommagée.** Les réclamations pour tout dommage survenu lors de la livraison ne seront pas acceptées après l'installation de la baignoire.
- Conservez ce livret et le reçu (ou une autre preuve sur laquelle figurent la date et l'endroit de l'achat) pour ce produit dans un endroit sûr. Le reçu est requis si vous commandez des pièces sous garantie.

Avis

La baignoire Massaud / Urquiola est emballée avec un assemblage de drain européen.



Ne tentez pas d'installer le drain européen aux États-Unis.



L'utilisation de ce drain aux États-Unis produirait un drain doublement enseveli qui n'offrirait pas un écoulement satisfaisant pour la baignoire.

Consideraciones para la instalación

- Para obtener mejores resultados, la instalación debe estar a cargo de un plomero profesional matriculado.
- **Esta bañera requiere un tubo de descarga de PVC de 1 ½", que sobresalga 1 ½" de la superficie del acabado del piso.**
- Se requieren al menos dos personas para la instalación de esta bañera. **No intente instalarla usted solo.**
- Inspeccione la bañera para observar que no haya daños causados por el transporte inmediatamente al momento de la entrega en el lugar de trabajo. Si la bañera está dañada, rechace el envío. **No instale una bañera dañada.** Los reclamos por daños causados por el transporte no se aceptarán luego de que se instale la bañera.
- Mantenga este folleto y el recibo (u otro comprobante del lugar y fecha de compra) de este producto en lugar seguro. El recibo se requiere en caso de ser necesario solicitar piezas bajo garantía.

Aviso

La bañera Massaud / Urquiola está embalada con un conjunto de drenaje europeo.



No intente instalar el drenaje europeo en los Estados Unidos.



El uso de este drenaje en los Estados Unidos puede producir un desagüe doble trampa, lo que no proporcionará un desagüe satisfactorio de la bañera.

Adapter Installation

This tub requires a 1 1/2" PVC waste pipe, extending 1 1/2" above the surface of the finished floor.

Seal the floor around the waste pipe using waterproof sealant.

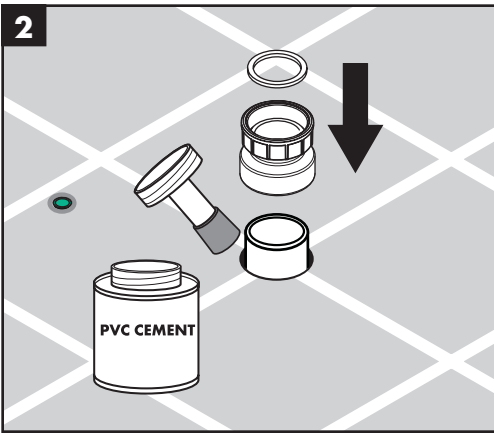
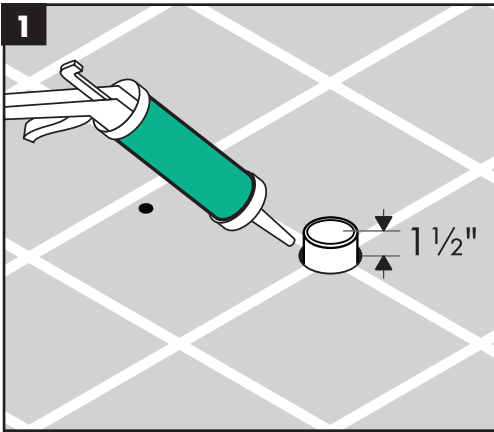

Solvent weld the adapter to the pipe.

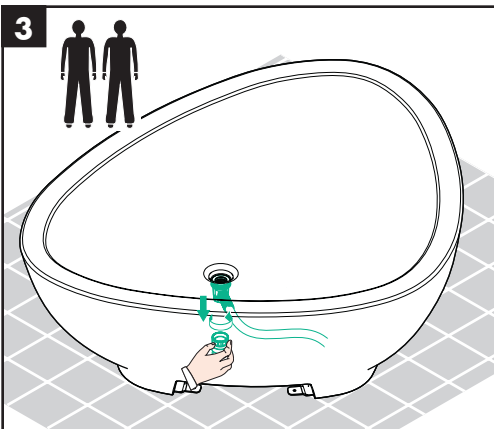

Position the tub over the drain.

Tighten the nut.

Continue the installation according to the manual included with the bathtub.

Installation de l'adaptateur

Cette baignoire nécessite l'utilisation d'un tuyau de vidange en PVC de 1 1/2 po, dont une partie de 1 1/2 po doit se trouver au-dessus de la surface du plancher fini.

Scellez le plancher autour de l'orifice de sortie à l'aide d'un agent d'étanchéité.

Collez par solvant l'adaptateur au tuyau de vidange.

Placez la baignoire au-dessus du tuyau de vidange et descendez-la sur sa position.

Serrez l'écrou du drain.

Continuer l'installation selon le manuel inclus avec la baignoire.

Instalación del adaptador

Esta bañera requiere un tubo de descarga de PVC de 1 1/2", que sobresalga 1 1/2" de la superficie del acabado del piso.

Selle el piso alrededor de la salida con un sellador impermeable.

Suelde con solvente el adaptador al tubo de descarga.

Coloque la bañera sobre el tubo de descarga y bájela hasta que quede en su sitio.

Apriete la tuerca de drenaje.

Continúe la instalación según el manual incluido con la bañera.

Care and Maintenance Instructions

Maintenance

After bathing, empty the tub. If using a rubber or plastic anti-slip mat, remove it to prevent damage to the tub surface.

Clean the tub regularly. Use only bathroom cleaning products specifically intended for use on fiberglass.

Use a soft cleaning cloth or sponge.

Immediately rinse the tub thoroughly with clear water when finished cleaning. Do not allow cleaning products to remain on the tub.

Do not use:

- abrasive or caustic cleaning products.
- abrasive cleaning cloths, pads, or brushes.
- no-rinse cleaning agents.

Entretien

Une fois le bain terminé, videz la baignoire. Si vous utilisez un tapis antidérapant en caoutchouc ou plastique, retirez-le pour éviter d'endommager la surface de la baignoire.

Nettoyez la baignoire régulièrement. Utilisez uniquement des produits de nettoyage pour baignoire conçus spécialement pour la fibre de verre.

Utilisez une éponge ou un chiffon doux.

Rincez bien la baignoire avec de l'eau claire après le nettoyage. Ne laissez pas de produits de nettoyage dans la baignoire.

N'utilisez pas:

- de produits de nettoyage abrasifs ou caustiques.
- de brosses, chiffons ou tampons abrasifs.
- de produits de nettoyage sans rinçage.

Mantenimiento

Luego de bañarse, vacíe la bañera. Si utiliza un tapete de caucho o de plástico antideslizante, retírelo para evitar que se provoquen daños en la superficie de la bañera.

Limpie la bañera con regularidad. Utilice únicamente productos de limpieza para baños que estén preparados específicamente para ser utilizados en fibra de vidrio.

Utilice un paño de limpieza suave o una esponja.

Enjuague la bañera a fondo con agua limpia cuando termine de limpiar. No permita que los productos de limpieza permanezcan en la bañera.

No utilice:

- productos de limpieza abrasivos o cáusticos.
- paños limpiadores, estropajos o cepillos abrasivos.
- agentes de limpieza sin enjuague.

Limited Consumer Warranty

This product has been manufactured and tested to the highest quality standards by Hansgrohe, Inc. ("Hansgrohe"). This warranty is limited to Hansgrohe products that are purchased by a consumer in the United States or Canada after March 1, 1996, and installed in either in the United States or in Canada.

WHO IS COVERED BY THE WARRANTY

This warranty extends to the original purchaser only. This warranty is non-transferable.

WHAT IS COVERED BY THE WARRANTY

The warranty covers only your Hansgrohe manufactured product. Hansgrohe warrants this product against defects in material or workmanship as follows:

Hansgrohe will replace at no charge for parts only or, at its option, replace any product or part of the product that proves defective because of improper workmanship and/or material, under normal installation, use, service and maintenance. If Hansgrohe is unable to provide a replacement and repair is not practical or cannot be made in timely fashion, Hansgrohe may elect to refund the purchase price in exchange for the return of the product.

LENGTH OF WARRANTY

Replacement or repaired parts of products will be covered for the term of this warranty, as stated in the following two sentences. If you are a consumer who purchased the product for use primarily for personal, family or household purposes, this warranty extends for as long as you own the product and the home in which the product is originally installed. If you purchased the product for use primarily for any other purpose, including, without limitation, a commercial purpose, this warranty extends only (i) for 1 year, with respect to Hansgrohe & Commercial products, and (ii) for 5 years, with respect to Axor products.

THIS WARRANTY DOES NOT COVER, AND HANSGROHE WILL NOT PAY FOR:

- A. Conditions, malfunctions or damage not resulting from defects in material or workmanship.
- B. Conditions, malfunctions or damage resulting from (1) normal wear and tear, improper installation, improper maintenance, misuse, abuse, negligence, accident or alteration; (2) the use of abrasive or caustic cleaning agents or "no-rinse" cleaning products, or the use of the product in any manner contrary to the product instructions; or (3) conditions in the home such as excessive water pressure or corrosion.
- C. Labor and other expenses for disconnection, deinstallation, or return of the product for warranty service (including but not limited to proper packaging and shipping costs), or for installation or reinstallation of the product.
- D. Accessories, connected materials and products, or related products not manufactured by Hansgrohe.
- E. Any Hansgrohe or Axor product sold for display purposes.
- F. Rubbed Bronze finish is subject to a 3-year limited warranty. Chrome and all PVD finishes are covered by the limited lifetime warranty.
- G. Hansgrohe Water Filtration System is subject to a 1-year limited warranty. Warranty does not include replacement filters.

TO OBTAIN WARRANTY PARTS OR INFORMATION

Contact your Hansgrohe retailer, or contact Technical Service at:

Hansgrohe, Inc.
1492 Bluegrass Lakes Parkway
Alpharetta, GA 30004
Toll-free 800-334-0455

In requesting warranty service, you will need to provide:

1. The sales receipt or other evidence of the date and place of purchase.
2. A description of the problem.
3. Delivery of the product or the defective part, postage prepaid and carefully packed and insured, to:

Hansgrohe, Inc.
1492 Bluegrass Lakes Parkway
Alpharetta, GA 30004
Toll-free 800-334-0455

When warranty service is completed, any repaired or replacement product or part will be returned to you postage prepaid.

EXCLUSIONS AND LIMITATIONS

REPAIR OR REPLACEMENT (OR, IN LIMITED CIRCUMSTANCES, REFUND OF THE PURCHASE PRICE) AS PROVIDED UNDER THIS WARRANTY IS THE EXCLUSIVE REMEDY OF THE PURCHASER. HANSGROHE NEITHER ASSUMES NOR AUTHORIZES ANY PERSON TO CREATE FOR IT ANY OTHER OBLIGATION OR LIABILITY IN CONNECTION WITH THIS PRODUCT. HANSGROHE SHALL NOT BE LIABLE TO PURCHASER OR ANY OTHER PERSON FOR ANY INCIDENTAL, SPECIAL OR CONSEQUENTIAL DAMAGES, ARISING OUT OF BREACH OF THIS WARRANTY OR ANY IMPLIED WARRANTY (INCLUDING BUT NOT LIMITED TO ANY IMPLIED WARRANTY OF MERCHANTABILITY).

Some States do not allow the exclusion or limitation of incidental or consequential damages, so the above limitation or exclusion may not apply to you. This warranty gives you specific legal rights, and you may also have other rights that vary from state to state.

TO THE EXTENT PERMITTED BY LAW, ANY IMPLIED WARRANTIES OF MERCHANTABILITY AND FITNESS FOR A PARTICULAR PURPOSE, ARE LIMITED TO THE DURATION OF THE EXPRESS WARRANTY.

Some states do not allow limitations on how long an implied warranty may last, so the above limitations may not apply to you. You may be required by law to give us a reasonable opportunity to correct or cure any failure to comply before you can bring any action in court against us under the Magnuson-Moss Warranty Act.

PRODUCT INSTRUCTIONS AND QUESTIONS

Upon purchase or prior to installation, please carefully inspect your Hansgrohe product for any damage or visible defect. Prior to installing, always carefully study the enclosed instructions on the proper installation and the care and maintenance of this product. If you have questions at any time about the use, installation or performance of your Hansgrohe product, or this warranty, please write us or call us toll-free at 800-334-0455.

hansgrohe

Hansgrohe, Inc. • 1490 Bluegrass Lakes Parkway • Alpharetta, GA 30004
Tel. 800-334-0455 • Fax 770-360-9887

www.hansgrohe-usa.com