



## Assembly & Care Guide For Bathroom Vanity

The model number of your vanity is printed on the side of your carton.

Always use this number to identify your vanity.

Thank you for your purchase of this quality bathroom vanity. With proper use and care, your vanity will provide you with years of use. Please follow the instructions on how to install your vanity. If you should have any problems with your vanity DO NOT return it to the place of purchase.

Please call our toll free number: **877-397-5144** or email us at **contactus@hanover-products.com** and a customer service representative will assist you.

# Bathroom Vanity Installation Guide

## Please note:

- Plumbing fixtures, parts, and hardware are not included. We recommend consulting with a licensed plumber prior to installation. All required plumbing parts shown in the diagrams can be purchased at most hardware stores. Your items may appear slightly different from illustrations.
- Protect all surfaces from sharp objects, high heat sources, direct prolonged sunlight, and chemical hazards.

## Required Tools – NOT INCLUDED

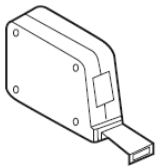

Tape Measure



Pencil



Electric Drill

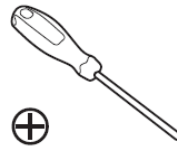

Phillips Screwdriver

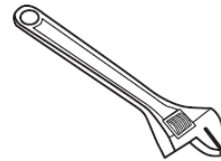

Adjustable Wrench

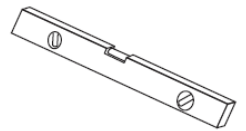

Spirit Level

## Parts Included:

Your vanity is pre-assembled and therefore has very few parts.

Your package should include the following.

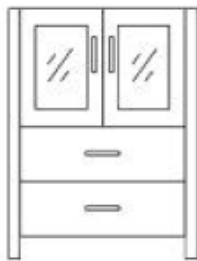

Base Cabinet

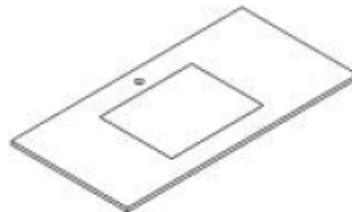
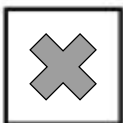

Counter Top

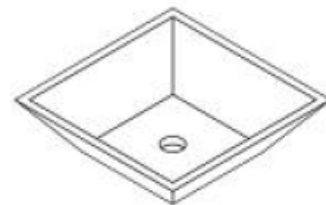
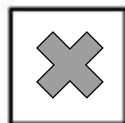

Sink(s)

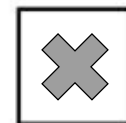

## How to handle your counter top

It is recommended to have 2 strong adults to handle the counter top

Lift the pre-assembled counter top and sink basin from the front side, leaving the back side on the bottom of the packaging. Bring to a vertical position and maintain vertical position during any moving of the counter top.

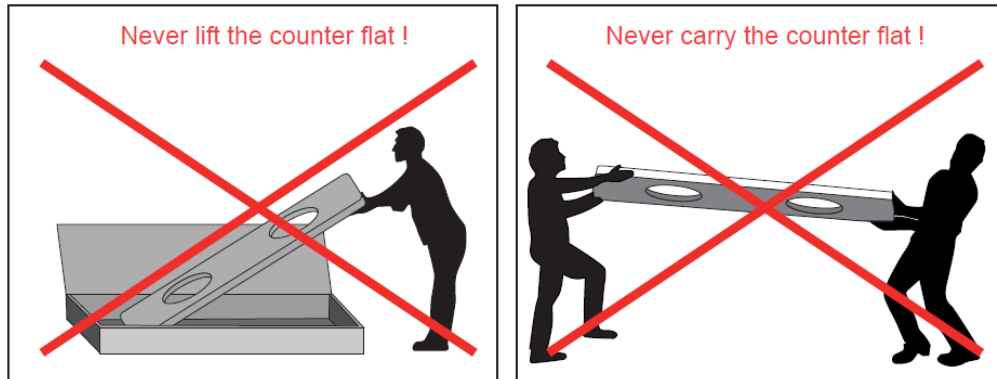

## How to adjust the hinges

Adjust height

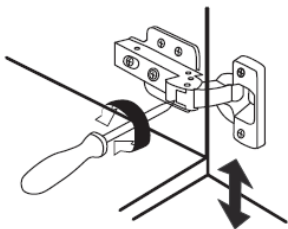

Adjust laterally

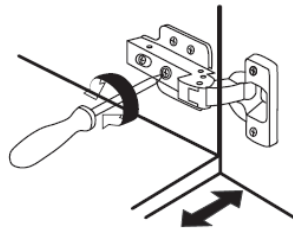

Adjust depth

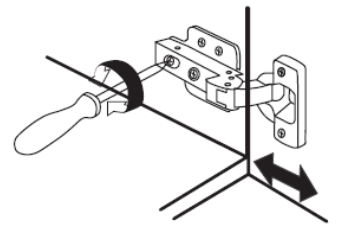

## How to remove and install the drawers

Removal

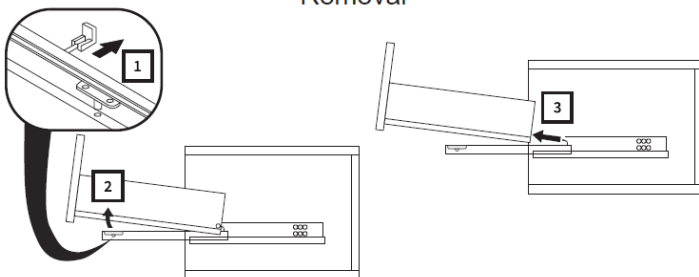

Installation

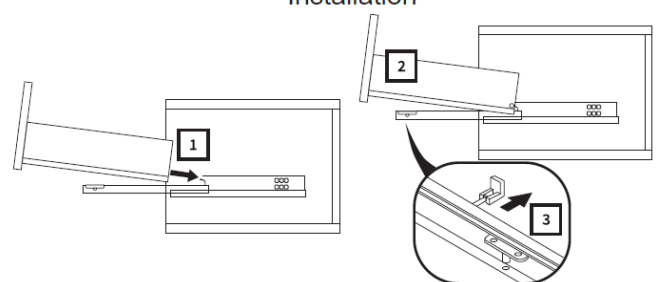

## Counter top and sink installation

Counter tops should be handled with extreme caution and should always be lifted vertically and be maintained in a vertical position while lifting, never lift or carry your counter top in a flat position. See [How to handle your counter top](#) on previous page.

1. Safely remove the packaging from your preassembled counter top and sink and place it on a flat surface. Place your counter top on an even flat surface to prevent any movements.

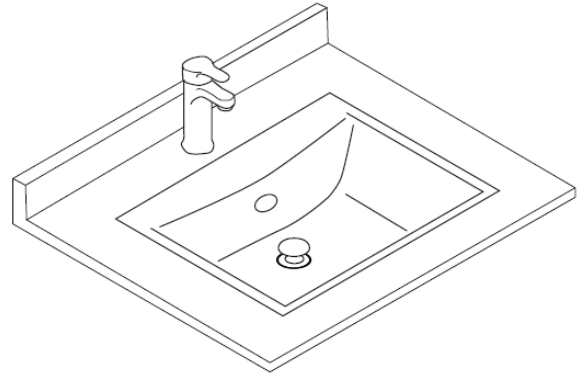

2. Remove the double sided tape strip that is located on top of the base cabinet. Lift the counter top in a vertical position and carefully place on top of the vanity cabinet. It is best to align the countertop with your cabinet base from back to front. We recommend 2 adults to lift and place counter top to avoid any potential breakage that may occur during installation. *Damages incurred during the installation process are not covered under warranty.*

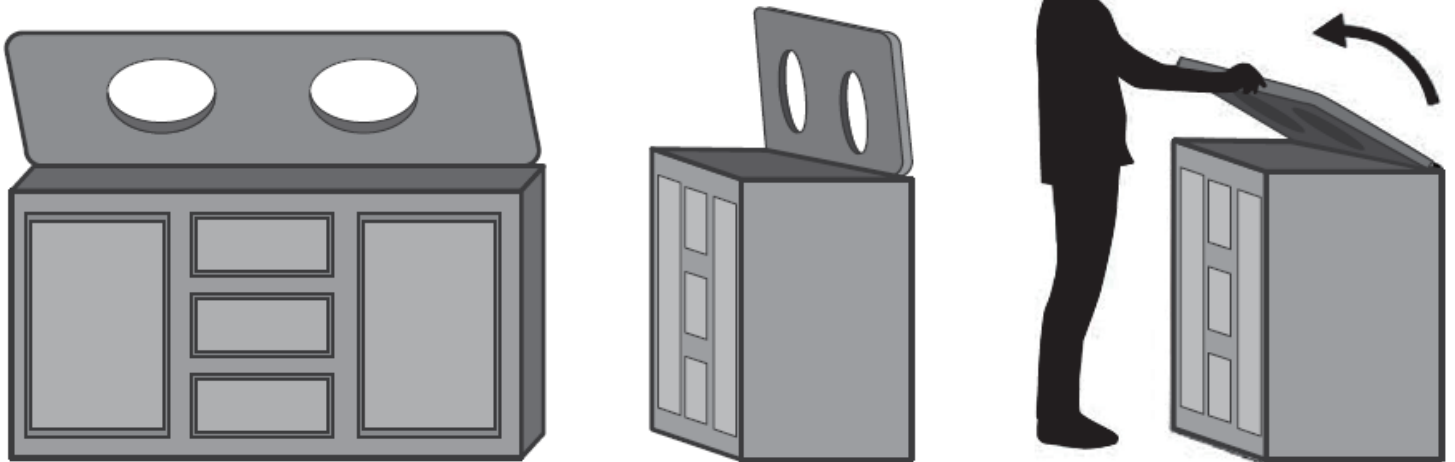

## Pop-Up Drain and P-Trap Installation

It is strongly recommended to hire a licensed plumber to properly install the drain and water connections.

For the recommended Pop-up Drain and P-Tray installation, please see the diagram below. The diagram will specify the process and parts needed for installation. Due to a large variety of plumbing applications and city and state codes plumbing parts and other components are not included. Your item may appear slightly different from illustration. These components can be purchased at most hardware stores.

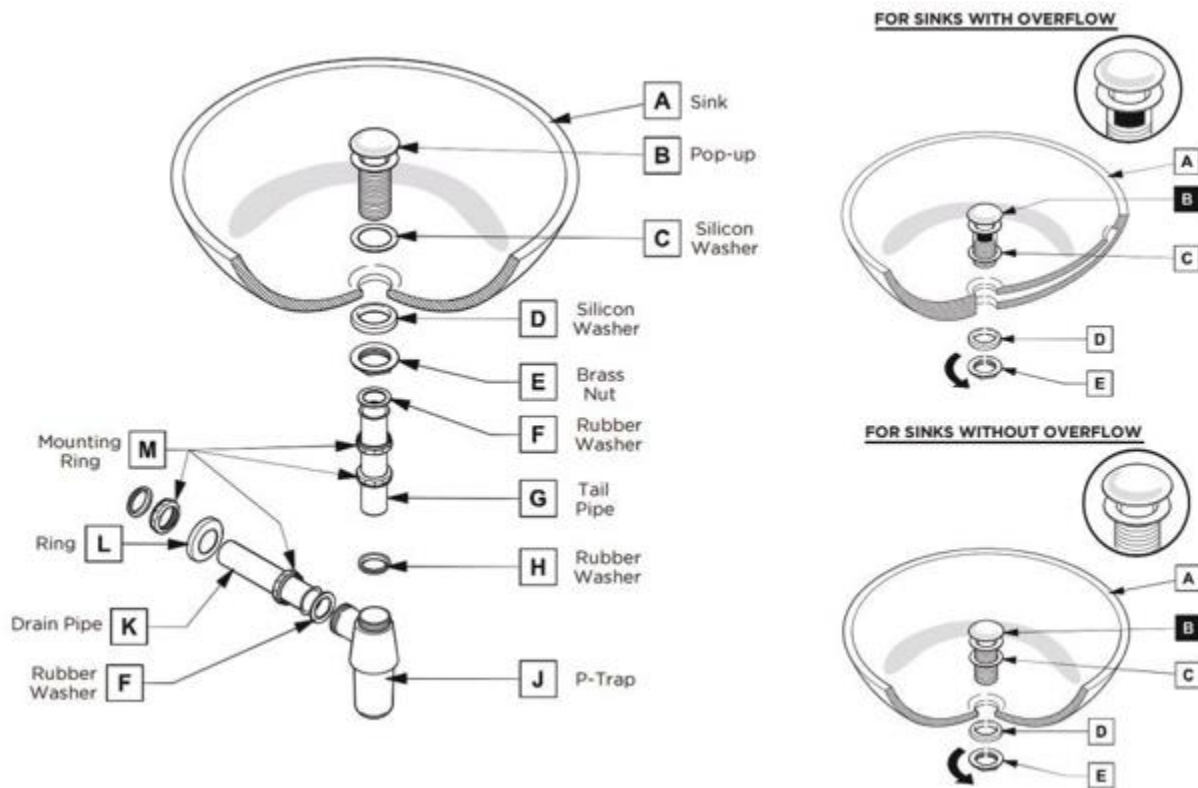

# Indoor Furniture

## 1-Year Limited Warranty Program

For a period of one (1) year after purchase, Hanover Products ("Manufacturer") will either repair or replace defective components in accordance with this Limited Warranty. This warranty is between Manufacturer and the original purchaser and is valid only when accompanied by the original purchaser's sales receipt showing original date of purchase and location of purchase. Replacements under this warranty revert back to the date of original purchase for future warranty.

Manufacturer or its authorized dealer can accept or reject warranty claims based on its findings. This warranty applies in normal residential use only and is not intended for commercial use. Manufacturer can make substitutions as required of materials, components, and sub-components of comparable value and utility. This warranty is limited to product repair or replacement (to be determined solely by Manufacturer). Warranty return is limited to only the single affected component.

This warranty covers only manufacturing defects and does not cover normal wear and tear, abuse or misuse, exposure to extreme heat or cold, abrasion or excessive weight. This product is intended to be used in standard installations only. This warranty is invalid if the product is not used for intended purpose. Manufacturer disclaims liability for any aspect of installation and any inconvenience caused by a defective part of a component.

Certain items are not covered by this warranty. These include, but are not limited to the following:

1. Components subjected to abuse, including abuse intended to simulate failure.
2. Damages caused by retailer, shipper or installation crew (such as scratches, dents, tears, chips, etc.).
3. Any part which merely exhibits normal wear yet functions essentially as new, including chips, scratches or stretching of materials and stitching.
4. Tears, punctures, scratches or any damage caused by improper installation or use.
5. Damage to frames/welds resulting from improper assembly is not covered. General frame rusting is not covered.
6. Fading and/or discoloration of fabrics resulting from exposure to the elements, chemicals, oils, fluids or any other cause are not covered.

To make a claim, call the toll-free number below. Please have available a copy of the original sales receipt along with a brief description of the problem. Please also provide your email address and daytime telephone or cell phone #. All items may be charged actual freight costs plus \$15 for handling. Repairs or replacement will be made at the Manufacturer's option. ***Sales and use taxes, plus shipping and handling charges are the responsibility of the consumer.***

**THIS IS THE ENTIRE EXCLUSIVE EXPRESS LIMITED LIABILITY. THE MANUFACTURER NEITHER MAKES NOR IS RESPONSIBLE FOR ANY OTHER WARRANTIES, EITHER EXPRESS OR IMPLIED, INCLUDING THOSE OF RETAILING DEALERS. THIS EXCLUSIVE REMEDY IS LIMITED TO RECEIPT OF A CREDIT IN CONNECTION WITH THE REPAIR OR REPLACEMENT OF ANY PRODUCT OR COMPONENT DEEMED TO BE DEFECTIVE UNDER THE TERMS AND CONDITIONS AS STATED IN THIS WARRANTY. NEITHER CAMBRIDGE PRODUCTS, THE PRODUCT MANUFACTURER NOR ITS AGENTS SHALL BE LIABLE IN ANY CASE FOR INCIDENTAL, INDIRECT, SPECIAL OR CONSEQUENTIAL DAMAGES RESULTING FROM THE USE OF THIS PRODUCT OR ARISING OUT OF ANY BREACH OF THIS WARRANTY OR NEGLIGENCE EVEN IF IT HAS BEEN ADVISED OF THE POSSIBILITY OF SUCH DAMAGES. EXCEPT AS OTHERWISE MAY BE REQUIRED BY LAW, THERE ARE NO OTHER EXPRESS OR IMPLIED WARRANTIES OTHER THAN THE WARRANTY DESCRIBED HEREIN, AND ALL OTHER WARRANTIES, INCLUDING ANY IMPLIED WARRANTY OF MERCHANTABILITY OR FITNESS FOR A PARTICULAR PURPOSE ARE EXPRESSLY DISCLAIMED.**

**Contact Warranty Services at**

**1-877-397-5144**

**or**

**contactus@hanover-products.com**