

HANOVER®

Hanover Outdoor Furniture



IMPORTANT

If you have any problems with this product (missing or damaged parts, assembly issues, etc.),

PLEASE DO NOT RETURN TO THE RETAILER/STORE

from where you purchased the product.

Please call our Toll-Free Customer Service Hotline at: **1-800-416-3511**

Between 9:00 AM and 5:00 PM Eastern Time, Monday through Friday

Or visit our website at: **www.hanover-products.com**

To expedite any future warranty claims, please retain the Instruction Sheet, Warranty Card and receipt for future use.

For additional on-line support on assembly, troubleshooting and care & maintenance of your outdoor furniture, please visit our website at: **www.hanover-products.com**.

**IMPORTANT!! PLEASE READ ENTIRE INSTRUCTION SHEET BEFORE ASSEMBLY!!
TO EXPEDITE ANY FUTURE WARRANTY CLAIMS, PLEASE KEEP INSTRUCTION SHEET, WARRANTY CARD AND RECEIPT**

Step 1: Remove all protective materials and set parts on a flat, non-abrasive surface. Identify parts packed in carton against the parts list. If you are missing any parts or are unsure how to proceed with assembly, call our Customer Service Center at 1-800-416-3511. **Do not attempt assembly if any parts are missing or damaged.**

Step 2: Place the table top upside down on a flat, non-abrasive surface. Attach a table leg to the table top by using the bolt and washer as shown in **Fig.1**. Place the leg beneath the table top corner bracket and into the pre-drilled hole in the table leg. **Hand tighten only 3-4 revolutions only. Do not tighten completely.** Repeat for the other three legs.

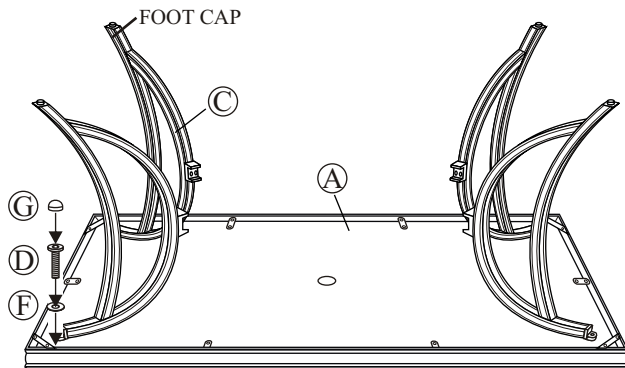

Fig.1

Step3: Attach a leg to the leg connector bracket by carefully guiding the bolts already in place on the table legs (each leg has two bolts) through the holes in the leg connector bracket. Add a washer and a nut to the end of each bolt as shown in **Fig.2**. **Hand tighten only. Do not tighten completely.** Repeat on the other three legs.

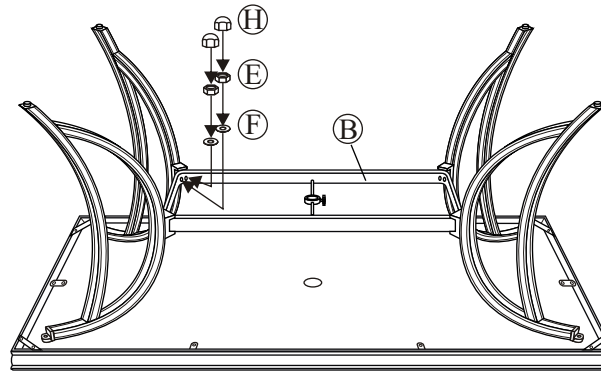











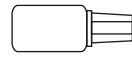



Fig.2

Step 4: After making any necessary adjustments to the alignment of the table legs and the leg connector bracket, use the hex bolt driver and hex wrench to tighten all nuts and bolts. **Note:** each bolt and nut must be tightened a few revolutions at a time. In order to apply equal pressure to all bolt joints, we recommend working in a cross corner (X fashion). Repeat until all bolts are tight. **Do not over tighten.** Over tightening may strip bolts. Cover all nuts and bolts with covers.

Step 5: With the help of another person, turn the table in the upright position. Your table is now ready for use. If you have any questions, please call our Customer Service Center at 1-800-416-3511.

IMPORTANT NOTE: Damage to welds or frames resulting from over tightened bolts or improper assembly is not covered under our warranty. Please read all instructions carefully before assembly. If you have any questions regarding your assembly, call our Customer Service Center at 1-800-416-3511.

** NOTE: PARTS SHOWN ON PARTS LIST ARE NOT TO SCALE*

	<u>PARTS LIST</u>	<u>DESCRIPTION</u>	<u>ORDER PART #</u>	<u>QTY</u>
A		TABLE TOP		1
B		LEG CONNECTOR BRACKET		1
C		TABLE LEG		4
D		1/4" X 25 MM BOLT	HW0037	4
E		1/4" NUT	HW0014	8
F		Ø6.5 X 1.0 MM WASHER	HW0004	12
G		BOLT COVER	HW0105	4
H		NUT COVER	HW0027	8
I		HEX WRENCH	HW0009	1
J		HEX BOLT DRIVER	HW0006	1
K		TOUCH-UP PAINT	G0003	1
		FOOT CAP FACTORY ASSEMBLY	FC0030	
		UMBRELLA POLE LOCK KNOB & NUT FACTORY ASSEMBLY	G0091 & HW0448	
		UMBRELLA HOLE PROTECTIVE RING FACTORY ASSEMBLY	G0157	

ALF41817

**IMPORTANT!! PLEASE READ ENTIRE INSTRUCTION SHEET BEFORE ASSEMBLY!!
TO EXPEDITE ANY FUTURE WARRANTY CLAIMS, PLEASE KEEP INSTRUCTION SHEET, WARRANTY CARD AND RECEIPT**

IMPORTANT NOTE: Your sling seat may appear to be slightly warped. This is not unusual. Proper assembly procedure will straighten out the sling seat in the frame. There are four bolts used to attach the seat frame to the seat base. After inserting all the bolts, each of these bolts must be tightened a few revolutions at a time in rotation.

Step 1: Identify all parts packed in the carton against the parts list. Remove all protective materials. Set parts on a flat, non-abrasive surface to avoid scratching. If you are missing any parts or are unsure how to proceed with assembly, call our Customer Service Center immediately at 1-800-416-3511. **Do not attempt to assemble chair if any parts are missing or damaged.**

IMPORTANT NOTE: Assembling this chair requires attaching the sling seat frame to the seat base. We recommend two people work together to assemble the chair since it is critical that all the holes in the seat frame are aligned exactly with the holes in the seat base. All bolts need to be inserted and tightened into the fixed nuts in a straight and direct path. Inserting the bolts at even the slightest angle could strip the nuts and bolts, damaging the entire chair.

Step 2: Working from behind the chair, have another person stand in front of the chair and position the sling seat frame in between the arms of the seat base as shown in **Fig.1** so that the holes on both sides of the upper portion of the seat frame back align with the fixed nut holes in the seat base.

Step 3: Working from the front of the chair, add a washer to a 1/4"x45 mm bolt. From the underside of the front seat support bar, insert the bolt with washer through one of the holes in the seat support bar, into the fixed nut inside the lower front portion of the seat base as shown in **Fig.2**. **Hand tighten 3-4 revolutions only. Do not tighten Completely.** Repeat for opposite side of chair.

Step 4: From behind the chair, insert a 1/4"x35 mm bolt through the back arm portion of the seat base and into the fixed nut in the seat frame as shown in **Fig.3**. Make sure the bolt is inserted exactly straight! **Hand tighten 3-4 revolution only. Do not tighten completely.** Repeat for opposite side of chair.

Step 5: Tighten all bolts with the hex bolt driver. Each bolt must be tightened a 3-4 revolutions only at a time. Begin with top left bolt. Move to bottom right bolt then to top right bolt, followed by bottom left bolt. Repeat this "X" pattern until all bolts are tight. **Do not over tighten bolts.** Over tightening may strip bolts or nuts, damaging the entire chair. Cover 1/4"x35 mm bolts with bolt covers.

Step 6: Examine the chair from the front. If the sling seat does not appear tight or straight in the seat base, repeat steps 3, 4 and 5. If you do not feel your chair is assembled properly, or you have any questions, call our Customer Service Center at 1-800-416-3511.

IMPORTANT NOTE: Damage to welds or frames resulting from over tightened bolts or improper assembly is not covered under our warranty. Please read all instructions carefully before assembly. If you have any questions regarding your assembly, call our Customer Service Center at 1-800-416-3511.

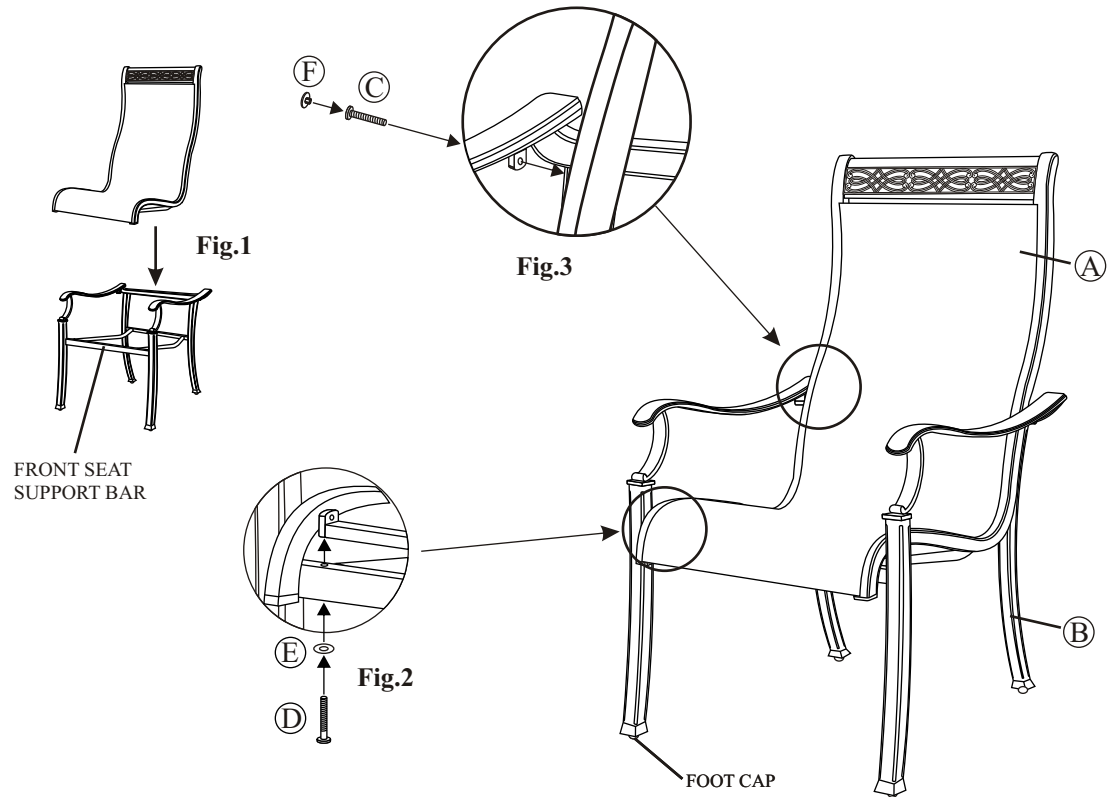

*NOTE: PARTS SHOWN ON PARTS LIST ARE NOT TO SCALE

	PARTS LIST	DESCRIPTION	ORDER PART #	QTY		PARTS LIST	DESCRIPTION	ORDER PART #	QTY
A		SEAT FRAME	AN0523	1	F		BOLT COVER	HW0022	2
B		SEAT BASE	AN0524	1	G		HEX BOLT DRIVER	HW0252	1
C		1/4" X 35 MM BOLT	HW0142	2			FOOT CAP FACTORY ASSEMBLY	FC0030	
D		1/4" X 45 MM BOLT	HW0040	2			SLING TUBE CAP FACTORY ASSEMBLY	FC0358	
E		Ø6.5 X 1.0 MM WASHER	HW0004	2					

ADS17500

**IMPORTANT!! PLEASE READ ENTIRE INSTRUCTION SHEET BEFORE ASSEMBLY!!
TO EXPEDITE ANY FUTURE WARRANTY CLAIMS, PLEASE KEEP INSTRUCTION SHEET, WARRANTY CARD AND RECEIPT**

Step 1: Identify all parts packed in carton against the parts list. Remove all protective materials. Place parts on a non-abrasive surface to avoid scratching. If you are missing any parts or are unsure as how to proceed with the assembly, call our Customer Service Center at 1-800-416-3511. **Do not attempt assembly if any parts are missing or damaged.**

Step 2: Place the swivel base (with rocker assembly) on a flat, solid surface. Make sure the rocker assembly is positioned all the way into the base. It may have shifted or vibrated out during shipment.

Step 3: Important: We recommend 2 people work together to assemble the chair. Note the arrow labels on the "U" bar and the rocker assembly. Also note the horseshoe shape of the rocker plate. Point the open end of the horseshoe away from you. The arrows on the rocker assembly should be pointing towards you. Set the chair frame on the rocker assembly with front of the seat facing you and the arrows on the "U" bar pointing towards you as shown in *Figure 1*. This is very important for a safe, balanced rocking motion. **If chair frame has been properly positioned on the rocker assembly, all arrows on the "U" bar and rocker assembly will be pointing in the same direction.**

Step 4: Critical Step: The "U" metal plates must be installed in the proper location. Read this step and carefully examine. Insert the "U" metal plate, so that the "U" bar and rocker plate are between both sides of the "U" metal plate. Make sure that the holes in the "U" metal plate are completely aligned with the holes in the "U" bar as shown in *Figure 1*. Guide the bolts through the holes on the top side of the "U" metal plate, through the holes in the "U" bar portion of the chair, through the holes in the rocker plate and then, most importantly, through the holes in the bottom side of the "U" metal plate. It is very important that the holes in the bottom portion of the "U" metal plate be placed directly beneath the holes in the rocker plate. Add a spring washer and a nut to each bolt as shown in *Figure 2*. **Hand tighten nuts 3-4 revolutions only.** Repeat the same procedure on the other side.

CAUTION: Failure to place "U" metal plates under the rocker plates and above the "U" bar exactly as shown in diagram will cause the bolt heads and nuts to damage the structure of the rocker plates and the "U" bar. Damage due to over tightening of bolts or improper assembly could cause injury and may void your warranty.

Step 5: Tighten all nuts and bolts with the hex wrenches provided. **Do not over tighten.** Remove arrow labels from "U" bar and rocker assembly. Cover bolts with bolt covers.

Step 6: Your chair should be ready for use. If your chair is not rocking properly, double-check your assembly procedure, especially Step 3. If the chair rocks too far forward to or is difficult to rock backwards, you have probably installed the seat frame backwards on the rocker assembly. If you need further assistance, please call our Customer Service Center at 1-800-416-3511.

IMPORTANT NOTE: Damage to welds or frames resulting from over tightened bolts or improper assembly is not covered under our warranty. Please read all instructions carefully before assembly. If you have any questions regarding your assembly, call our Customer Service Center at 1-800-416-3511.

NOTE: MAKE SURE ARROWS FROM BOTH THE "U" BAR AND ROCKER ASSEMBLY ARE POINTING IN THE SAME DIRECTION!

SEAT DESIGNS MAY VARY BUT THE ASSEMBLY IS THE SAME

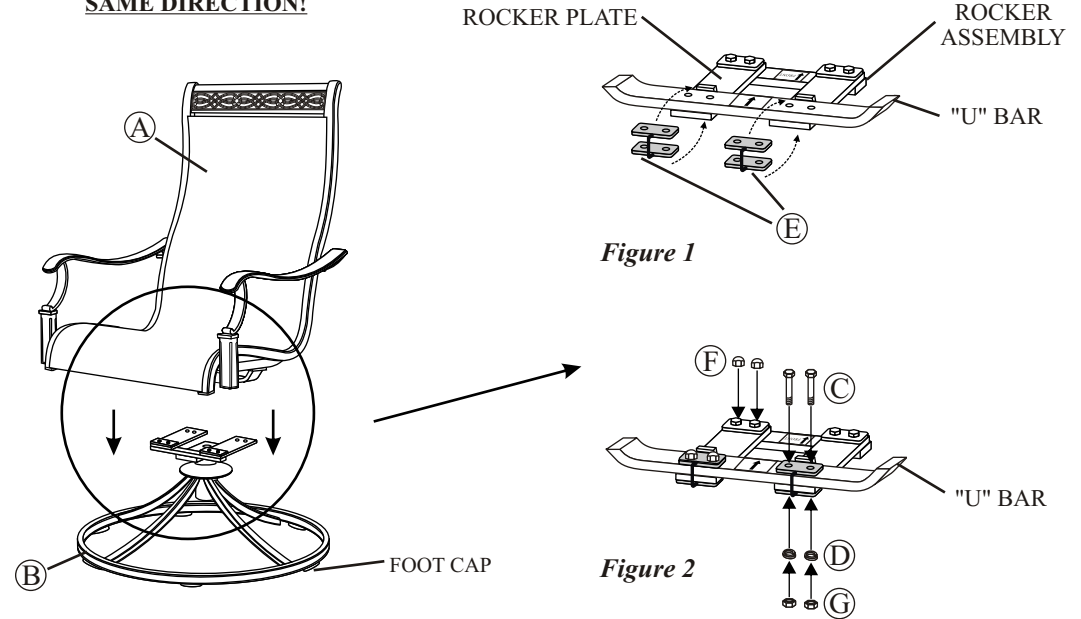

* NOTE: PARTS SHOWN ON PARTS LIST ARE NOT TO SCALE

	PARTS LIST	DESCRIPTION	ORDER PART #	QTY		PARTS LIST	DESCRIPTION	ORDER PART #	QTY
A		CHAIR FRAME	AR19238	1			HEX WRENCH-1	HW0008	1
B		SWIVEL BASE & ROCKER ASSEMBLY	AR19239	1			HEX WRENCH-2	HW0007	1
C		5/16" X 40 MM BOLT	HW0295	4			ROCKER PLATE FACTORY ASSEMBLY	HW0619	
D		Ø8.0 X 2.3 MM SPRING WASHER	HW0003	4			FOOT CAP FACTORY ASSEMBLY	FC0359	
E		"U" METAL PLATE	HW0618	2			SLING TUBE CAP FACTORY ASSEMBLY	FC0358	
F		BOLT COVER	HW0028	8					
G		5/16" NUT	HW0015	4					

ADS17501