

Collection: COSMOS (NEBULA)

Product #: CHB0069-03

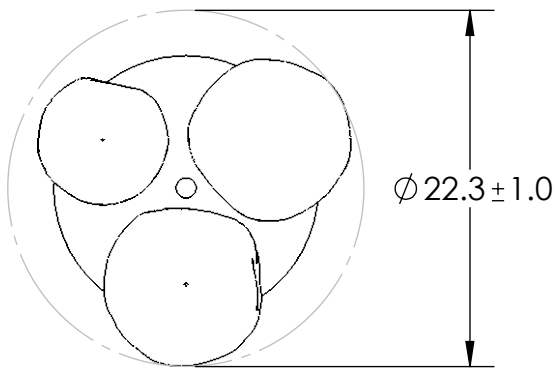
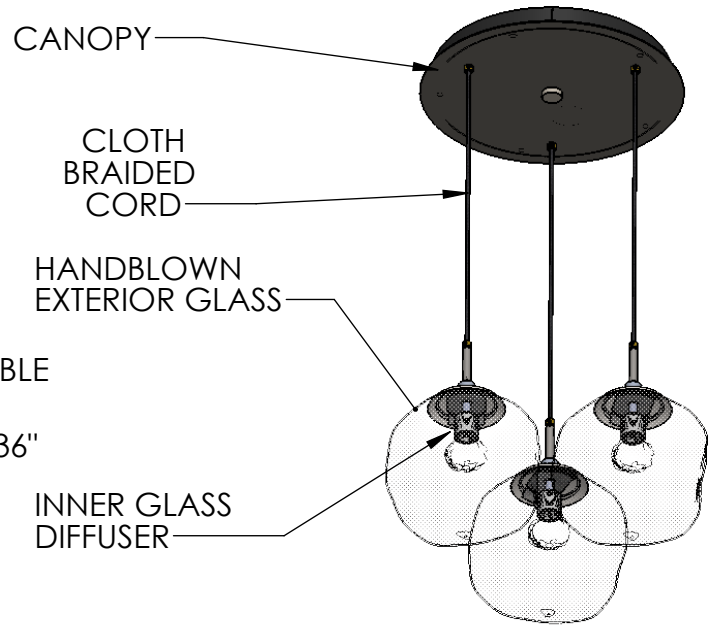
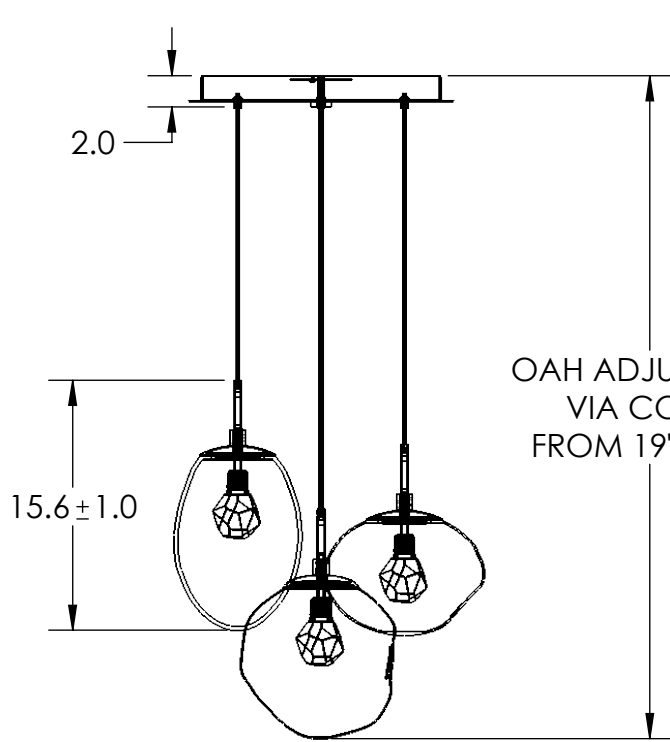

GLASS OPTIONS

Exterior Glass may vary ± 1"

INTERNAL GLASS



ZIRCON



GEO



FLORET

EXTERIOR GLASS

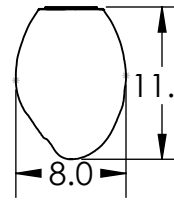

METEO

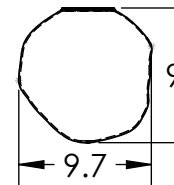

ASTER

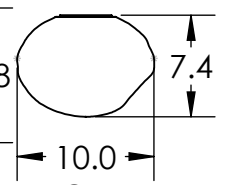

NOVA

All dimensions are shown in inches unless otherwise stated.
Visit hammertonstudio.com for product options and specifications.

2/21/2020 (A)

Mounting Packet: W	Weight(lbs.): 33	Electrical Type: LED	CCT: 2700 K
UL Location: DRY	Elec. Qty: 3	Wattage: 16	Voltage: 120
Finish: SEE WEBSITE FOR OPTIONS	Source Lumens:	Ambient: 1020	Down: 0
Top Diffuser: N/A	Dimmable: Forward/Reverse Phase To 1%		
Bottom Diffuser: CLOSED GLASS	CRI: 93+	Power Factor: >0.9	

Canopy Mounting Detail

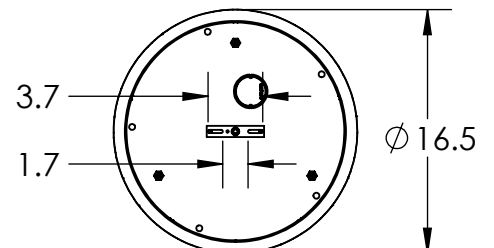

MOUNTS DIRECTLY TO J-BOX