

Collection: GLACIER

Product #: CHB0060-09

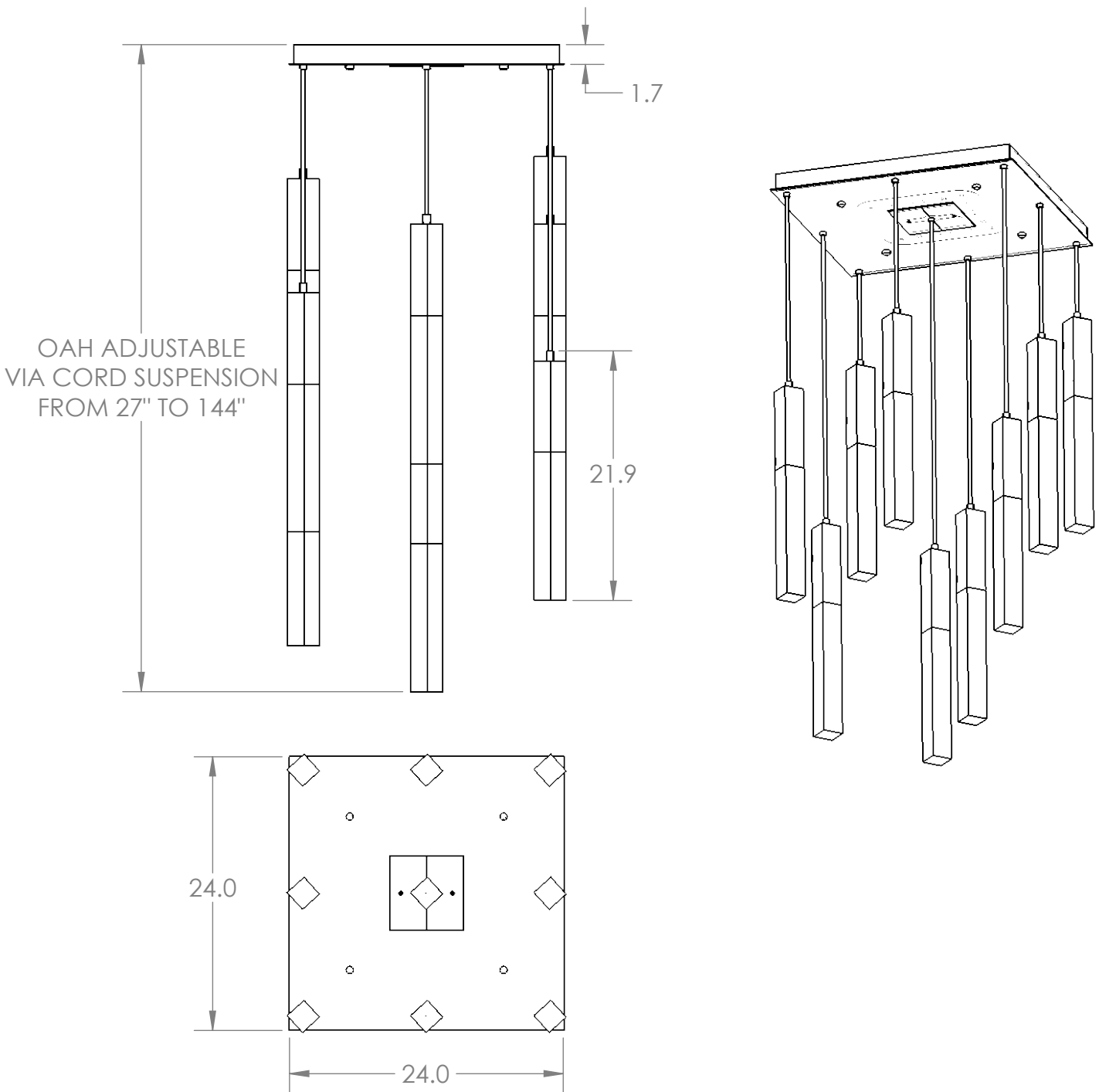

Visit hammertonstudio.com for product options and specifications.

12/11/2018 (A)

Mounting Packet: R	Weight(lbs.): 96	Electrical Type: LED	CCT: 2700 K
UL Location: DRY	Elec. Qty: 9	Wattage: 35	Voltage: 120
Finish: SEE WEB SITE FOR OPTIONS	Source Lumens: Up: 0	Down: 3080	
Top Diffuser: CLOSED METAL	Dimmable: Forward/Reverse Phase To 1%		
Bottom Diffuser: CLOSED GLASS	CRI: 93+	Power Factor: >0.9	

Mounting Detail

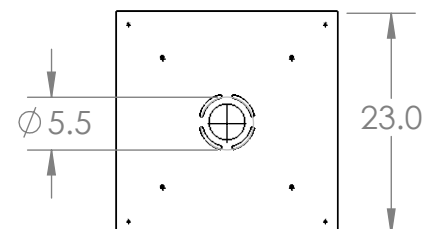

All fixtures created by Hammerton are handcrafted by artisans. Dimensions may vary up to 7/8".
 © Copyright 2018. All rights in design, detail or invention of this drawing are reserved as the property of Hammerton. Any imitation or adaptation without written consent is strictly prohibited.