

Collection: DOWNTOWN

Product #: CHB0020-48

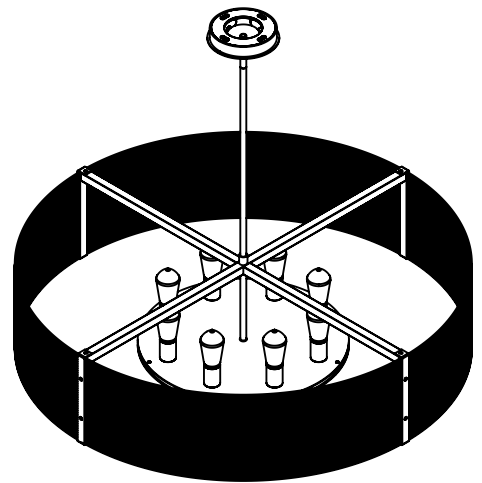

NO LENS, EXPOSED LAMPING

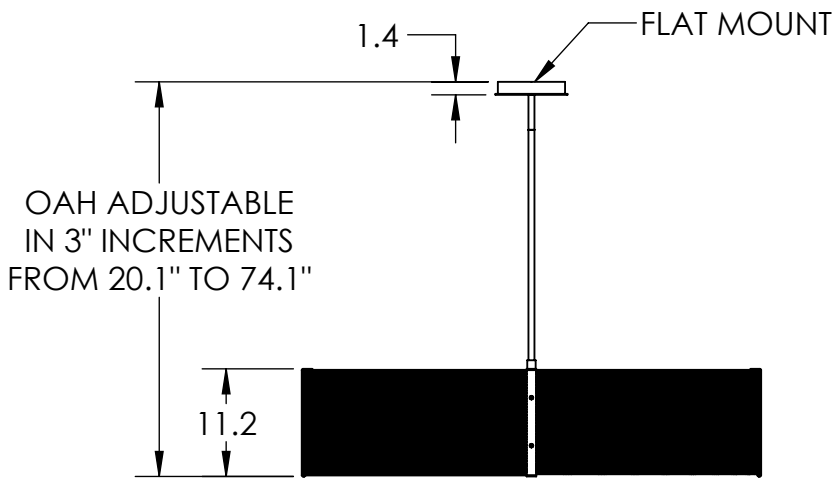
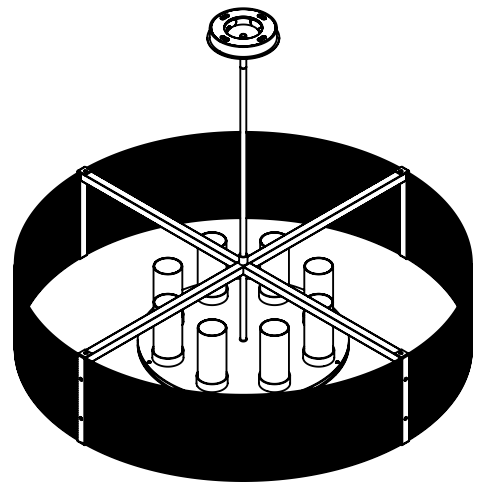
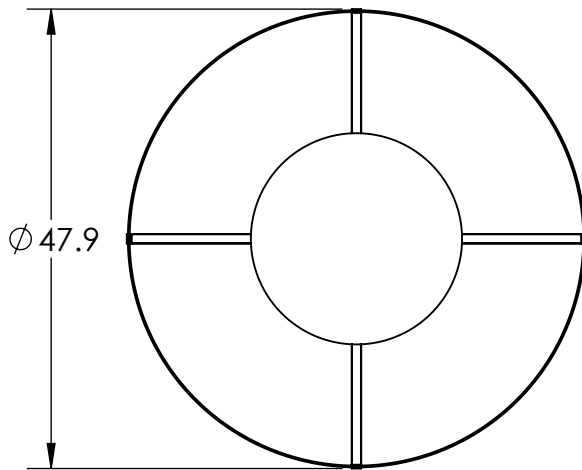

FROSTED GLASS

ELECTRICAL OPTIONS

Product #	Electrical Type	Bulb Type	Wattage	Socket Type
CHB0020-48-XX-X-XXX-E2	Incandescent	B11	60	Medium E26
CHB0020-48-XX-X-XXX-G2	Flourescent	CFL/LED RETRO	13	GU-24

Bulbs Not Included Visit hammertonstudio.com for product options and specifications.

4/4/2016 ©

Mounting Packet: S	Electrical Type: SEE TABLE
Approximate lbs.: 60	Bulb Qty: 8 Bulb Type: SEE TABLE
Finish: SEE WEB SITE FOR OPTIONS	Wattage: SEE TABLE Voltage: 120
Top Diffuser: OPEN	Socket Type: SEE TABLE
Bottom Diffuser: OPEN	UL Location: DRY

Mounting Detail

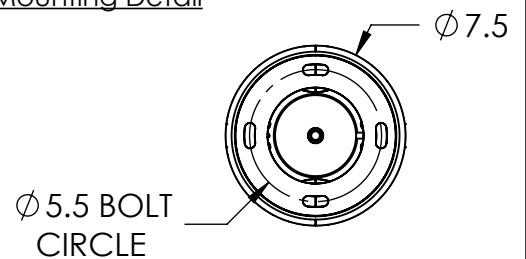

MOUNTS TO BUILDING STRUCTURE

All fixtures created by Hammerton are handcrafted by artisans. Dimensions may vary up to 7/8".

© Copyright 2016. All rights in design, detail or invention of this drawing are reserved as the property of Hammerton. Any imitation or adaptation without written consent is strictly prohibited.

Hammerton Inc. 217 Wright Brothers Dr. Salt Lake City, UT 84116 (801)973-8095