

DESCRIPTION

H38LVICAT is an IC AIR-TITE™ fixture for use with H3 3" series trims. Housing is AIR-TITE rated to prevent airflow between heated or air conditioned spaces and unconditioned attic areas. For use with 12V MR16 lamps.

H38LVICAT is IC rated and may be used in insulated ceilings and be covered with insulation material.

Catalog #		Type
Project		
Comments		Date
Prepared by		

SPECIFICATION FEATURES

Housing

IC and AIR-TITE rated double wall aluminum construction.

Plaster Frame

Housing adjusts in plaster frame to accommodate up to 1-1/2" ceiling thickness. Galvanized steel construction.

Plaster frame features include:

- Regressed locking screw for securing hanger bars.
- Cutouts for easily crimping hanger bars in position.
- HALO name embossed on plaster frame.
- The inner can housing may be removed from the plaster frame to provide access to the junction box.
- Pre-installed AIR-TITE gasket.

Got NAIL!™ Bar Hangers

- Pre-installed nail easily installs in regular lumber, engineered lumber and laminated beams.
- Safety and guidance system prevents snagging, ensures smooth straight nail penetration and allows bar hangers to be easily removed if necessary.
- Automatic levelling flange aligns the housing and lets you hold the housing in place with one hand while driving nails.

- Housing can be positioned at any point within 24" joist span
- Pass-N-Thru™ feature allows bar hangers to be shortened without removing from plaster frame.
- Score lines allow "tooless" shortening for 12" joists.
- Bar hangers may be repositioned 90°.
- Integral T-bar clip snaps onto T-bars - no additional clips required.

Junction Box

- UL Listed for through branch circuit wiring (4 No. 12ga., 90°C conductors).
- Four 1/2" trade size conduit knockouts with true pry-out slots are positioned to accommodate straight conduit runs.
- Three Slide-N-Side™ wire traps allow non-metallic sheathed cable to be installed without tools and without removing knockouts. Accepts a wide range of non-metallic sheathed cable.
 - Allows wiring connections to be made outside the junction box
 - Simply insert the cable directly into the trap after connections are made.
 - Three push-in wire connectors are included and eliminate the need for separate wire nuts.

- Accommodates the following standard non-metallic sheathed cable sizes:
(US) #14/2, #14/3, #12/2, #12/3
(Canada) #14/2, #14/3, #12/2

Transformer

Integral magnetic transformer steps 120V line voltage down to 12V lamp operating voltage.

Socket

GU5.3 socket for 12V MR16 lamps.

Labels

- UL/cUL Listed 1598 Luminaire
 - UL/cUL Damp Location Listed
 - UL/cUL Listed for Feed Through
 - UL/cUL Listed for Direct Contact with Insulation and combustible material
- Meets following IC - AIR-TITE requirements:
- State of California Title 24
 - Washington State Energy Code
 - International Energy Conservation Code (IECC)
 - New York State Energy Conservation Construction Code
 - Certified Under ASTM-E283 for air tight construction.

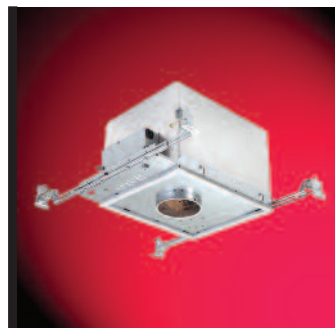

H38LVICAT

**3" Insulated Ceiling
AIR-TITE™ Recessed
Housing
12V MR16**

3" TRIMS

FOR USE IN
INSULATED CEILINGS

CAN BE COVERED WITH
INSULATION



12V MR16

Transformer Data:

Type: Magnetic
Primary: 120VAC, 60 Hz
Secondary: 11.5 ±0.3V



Features

- Slide-N-Side™ Junction Box
- GOT NAIL!™ Bar Hangers
- Pass-N-Thru™ Bar Hangers
- Regressed Locking Screw
- HALO ID on Plaster Frame

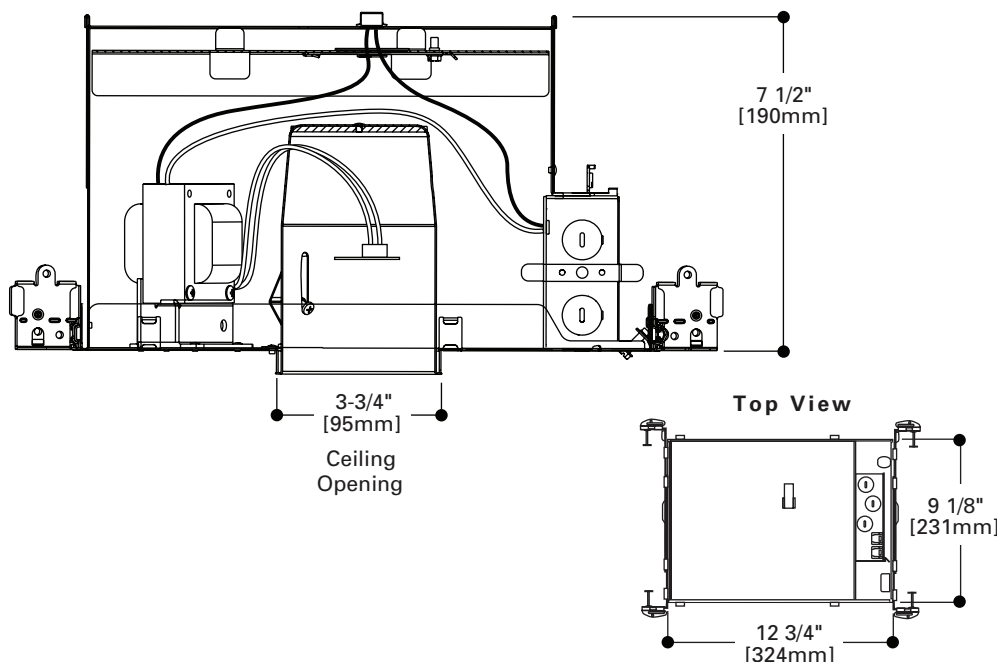

Specifications and dimensions subject to change without notice.
 Consult your representative for additional options and finishes.

ORDERING INFORMATION

SAMPLE NUMBER: H38LVICAT-3001WHBB

Order housing and trims separately.

Housing

Trims

H38LVICAT

H38LVICAT=3" AIR-TITE™
IC Small Aperture
Low Voltage
MR16 Housing

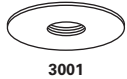

Adjustable Pinhole Baffle - 15° Tilt
37W 12V MR16
3001WHBB=White with Black Baffle
3001BKBB=Black with Black Baffle
3001SNBB=Satin Nickel with Black Baffle
3001ACBB=Antique Copper with Black Baffle
3001TBZBB=Tuscan Bronze with Black Baffle
OD: 4-1/4" [108mm]

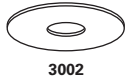

Adjustable Pinhole Reflector- 15° Tilt
37W 12V MR16
3002WHC=White with Clear Reflector
3002BKC=Black with Clear Reflector
3002SNC=Satin Nickel with Clear Reflector
3002ACC=Antique Copper with Clear Reflector
3002TBZC=Tuscan Bronze with Clear Reflector
OD: 4-1/4" [108mm]

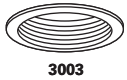

Adjustable Baffle- 35° Tilt
50W 12V MR16
3003WHBB=White with Black Baffle
3003WHWB=White with White Baffle
3003BKBB=Black with Black Baffle
3003SNB=Satin Nickel with Satin Nickel Baffle
3003ACB=Antique Copper with Antique Copper Baffle
3003TBZB=Tuscan Bronze with Tuscan Bronze Baffle
OD: 4-1/4" [108mm]



Adjustable Reflector- 35° Tilt
50W 12V MR16
3004WHC=White with Clear Reflector
3004BKC=Black with Clear Reflector
3004SN=Satin Nickel with Satin Nickel Reflector
3004AC=Antique Copper with Antique Copper Reflector
3004TBZ=Tuscan Bronze with Tuscan Bronze Reflector
3004WHH=White with Haze Reflector
3004WHW=White with White Reflector
OD: 4-1/4" [108mm]



Crossblade Reflector
50W 12V MR16
3005WHC=White with Clear Reflector
3005BKC=Black with Clear Reflector
OD: 4-1/4" [108mm]

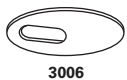

Adjustable Slot Aperture- 35° Tilt
37W 12V MR16
3006WHBB=White with Black Baffle
3006BKBB=Black with Black Baffle
3006SNBB=Satin Nickel with Black Baffle
3006ACBB=Antique Copper with Black Baffle
3006TBZBB=Tuscan Bronze with Black Baffle
OD: 4-1/4" [108mm]



Regressed Lens Showerlight- 15° Tilt - Wet Location Listed
37W 12V MR16
3007WHC=White with Clear Reflector
3007PCC=Polished Chrome with Clear Reflector
3007SN=Satin Nickel with Satin Nickel Reflector
3007AC=Antique Copper with Antique Copper Reflector
3007TBZ=Tuscan Bronze with Tuscan Bronze Reflector
OD: 4-1/4" [108mm]

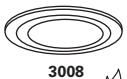

Showerlight - Wet Location Listed
37W 12V MR16
3008FG=White Polymer and Glass Lens with Frosted Perimeter
OD: 4-1/4" [108mm]



Adjustable Gimbal- 35° Tilt
50W 12V MR16
3009WHBB=White with Black Baffle
3009WHWB=White with White Baffle
3009BKBB=Black with Black Baffle
3009SNBB=Satin Nickel with Black Baffle
3009ACBB=Antique Copper with Black Baffle
3009TBZBB=Tuscan Bronze with Black Baffle
OD: 4-1/4" [108mm]



Super Adjustable- 0 - 80° Adjustment
50W 12V MR16
3010WH=White
3010SN=Satin Nickel
3010TBZ=Tuscan Bronze
OD: 4-1/4" [108mm]



Square Adjustable - 15° Tilt
37W 12V MR16
3011WHBB=White with Black Baffle
3011WHWB=White with White Baffle
3011BKBB=Black with Black Baffle
3011SNBB=Satin Nickel with Black Baffle
3011ACBB=Antique Copper with Black Baffle
3011TBZBB=Tuscan Bronze with Black Baffle
OD: 4-1/4" [108mm]



Square Regressed Lens Adjustable Showerlight - 15° Tilt
37W 12V MR16
3012WHBB=White with Black Baffle
3012WHWB=White with White Baffle
3012BKBB=Black with Black Baffle
3012SNBB=Satin Nickel with Black Baffle
3012ACBB=Antique Copper with Black Baffle
3012TBZBB=Tuscan Bronze with Black Baffle
OD: 4-1/4" [108mm]



Square Adjustable Gimbal - 35° Tilt
37W 12V MR16
3013WH=White
3013BK=Black
3013SN=Satin
3013AC=Antique Copper
3013TBZ=Tuscan Bronze
OD: 4-1/4" [108mm]



Glass Cylinder - Frost Glass with Optional Blue Glass Included
50W 12V MR16
3014FBWH=Frost/Blue Glass Cylinder with White Trim
3014FBSC=Frost/Blue Glass Cylinder with Satin Chrome Trim
OD: 4-1/4" [108mm]



Low Profile Glass Curve
50W 12V MR16
3016FG=Frost Glass Curve
3016BG=Blue Glass Curve
3016AG=Amber Glass Curve
OD: 4-1/4" [108mm]



All-Glass Frost Curve Showerlight - Wet Location Listed
50W 12V MR16
3017FGS=All-Glass Frost Curve with Clear Glass Center - Showerlight
OD: 4-1/4" [108mm]

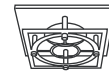

Square Drop Glass
37W 12V MR16
3018SGSC=Square Designer Drop Glass with Satin Chrome Trim
OD: 4-1/4" [108mm]



Round Drop Glass
37W 12V MR16
3019RGSC=Round Designer Drop Glass with Satin Chrome Trim
OD: 4-1/4" [108mm]

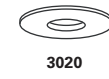

Wall Wash
37W 12V MR16
3020WW=White Downlight & Wall Wash with Integral Kick Reflector
OD: 4-1/4" [108mm]