

For use on doors 1-3/8" to 2" (35 mm - 51 mm) thick

- |   |  |
|---|--|
| <p><b>TOOLS REQUIRED FOR NEW INSTALLATION:</b></p> <ul style="list-style-type: none"> <li>(1) Phillips Head Screwdriver</li> <li>(1) 2-1/8" (54 mm) Hole Saw</li> <li>(1) 1" (25.4 mm) Drill Bit</li> <li>(1) 5/16" (8 mm) Drill Bit</li> <li>(1) Chisel</li> <li>(1) Catch-Release Tool (Provided)</li> </ul> <p><b>TOOLS REQUIRED FOR REPLACEMENT INSTALLATION:</b></p> <ul style="list-style-type: none"> <li>(1) Phillips Head Screwdriver</li> </ul> | <p><b>FOR REMODELING OR NEW CONSTRUCTION:</b></p> <ul style="list-style-type: none"> <li>-Follow all steps</li> </ul> <p><b>FOR REPLACEMENT OF EXISTING LOCK:</b></p> <ul style="list-style-type: none"> <li>-Follow steps 3C, 4C, 5 through 9 after removal of old lock</li> </ul> <p><b>FOR CYLINDER REPLACEMENT:</b></p> <ul style="list-style-type: none"> <li>-Follow Step 10</li> </ul> <p><b>NOTE:</b></p> <ul style="list-style-type: none"> <li>Failure to install thru-bolts and removable screw posts voids BHMA certification, UL rating, and warranty.</li> </ul> |
|---|--|

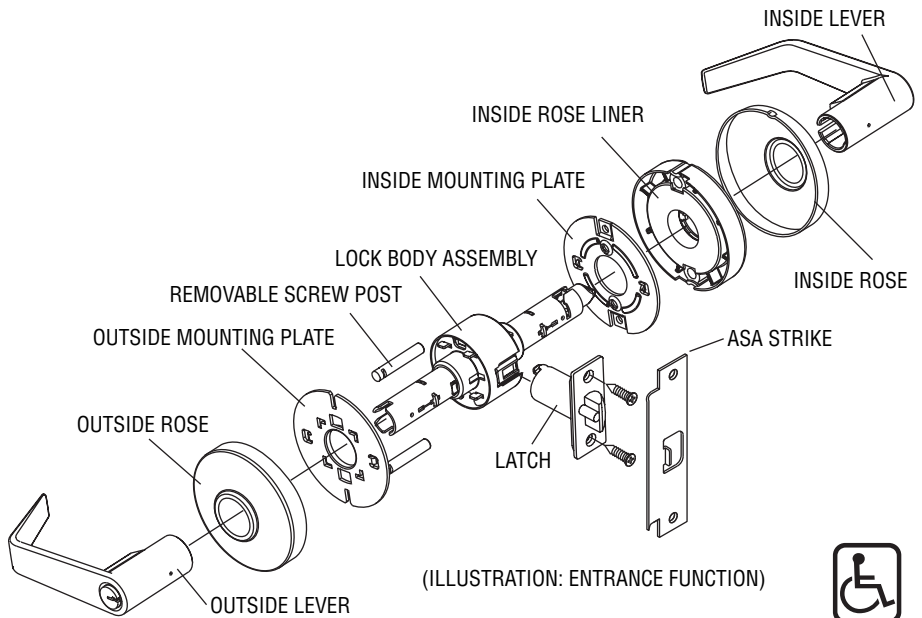

**1. MARK DOOR**

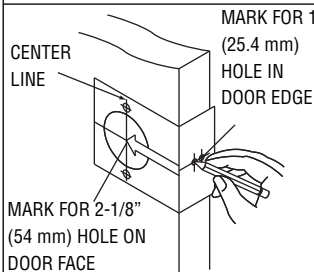

Measure center line of lock; height as desired from finished floor. Select 2-3/4" or optional 2-3/8" backset, fold and apply template to high side of door bevel and mark center of door edge as indicated on template. Mark center hole and screw-post holes on door face through guide on template.

**2. DRILL HOLES**

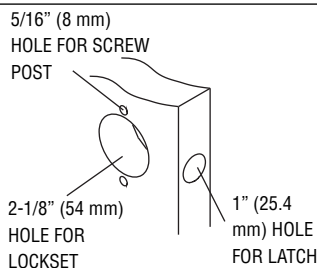

Drill 2-1/8" (54 mm) hole through door face as marked for lockset. (It is recommended that holes be drilled from both sides on wood doors to prevent splitting.) Drill 5/16" (8 mm) holes for screw-posts. Drill 1" (25.4 mm) hole in center of door edge for latch.

**3. INSTALL LATCH**

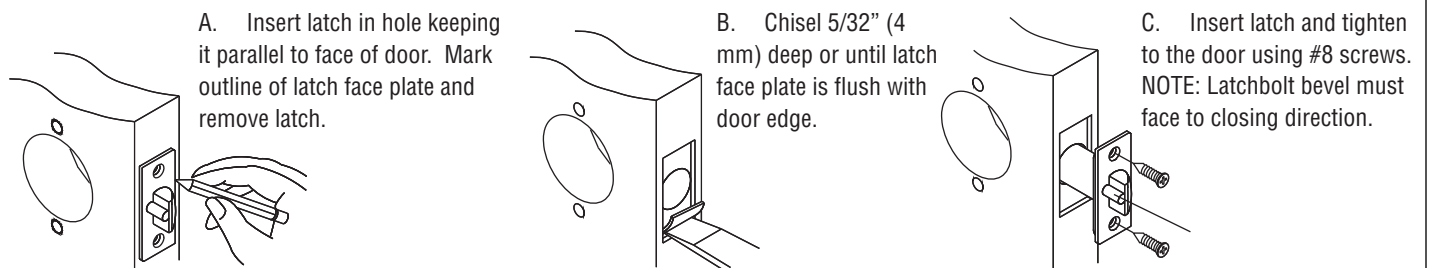

**4. INSTALL STRIKE**

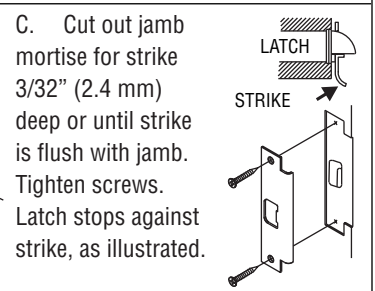
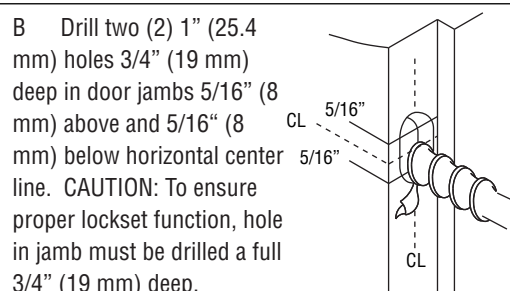
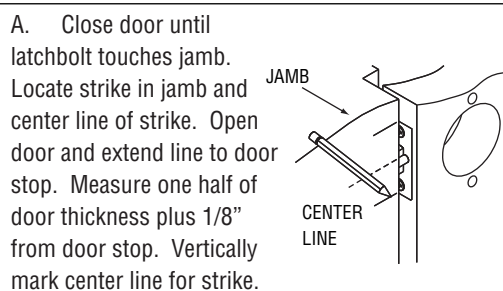

**5. REMOVE INSIDE TRIM**

Use catch release tool to depress lever catch visible under hole of inside lever shank and slide off inside lever, rose, rose liner, and mounting plate.

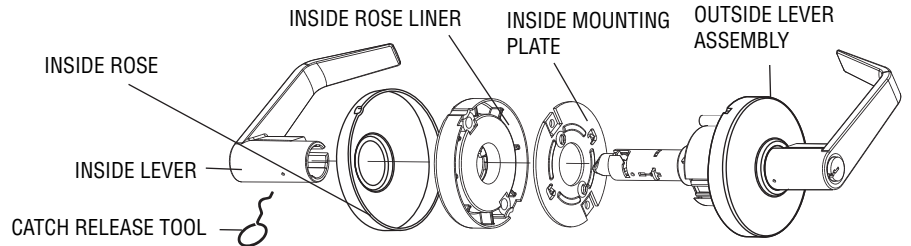

**6. ADJUST DOOR THICKNESS**

A. Outside mounting plate is pre-set for 1-3/4" door thickness. To fit different door thicknesses, remove outside lever, rose, and rose liner. Now adjust the outside mounting plate by rotating plate until tip of catch release tool lines up with desired door thickness indicated on lock body assembly.

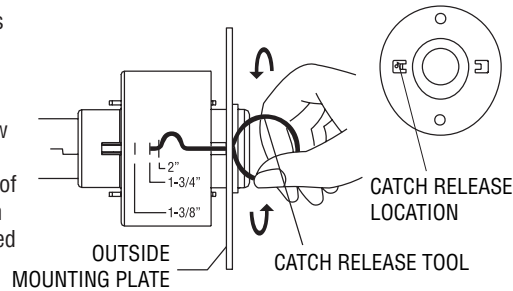

B. Install removable screw post into slots on outside mounting plate. Install rose liner and align rose liner arrow in the direction of the lock stile. Install outside rose and lever onto lock body assembly.

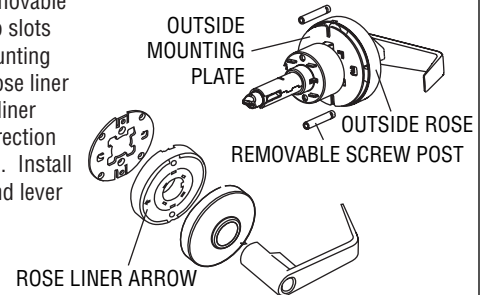

**7. INSTALL OUTSIDE LEVER ASSEMBLY**

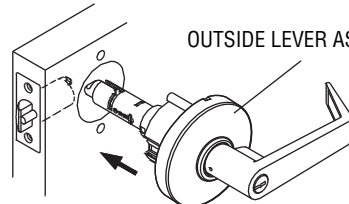
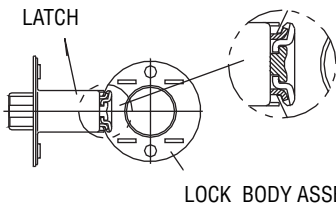

Install outside lever assembly on the door. Make sure tail of latch engages with retractor correctly as illustrated.

**8. INSTALL INSIDE MOUNTING PLATE AND ROSE LINER**

A. Install mounting plate tight to door face and tighten screws securely to the lockbody using interior mounting holes.

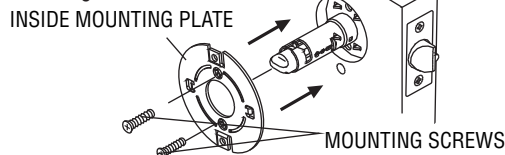

B. Install inside rose liner and align rose liner arrow in the direction of the lock stile. Tighten rose liner to the thru posts using mounting screws.

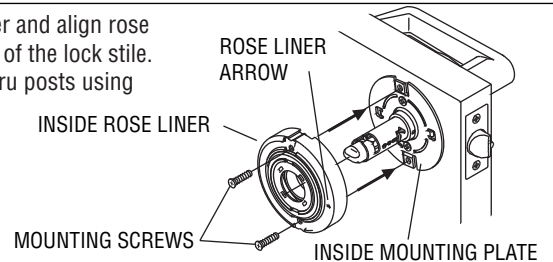

**9. INSTALL INSIDE ROSE AND LEVER**

A. Align indent on inside rose with groove on inside rose liner. Press inside rose onto inside rose liner and rotate clockwise to fully seat inside rose.

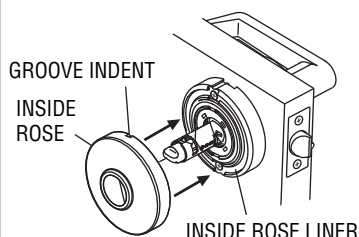

B. Push lever all the way in until it clicks into catch hole.

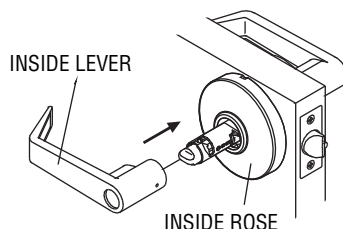

**10. REPLACE CYLINDER (SKIP THIS STEP IF INSTALLING 3510 OR 3540)**

A. Turn key clockwise 1/4 turn.

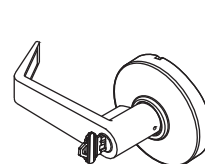

B. Using catch release tool, press the lever catch and pull the lever off.

