

1

EKU Divido 100 H

- Maximum door weight: 100 kg (220 lbs.)
- Maximum door height: 2400 mm (7' 10 1/2")
- Maximum door width: 1200 mm (3' 11 1/4")
- Door thickness, wood: 30 mm (1 3/16")
- Height adjustability: +/- 3 mm (1/8")
- Suitable for 1 – 4 sliding doors
- Available with anodized aluminum fascias or clip components for attaching wood fascias
- Allows for wood and glass sliding door combinations
- Single upper running track can be ceiling or wall mounted

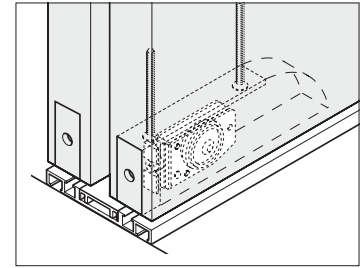

For door widths greater than 900 mm (35 7/16") it is recommended to use an additional lower guide. Refer to Page 1.66-1.67 for detail.

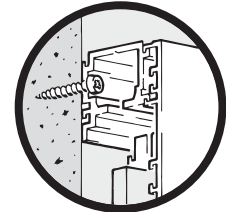
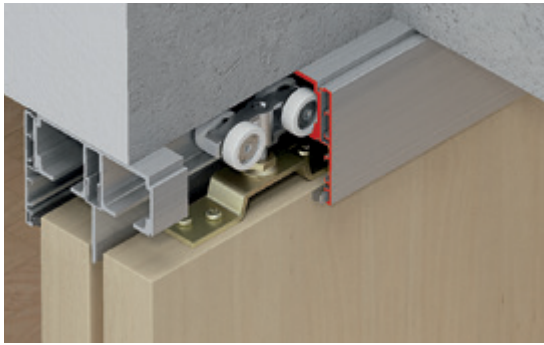

Wall mounted

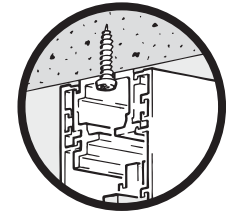

Ceiling mounted

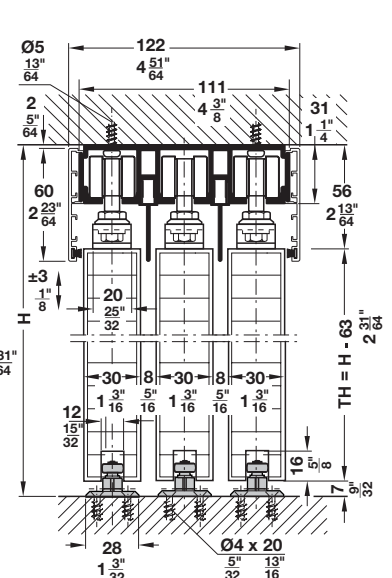
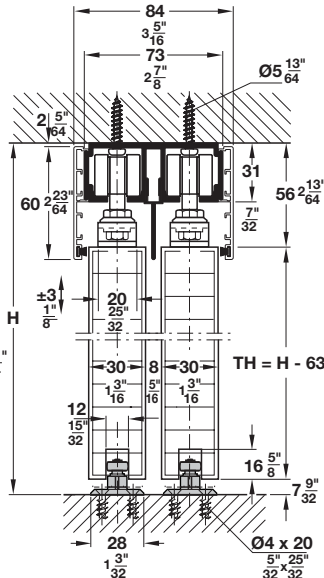
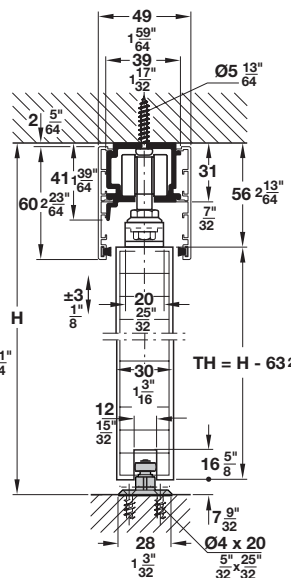
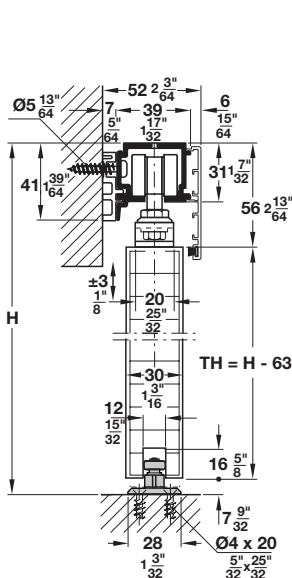
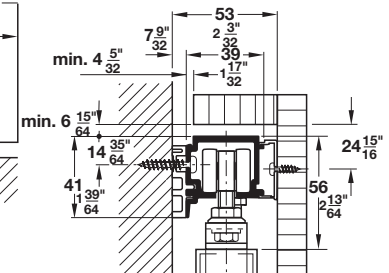
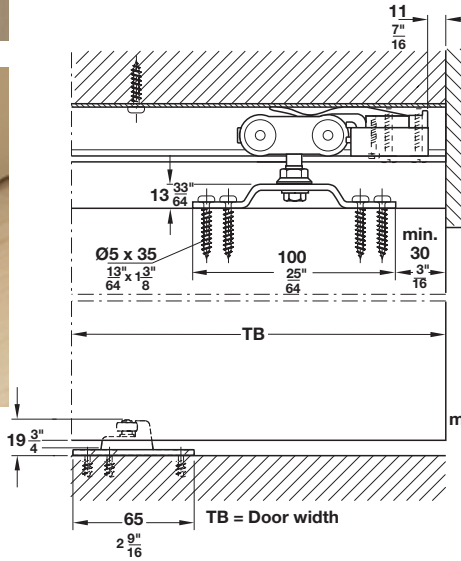

Dimensions in mm
Inches are approximate

TH = Door height







Dimensional data not binding. We reserve the right to alter specifications without notice.

EKU Divido 100 H Set













- For 1 sliding door without the upper running tracks

	Item No.
	941.00.111

Set Components

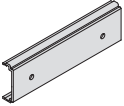
	Description	Material	Color/Finish	Qty.
	Running gear, with four wheels	Plastic	white	2 pcs.
	Suspension bolt, M8 x 32 mm	Steel	zinc-plated	2 pcs.
	Set nut, M8	Steel	zinc-plated	2 pcs.
	Suspension plate	Steel	zinc-plated	2 pcs.
	Door stopper with adjustable retention spring	Plastic	gray	2 pcs.
	Lower guide	Plastic	anthracite gray	1 pc.
	Fixing screws	-	-	-

Individual Components

	Description	Material	Color/Finish	Length	Item No.
	Single upper running track, 39 x 41 (1 9/16" x 1 5/8")	Aluminum	unanodized	2.5 m (8' 2 7/16")	941.00.253
				3.5 m (11' 5 13/16")	941.00.353
				6 m (19' 8 1/4")	941.00.603
	Dual upper running track, 73 x 31 (2 7/8" x 1 1/4")	Aluminum	unanodized	2.5 m (8' 2 7/16")	941.12.925
				3.5 m (11' 5 13/16")	941.12.935
				6 m (19' 8 1/4")	941.12.960
	Triple upper running track 111 x 31 (4 3/8" x 1 1/4")	-	-	2.5 m (8' 2 7/16")	941.13.425
				3.5 m (11' 5 13/16")	941.13.435
				6 m (19' 8 1/4")	941.13.460
	Spacer profile for wall mounting of single upper running track 11 x 36 (7/16" x 1 7/16")	Plastic	gray	2 m (6' 6 3/4")	941.13.220
	Clip-in skirt, 10 x 42 (3/8" x 1 11/16")	Aluminum	anodized	2.5 m (8' 2 7/16")	941.12.325
				3.5 m (11' 5 13/16")	941.12.335
				6 m (19' 8 1/4")	941.12.360
	Clip-on fascia to upper running track, 7 x 60 (5/16" x 2 3/8")	Aluminum	anodized	2.5 m (8' 2 7/16")	941.12.425
				3.5 m (11' 5 13/16")	941.12.435
				6 m (19' 8 1/4")	941.12.460
	Brush seal for clip-on fascia, 5 x 5 (3/16" x 3/16")	Plastic	gray	10 m (32' 9 11/16")	405.80.500
	End piece to fascia, one-sided, wall mounted, 51 x 60 (2" x 2 3/8")	Aluminum	anodized	-	941.12.060
	Clip piece for wood fascia, 97 x 29 x 9.5, mounted every 500 mm (19 11/16")	Aluminum	unanodized	-	940.60.065
	Soft closer	10 - 60 kg (22 - 132 lbs.)		940.60.045	
		61 - 100 kg (133 - 200 lbs.)		940.60.010	
	Cover cap, for soft closer			940.60.094	
	Milling jig, for soft closer			940.60.095	

Dimensional data not binding. We reserve the right to alter specifications without notice.

Dimensions in mm
Inches are approximate