

Top Hung System

EKU-Porta 100/G

- For 1 and 2 sliding glass doors
- Smooth quiet operation
- Maintenance-free
- Rattle-free bottom guide
- Simple installation
- No glass cut-outs required
- Vertical adjustment without removing the glass door

- Maximum door weight: **100 kg** (220 lbs.)
- For glass thickness: **6 - 12.7 mm** (1/4" - 1/2")

Installation Tips

When using 2 sliding doors on the same track, please make sure that glass panels do not collide. Please use a lower guide channel with a door stopper or use protective edge trim.

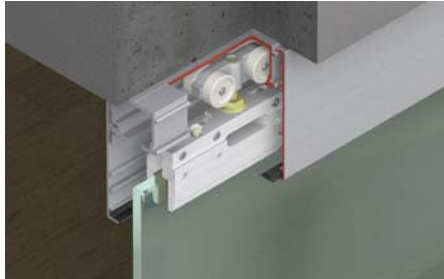

Wall Mounted

Ceiling Mounted

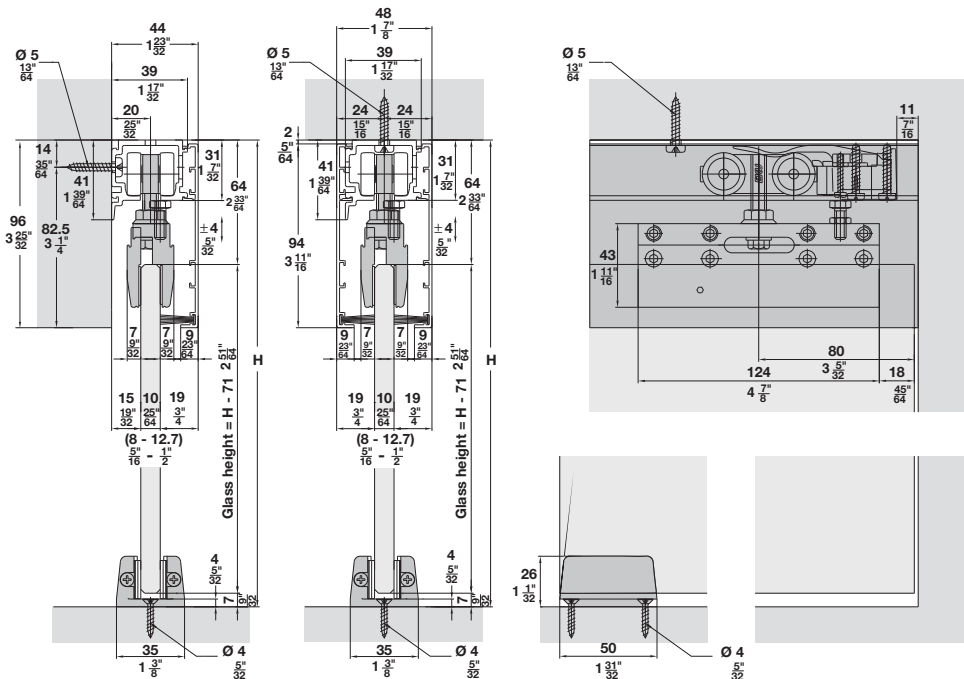

Dimensions in mm are exact
Inches are approximate

Top Hung System

EKU-Porta 100/G

Fitting Sets

1 set				941.00.007
Consisting of:	Description	Material/Finish/Color	Packing	Item No.
	Double roller running gear		2 pcs.	941.00.012
	Suspension bolt, M8 x 35	steel, zinc-plated	2 pcs.	940.60.021
	Set nut, M8	steel, zinc-plated	2 pcs.	940.60.022
	Clamp shoe adjustable from 6 - 12.7 mm (1/4" - 1/2")	aluminum, mill finish	2 pcs.	941.00.020
	Track stopper, with adjustable retention spring	plastic, gray	1 pc.	940.60.043
	Track stopper	plastic gray	1 pc.	940.60.041
	Floor guide, adjustable from 6 - 12.7 mm (1/4" - 1/2")		1 pc.	941.00.031
	Buffer	rubber, black	1 pc.	940.60.051

Note:

- Item numbers are valid for only 1 piece, when ordering individual components please state the desired amount
- For 2 bi-parting sliding glass doors please order 2 sets

Upper Tracks, pre-drilled, 41 x 39 mm (1 39/64" x 1 17/32")

Description	Material	Item No.
2.5 m (8' 2 7/16")	aluminum, unanodized	941.00.253
6.0 m (19' 8 1/4")	aluminum, unanodized	941.00.603

Packing: 1 pc.

Clip-on Fascia to upper track, 94.5 x 9 mm (3 23/32" x 23/64")

Description	Material	Item No.
2.5 m (8' 2 7/16")	aluminum, anodized	941.00.825
6.0 m (19' 8 1/4")	aluminum, anodized	941.00.860

Packing: 1 pc.

Components

Description	Material/Color	Packing	Item No.
	aluminum, anodized	1 set	941.00.066
	aluminum, anodized	1 set	941.00.070
	aluminum, unanodized	1 pc.	941.00.065
	plastic, black	1 roll	941.00.094

Installation Plan: (included in fitting set), mounting instructions for planning and execution are available upon request.

Accessories

- Floor mounted door stop, (refer to page 313)
- HAWA-Toplock, (refer to pages 396-400)

Mounting options with wood fascias

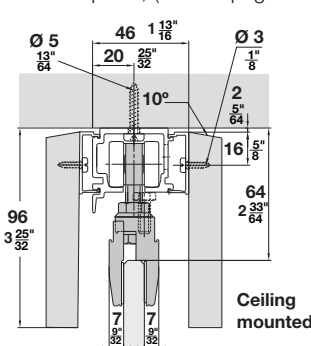
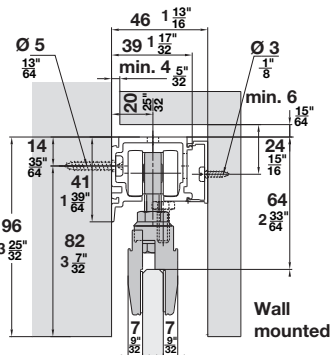

Fixing distance for clip component every 400 to 600 mm (15 3/4"-23 5/8")

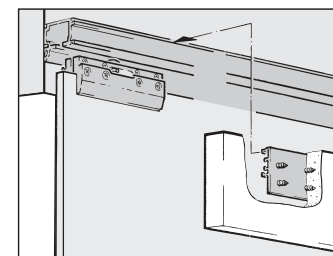

Dimensions in mm are exact
Inches are approximate

Dimensional data not binding. We reserve the right to alter specifications without notice.

Top Hung System

EKU-Porta 100/GF

- Combination sliding and fixed glass
- For 1 and 2 sliding glass doors
- Suspension with clamping shoe
- Rattle-free bottom guide
- Simple installation
- No glass cut-outs required
- Vertical adjustment without removing the glass door

- Maximum door weight: **100 kg** (220 lbs.)
- For glass thickness: **8 - 12.7 mm** (5/16" - 1/2")

Installation Tips

When using 2 sliding doors on the same track, please make sure that glass panels do not collide. Please use a lower guide channel with a door stopper or use protective edge trim.

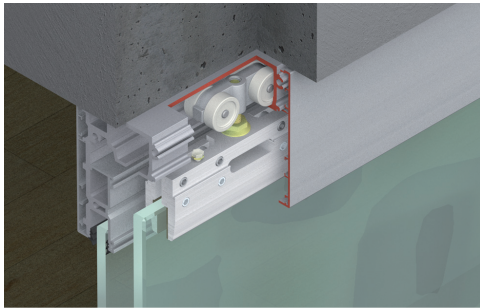
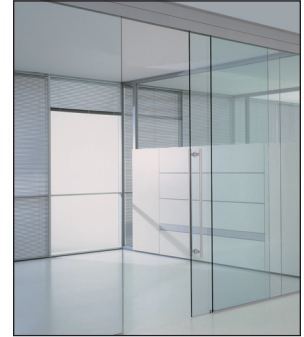

Wall Mounted

Ceiling Mounted

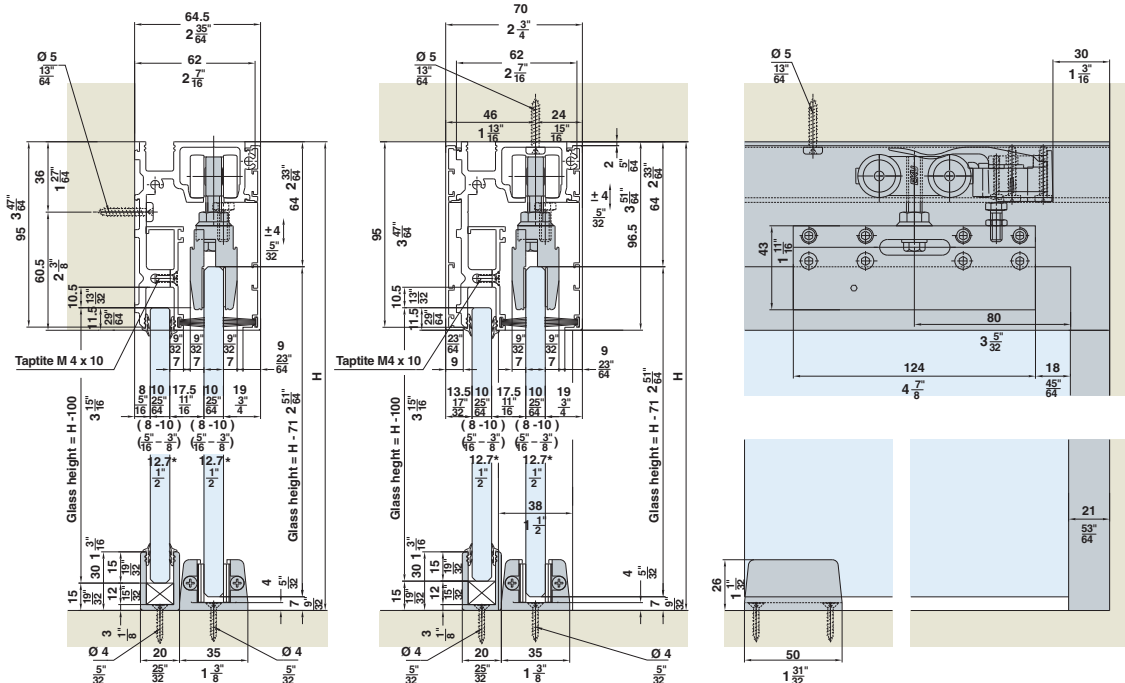







*12.7 mm glass possible with silicone sealing

Dimensions in mm are exact
Inches are approximate

Top Hung System

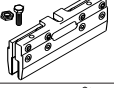
EKU-Porta 100/GF

Fitting Set

1 set				941.00.007
Consisting of:	Description	Material/Finish/Color	Packing	Item No.
	Double roller running gear		2 pcs.	941.00.012
	Suspension bolt, M8 x 35	steel, zinc-plated	2 pcs.	940.60.021
	Set nut, M8	steel, zinc-plated	2 pcs.	940.60.022
	Clamp shoe adjustable from 6 - 12.7 mm (1/4" - 1/2")	aluminum, mill finish	2 pcs.	941.00.020
	Track stopper, with adjustable retention spring	plastic, gray	1 pc.	940.60.043
	Track stopper	plastic gray	1 pc.	940.60.041
	Floor guide, adjustable from 6 - 12.7 mm (1/4" - 1/2")		1 pc.	941.00.031
	Buffer	rubber, black	1 pc.	940.60.051

Note: Item numbers are valid for only 1 piece, when ordering individual components please state the desired amount

Upper Tracks, pre-drilled, 95 x 62 mm (3 47/64" x 2 7/16")

	Material	Item No.
 2.5 m (8' 2 7/16")	aluminum, unanodized	941.00.254
6.0 m (19' 8 1/4")	aluminum, unanodized	941.00.604

Packing: 1 pc.

Clip-on Fascia to upper track, 94.5 x 9 mm (3 23/32" x 23/64")

	Material	Item No.
 2.5 m (8' 2 7/16")	aluminum, anodized	941.00.825
6.0 m (19' 8 1/4")	aluminum, anodized	941.00.860

Packing: 1 pc.

Support Profile for Fixed Glass, pre-drilled, 53 x 19 mm (2 3/32" x 3/4")

	Material	Item No.
 2.5 m (8' 2 7/16")	aluminum, anodized	941.01.825
6.0 m (19' 8 1/4")	aluminum, anodized	941.01.860



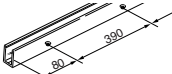

Packing: 1 pc.

Fixed Glazing Profile/Lower Guide Channel, pre-drilled, 30 x 20 mm (1 3/16" x 25/32")

	Material	Item No.
 2.5 m (8' 2 7/16")	aluminum, anodized	941.01.725
6.0 m (19' 8 1/4")	aluminum, anodized	941.01.760

Packing: 1 pc.

Components

	Material/Color	Packing	Item No.
 Fixing set for support profile and fixed glazing profile		1 set	941.01.899
 End piece to fascia, one-sided, wall mounted, 64 mm (2 33/64")	aluminum, anodized	1 set	941.00.068
 End piece to fascia, one-sided, ceiling mounted, 70 mm (2 3/4")	aluminum, anodized	1 set	941.00.069
 Sealing profile 20 m (65' 7 7/16")	rubber, black	1 roll	941.00.103
 Seal, 20 m (65' 7 7/16")	plastic, black	1 roll	941.00.094

Accessories

- Floor mounted door stop, (refer to page 313)
- HAWA-Toplock, (refer to pages 396-400)

Installation Plan: (included in fitting set), mounting instructions for planning and execution are available upon request.

Dimensions in mm are exact
Inches are approximate

Top Hung System

EKU-Porta 100/GFO

- Combination sliding and fixed glass including overhead glass transom
- For 1 and 2 sliding glass doors
- Suspension with clamping shoe
- Rattle-free bottom guide
- Simple installation
- No glass cut-outs required
- Vertical adjustment without removing the glass door

- Maximum door weight: **100 kg** (220 lbs.)
- For glass thickness: **8 - 12.7 mm** (5/16" - 1/2")
- Maximum clear width: **3048 mm** (10')

Installation Tips

When using 2 sliding doors on the same track, please make sure that glass panels do not collide. Please use a lower guide channel with a door stopper or use protective edge trim.

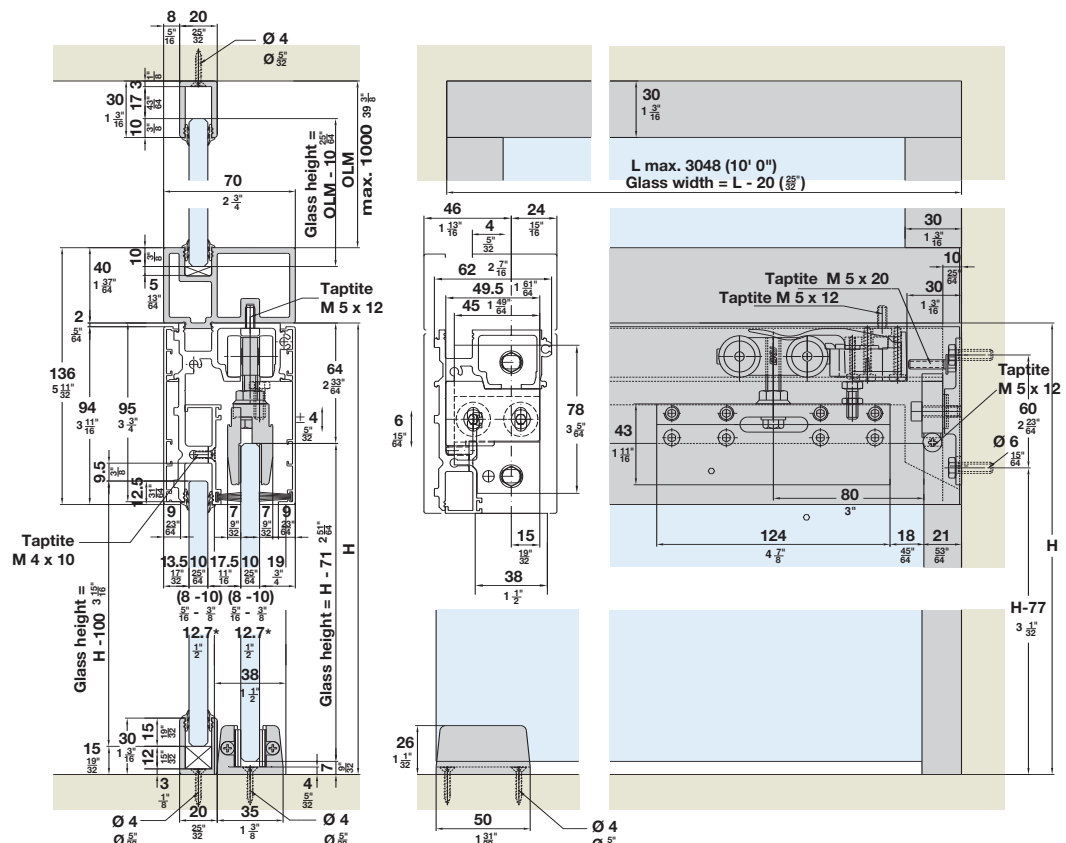
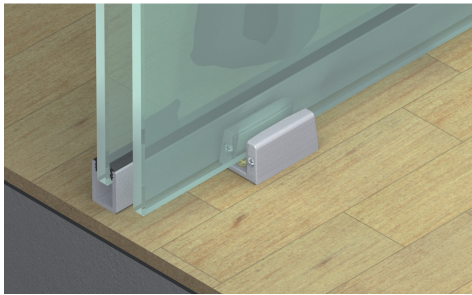
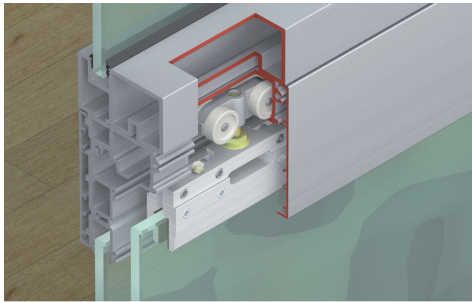







*12.7 mm glass possible with silicone sealing

Dimensional data not binding. We reserve the right to alter specifications without notice.

Top Hung System

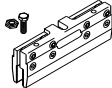
EKU-Porta 100/GFO

Fitting Set

1 set				941.00.007
Consisting of:	Description	Material/Color	Packing	Item No.
	Double roller running gear		2 pcs.	941.00.012
	Suspension bolt, M8 x 35	zinc-plated steel	2 pcs.	940.60.021
	Set nut, M8	zinc-plated steel	2 pcs.	940.60.022
	Clamp shoe adjustable from 6 - 12.7 mm (1/4" - 1/2")	aluminum, mill finish	2 pcs.	941.00.020
	Track stopper, with adjustable retention spring	plastic, gray	1 pc.	940.60.043
	Track stopper	plastic, gray	1 pc.	940.60.041
	Floor guide, adjustable from 6 - 12.7 mm (1/4" - 1/2")		1 pc.	941.00.031
	Buffer	rubber, black	1 pc.	940.60.051

Wall Brackets

Note: Item numbers are valid for only 1 piece, when ordering individual components please state the desired amount

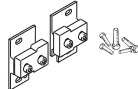
		Packing	Item No.
	Set for mounting 1 upper track	1 set	941.00.060

Upper Tracks, pre-drilled, 95 x 62 mm (3 47/64" x 2 7/16")

	Material	Item No.
 2.5 m (8' 2 7/16")	aluminum, unanodized	941.00.254
6.0 m (19' 8 1/4")	aluminum, unanodized	941.00.604

Reinforcement Profile, 43 x 70 mm (1 11/16" x 2 3/4")

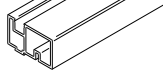
	Material	Item No.
 2.5 m (8' 2 7/16")	aluminum, anodized	941.01.525
6.0 m (19' 8 1/4")	aluminum, anodized	941.01.560

Clip-on Fascia to upper track, 94.5 x 9 mm (3 23/32" x 23/64")

	Material	Item No.
 2.5 m (8' 2 7/16")	aluminum, anodized	941.00.825
6.0 m (19' 8 1/4")	aluminum, anodized	941.00.860

Support Profile for Fixed Glass, pre-drilled, 53 x 19 mm (2 3/32" x 3/4")

	Material	Item No.
 2.5 m (8' 2 7/16")	aluminum, anodized	941.01.825
6.0 m (19' 8 1/4")	aluminum, anodized	941.01.860

Fixed Glazing Profile/Lower Guide Channel, pre-drilled, 30 x 20 mm (1 3/16" x 25/32")

	Material	Item No.
 2.5 m (8' 2 7/16")	aluminum, anodized	941.01.725
6.0 m (19' 8 1/4")	aluminum, anodized	941.01.760

Angle Profile for Fixed Glass, pre-drilled, 30 x 19 mm (1 3/16" x 3/4")

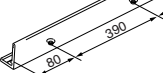
	Material	Item No.
 2.0 m (6' 6 3/4")	aluminum, anodized	941.01.420

Packing: 1 pc.

Dimensional data not binding. We reserve the right to alter specifications without notice.

Dimensions in mm are exact
Inches are approximate

Top Hung System

EKU-Porta 100/GFO

Angle Profile for Fixed Glass, 30 x 17 mm (1 3/16" x 11/16")

Description	Material	Item No.
 2.0 m (6' 6 3/4")	aluminum, anodized	941.01.320

Packing: 1 pc.

Wall Profile, 38 x 21 mm (1 1/2" x 59/64")

Description	Material	Item No.
 2.5 m (8' 2 7/16")	aluminum, anodized	941.24.925
3.5 m (11' 5 13/16")	aluminum, anodized	941.24.935



Packing: 1 pc.

Rubber Seal for Wall Profile

Description	Color	Item No.
 2.5 m (8' 2 7/16")	black	941.24.081
3.5 m (11' 5 13/16")	black	941.24.082

Packing: 1 pc.

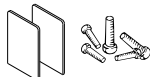
Components

Description	Material/Color	Packing	Item No.
 Fixing set for support profile and fixed glazing profile		1 set	941.01.899
 Sealing profile, 20 m (65' 7 7/16")	rubber, black	1 roll	941.00.103
 Seal, 20 m (65' 7 7/16")	plastic, black	1 roll	941.00.094

Accessories

- Floor mounted door stop, (refer to page **313**)
- HAWA-Toplock, (refer to pages **396-400**)

Installation Plan: (included in fitting set), mounting instructions for planning and execution are available upon request.

Top Hung System

EKU-Porta 100/GU

- For 1 and 2 sliding glass doors
- Smooth quiet operation
- Maintenance-free
- Rattle-free bottom guide
- Simple installation
- Vertical adjustment without removing the glass door

- Maximum door weight: **100 kg** (220 lbs.)
- For glass thickness of **8 - 12.7 mm** (5/16" - 1/2")

Installation Tips

When using 2 sliding doors on the same track, please make sure that glass panels do not collide. Please use a lower guide channel with a door stopper or use protective edge trim.

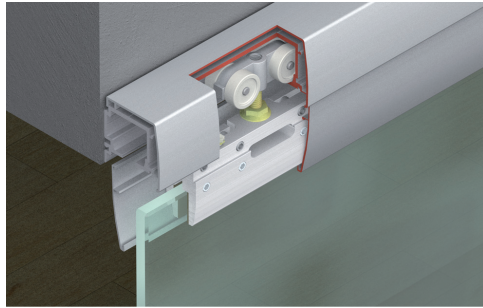

Wall Mounted

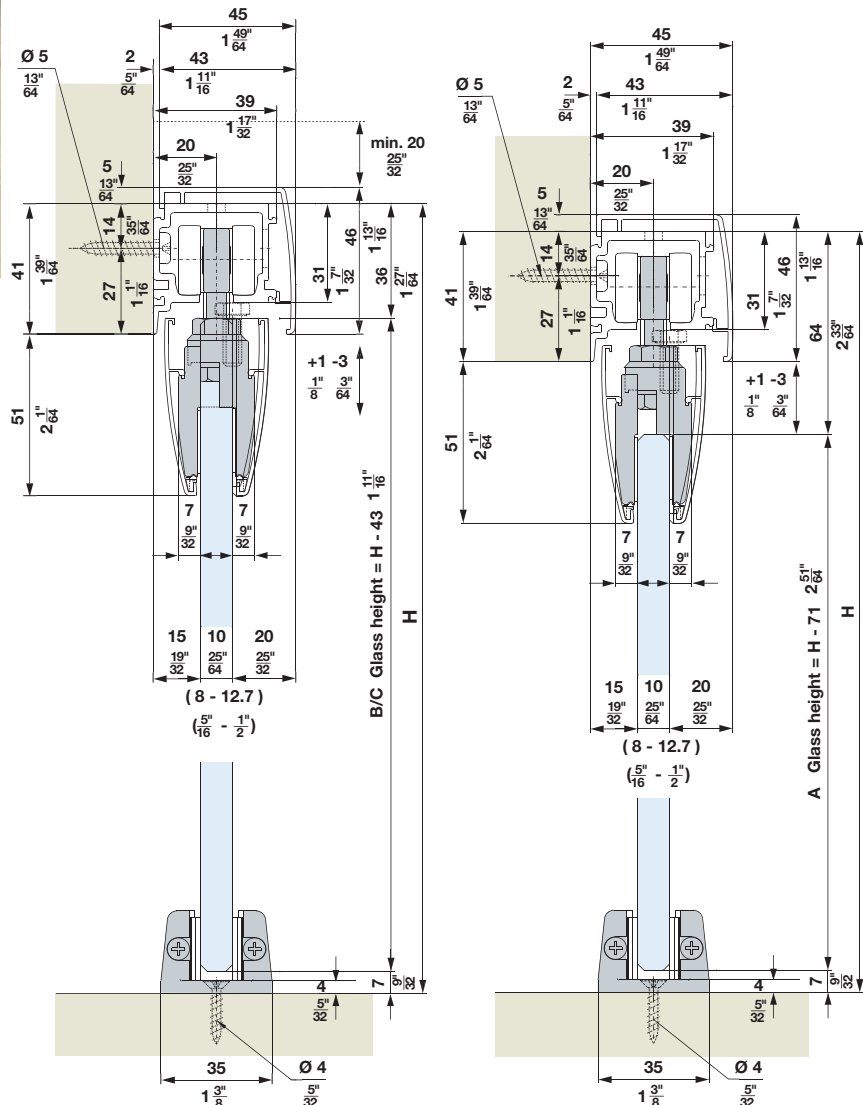







Dimensional data not binding. We reserve the right to alter specifications without notice.

Top Hung System

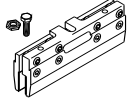
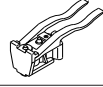
EKU-Porta 100/GU

Fitting Sets

1 set				941.00.007
Consisting of:	Description	Material/Finish/Color	Packing	Item No.
	Double roller running gear		2 pcs.	941.00.012
	Suspension bolt, M8 x 35	steel, zinc-plated	2 pcs.	940.60.021
	Set nut, M8	steel, zinc-plated	2 pcs.	940.60.022
	Clamp shoe adjustable from 6 - 12.7 mm (1/4" - 1/2")	aluminum, mill finish	2 pcs.	941.00.020
	Track stopper, with adjustable retention spring	plastic, gray	1 pc.	940.60.043
	Track stopper,	plastic, gray	1 pc.	940.60.041
	Floor guide, adjustable from 6 - 12.7 mm (1/4" - 1/2")		1 pc.	941.00.031
	Buffer	rubber, black	1 pc.	940.60.051

Note: • Item numbers are valid for only 1 piece, when ordering individual components please state the desired amount
 • For 2 bi-parting sliding glass doors please order 2 sets

Mounting Examples

With continuous clip-on fascia, glass cut-outs not required

With short clip-on fascia, glass cut-outs required

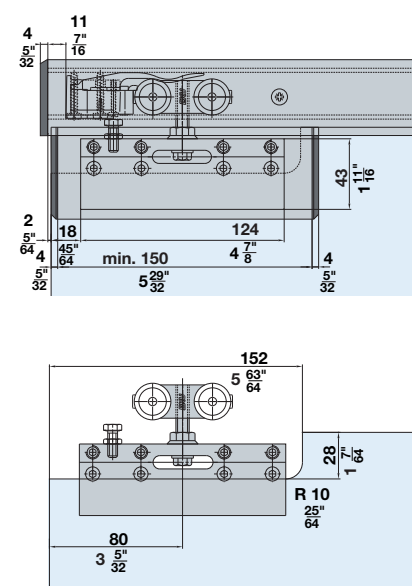
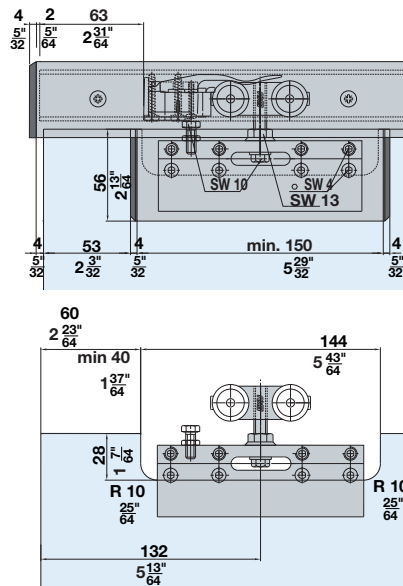
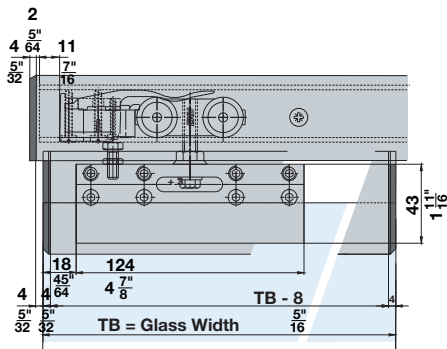
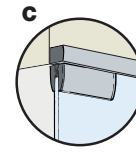
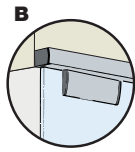
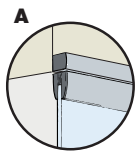

Dimensions in mm are exact
 Inches are approximate

Top Hung System

EKU-Porta 100/GU

Upper Tracks, pre-drilled, 41 x 39 mm (1 39/64" x 1 17/32")

Description	Material	Item No.
 2.5 m (8' 2 7/16")	aluminum, unanodized	941.00.253
6.0 m (19' 8 1/4")	aluminum, unanodized	941.00.603

Packing: 1 pc.

Clip-on Fascia, to upper track, 46 x 43 mm (1 13/16" x 1 11/16")

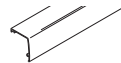
Description	Material	Item No.
 2.5 m (8' 2 7/16")	aluminum, anodized	941.01.925
6.0 m (19' 8 1/4")	aluminum, anodized	941.01.960

Packing: 1 pc.

Clip-on Fascia, to clamping shoe, 56 x 10 mm (2 13/64" x 25/64")

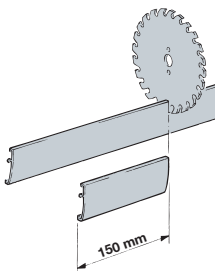
Description	Material	Item No.
 2.5 m (8' 2 7/16")	aluminum, anodized	941.01.625

Packing: 1 pc.

- Has to be cut to size, refer to drawings on page 336

End Caps, to clip-on fascia to upper track and clamp shoe

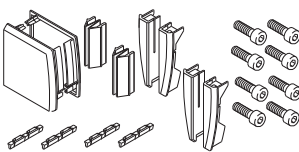
Description	Material/Color	Item No.
 Order requirements: Option A 1 set Option B and C 2 sets	plastic, anthracite	941.01.999

Packing: 1 set

Installation Plan: (included in fitting set), mounting instructions for planning and execution are available upon request.

Accessories

- Floor mounted door stop, (refer to page 313)
- HAWA-Toplock, (refer to pages 396-400)

Clip-on Fascias and End Caps can also be used for the HAWA-Junior 40 and 80/GS sliding systems, (refer to pages 290-293)