

1

HAWA Junior 80/Z

- Maximum door weight: 80 kg (176 lbs.)
- Minimum door thickness: 26 mm (1")
- For 1 and 2 sliding wood doors
- Smooth quiet operation
- Outstanding durability
- Rattle-free bottom guide
- Simple installation
- Special two-way suspension
- Vertically and laterally adjustable
- Door stop with adjustable retention spring

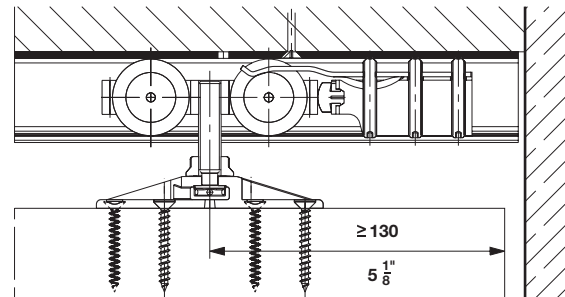
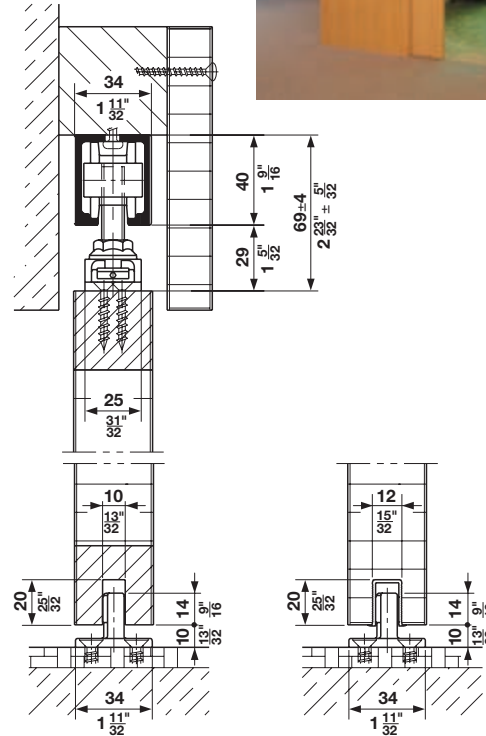
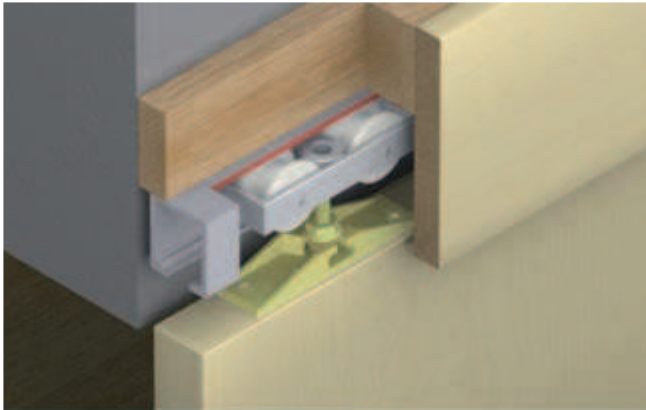

The two-way suspension bracket allows the door to be hung and to be taken off in two different ways:

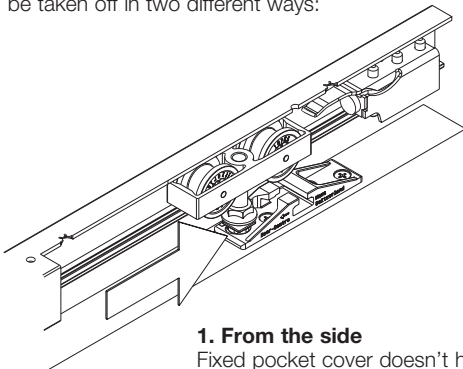

1. From the side

Fixed pocket cover doesn't have to be removed
Cover plate above opening has to be removable

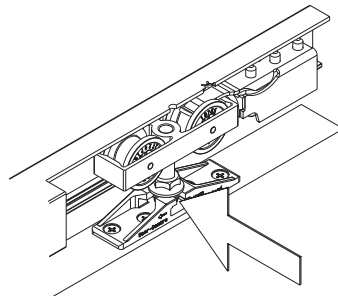

2. From the front

Dimensions in mm
Inches are approximate







AH **1.58**

HAWA Junior 80/Z Set

- For 1 sliding door without upper track and lower guide

	Item No.
	940.80.001



Set Components

	Description	Material	Finish	Qty.	Item No.
	Double roller running gear	Aluminum	–	2 pcs.	940.80.012
	Two-way suspension plate, M10 bolt and mounting screws	–	–	2 pcs.	940.80.022
	Floor mounted guide, rattle-free	Plastic	black	1 pc.	940.40.031
	Track stopper with adjustable retention spring	Zinc die-cast	–	1 pc.	940.80.040
	Wall buffer	Rubber	black	1 pc.	940.40.051
	Height adjusting pin	Steel	galvanized	1 pc.	940.40.091

Note

Item numbers are valid only for one piece, when ordering individual components, please state the desired amount. Depending on application, an additional track stopper has to be ordered with set. For 2 bi-parting sliding doors, please order 2 sets.

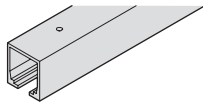
Individual Components

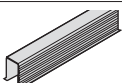
	Description	Material	Finish	Length	Item No.
	Upper track, pre-drilled	Aluminum	clear anodized	1.4 m (4' 7 1/8")	940.80.140
				1.6 m (5' 3")	940.80.160
				1.8 m (5' 10 7/8")	940.80.180
				2 m (6' 6 3/4")	940.80.200
				2.2 m (7' 2 5/8")	940.80.220
				2.5 m (8' 2 7/16")	940.80.250
				3 m (9' 10 1/8")	940.80.300
				4 m (13' 1 1/2")	940.80.400
	6 m (19' 8 1/4")	940.80.600			
	Cover cap, for upper track	Zinc die-cast	chrome matt	–	940.80.021
	Guide rail, glue-in type	Plastic	black	1.3 m (4' 3 1/8")	940.41.130

Installation Plan

(Included in fitting set), mounting instructions for planning and execution available upon request.

Confort guides	page 1.198
Angle profile	page 1.196
Other lower guide options	page 1.199
Futura framing kit	pages 1.189–1.191
SoundEx bracket	page 1.197
Soft close	page 1.195

Complete Sets

Door panel width	Track length	Item No.
up to 70 cm (27 9/16")	1.4 m (4' 7 1/8")	407.59.144
up to 80 cm (31 1/2")	1.6 m (5' 3")	407.59.162
up to 90 cm (35 7/16")	1.8 m (5' 10 7/8")	407.59.180
up to 100 cm (39 3/8")	2 m (6' 6 3/4")	407.59.206
up to 110 cm (43 5/16")	2.2 m (7' 2 5/8")	407.59.224
up to 125 cm (49 3/16")	2.5 m (8' 2 7/16")	407.59.251

Supplied With

Upper track	Running gear
Two-way suspension plates	Track stopper
Guide	Rubber bumper
Height adjusting pin	

Dimensions in mm
Inches are approximate