

EKU Clipo 16 GPK/GPPK Inside

- Maximum door weight: 16 kg. (35 lbs.)
 Maximum door height: 1400 mm (55 1/8")
 Maximum door width: 1000 mm (39 3/8")
 For glass thickness of 6 - 6.35 mm (1/4")
 Height adjustment: +2/-1 mm (+/- 1/16")
- No glass drilling
 - Clip-on running gear provides quick installation
 - For bypassing, frameless glass doors
 - Top hung system allows for no track or groove to be placed in the bottom of the cabinet
 - Optional soft closing available to prevent door slam
 - GPK Version: Glass fixing profile is not required on the bottom of the door. Featured in photograph below
 - GPPK Version: Glass fixing profile is on the top and bottom

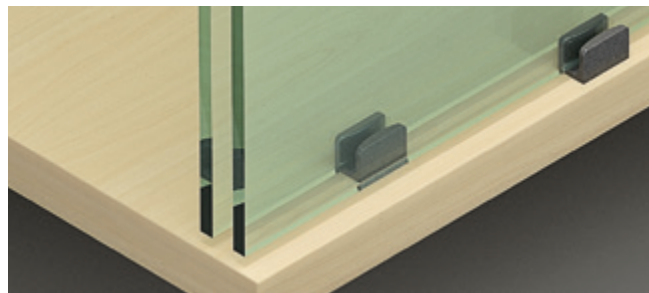
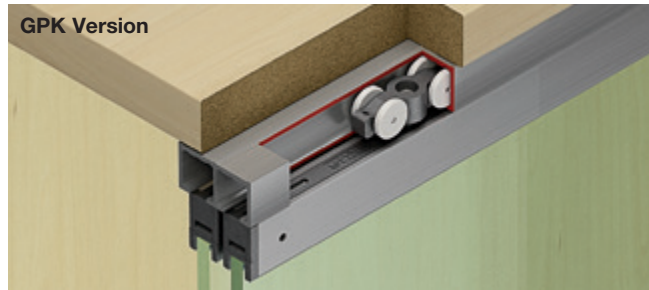

7

Running Gear Installation

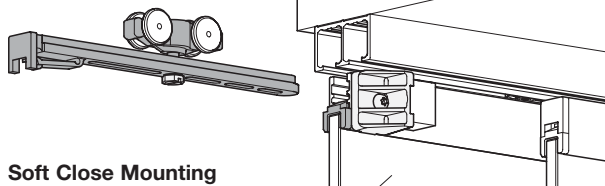

Soft Close Mounting

Door with one soft close mechanism.

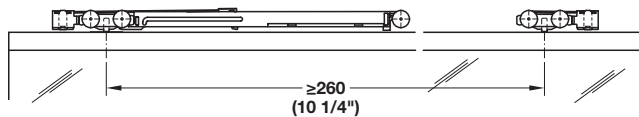

Door with two soft close mechanisms.

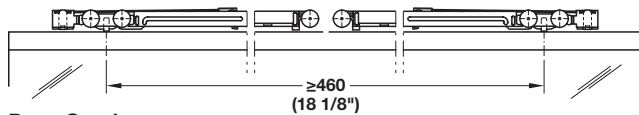

Door Overlay

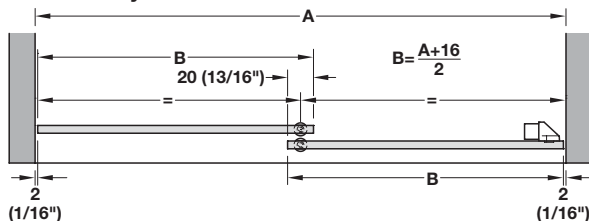

Dimensions in mm
 Inches are approximate

**Installation Dimensions
 Clipo 16 GPK**

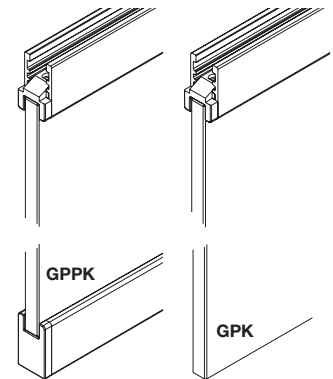
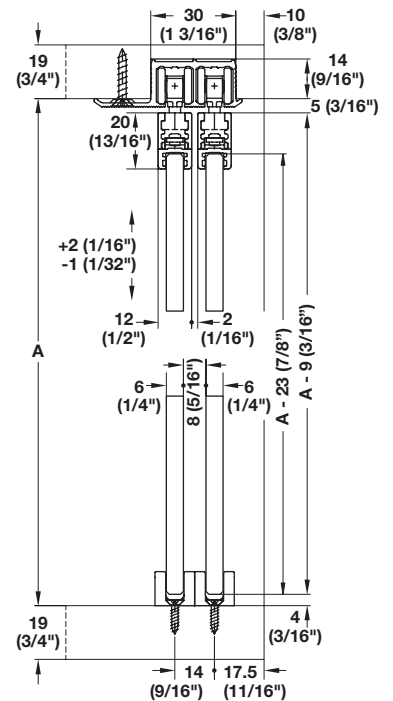
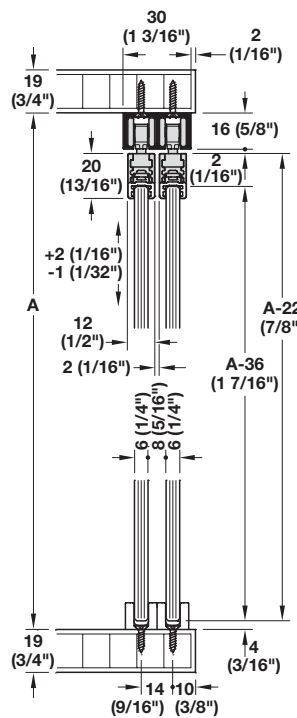

Clipo 16 GPPK

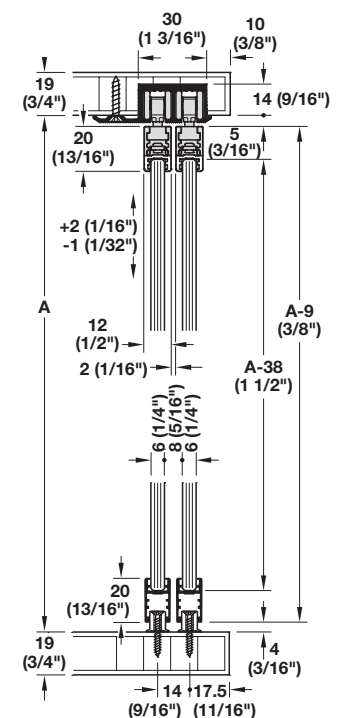
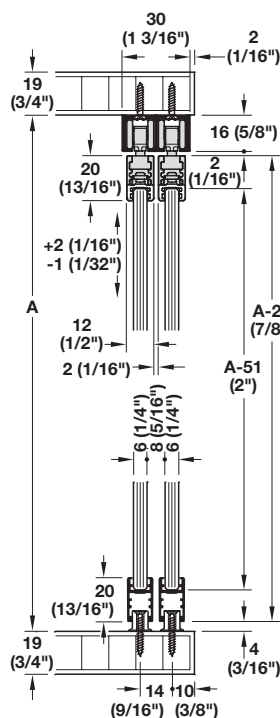

Dimensional data not binding. We reserve the right to alter specifications without notice.







EKU Clipo 16 GPK/GPPK Inside Set

	Item No.
Clipo 16 GPK, for 2 sliding doors	405.82.290
Clipo 16 GPPK, for 2 sliding doors	405.82.291













Note

The complete set is always delivered without upper track, glass fixing profile and accessories, please order separately.

Set Components

Description	Material	Finish/Color	Qty.	Item No.
 Running gear, slides and clips into locking component	Plastic	anthracite	4 pcs.	-
 Locking component, mounts to glass fixing profile	Plastic	anthracite	4 pcs.	-
 Guide for GPK version	Plastic	light gray	2 pcs.	405.83.105
 Guide for GPPK version	Plastic	gray	2 pcs.	405.83.314
 Door stop, mounts to top glass fixing profile on outer door	Plastic	light gray	1 pc.	-
 Track stopper	Plastic	gray	2 pcs.	405.83.981
 Cover cap for GPPK version, for bottom glass fixing profile	Plastic	anthracite	4 pcs.	-

Individual Components

Description	Min. Top Panel Thickness	Material	Color	Length	Qty.	Item No.
 Glass fixing profile, top and bottom, for glue mounting	-	Aluminum	silver colored anodized,	2.5 m (8' 2 7/16")	-	405.89.932
 Double upper track, surface mounted, for screw mounting	19 mm (3/4")	Aluminum	silver colored anodized,	2.5 m (8' 2 7/16")	-	405.90.962
 Double upper track, recessed mounted, for screw mounting	19 mm (3/4")	Aluminum	bright	2.5 m (8' 2 7/16")	-	405.90.972
 Single upper track, for gluing into groove (polyurethane glue recommended)	19 (3/4")	Aluminum	bright	2.5 m (8' 2 7/16")	-	405.87.042
 Single upper track, with rotating fasteners (not suitable for hard wood)	19 (3/4")	Aluminum	bright	2.5 m (8' 2 7/16")	-	405.87.092
 Single upper track, pre-drilled, for screw mounting	30 (1 3/16")	Aluminum	bright	2.5 m (8' 2 7/16")	-	405.87.082
 Soft closing mechanism	-					For doors < 8 kg (17.6 lbs.) 405.10.077
 One set includes two mechanisms. Two sets are required for dual soft closing of two doors.	-	Plastic	gray	-	1 set	For doors 8 kg - 16 kg (17.6- 35 lbs.) 405.10.075
 Service port, for single upper track with rotating fasteners (to access running gear after installation)	-	Plastic	gray	-	-	405.83.180
 Service port, for single upper track for screw mounting (to access running gear after installation)	-	Plastic	gray	-	-	405.83.181
 Knob, Ø10 mm (3/8")	-	Aluminum	anodized	-	-	405.46.910
 Flush pull, Ø30 mm (1 3/16"), for screw or glue mounting	-	Aluminum	anodized	-	-	405.46.900

Dimensional data not binding. We reserve the right to alter specifications without notice.

Dimensions in mm
 Inches are approximate