

Häfele Slido Design 25 IF G

Maximum door weight: 25 kg (55 lbs.)
 Maximum door height: 1400 mm (4' 7 1/8")
 Minimum door width: 600 mm (1' 11 5/8")
 Maximum door width: 1200 mm (3' 11 1/4")
 For 6 mm (1/4") tempered glass

- Running gear with slide-in technology for quick and easy installation
- Very smooth running action
- Perfect for interior transaction windows and showcase cabinets

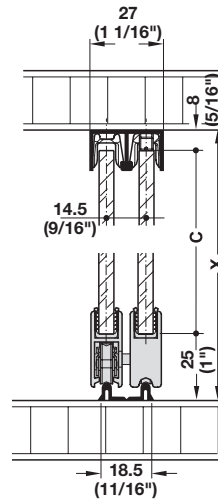
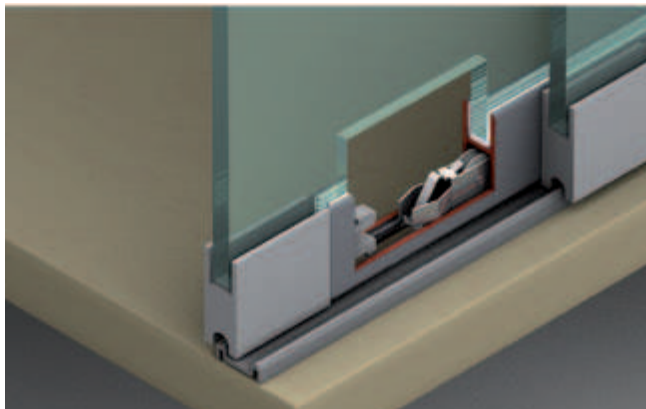

Calculations:

Glass height: $C = X - (25 + 8)$
 (1" + 5/16")

Glass width:

A = internal cabinet width

B = door overlap

N = number of door leaves

NE = number of end caps

① For end cap 415.13.020

$$\frac{A + B}{N} - (NE \times 2.5)$$

② For end cap 415.13.021

$$\frac{A + B}{N}$$

End cap

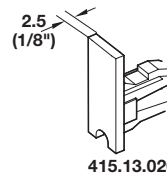

Refer to equation ① for glass width

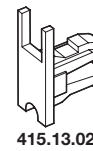

Refer to equation ② for glass width

Glass profile grip

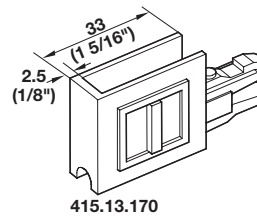

Refer to equation ① for glass width

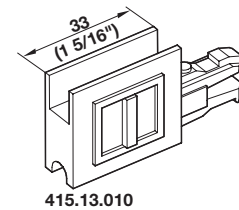

Refer to equation ② for glass width

Running gear installation into glass profile

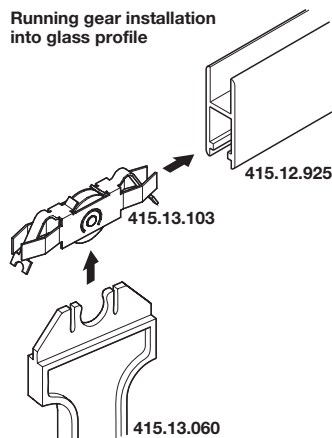

Lock housing and cylinder core

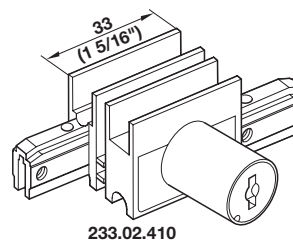

Refer to equation ② for glass width

Dimensions in mm
 Inches are approximate