

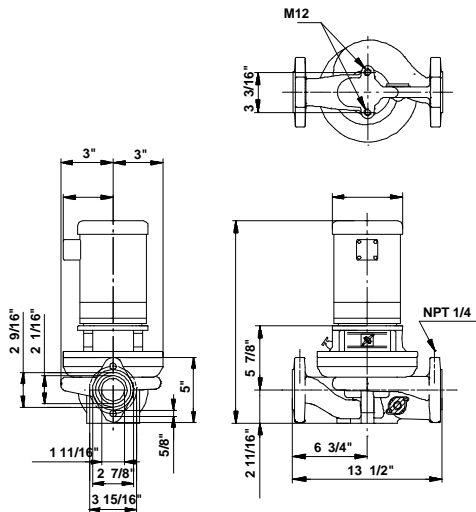

Position	Count	Description	Unit price
	-1	<p><b>TP 32-160/2 U-G-Z-BUBE</b></p>  <p>Product photo could vary from the actual product</p> <p>Product No.: 91122123                      Single-stage centrifugal in-line single-head pump.</p> <p>The in-line design with opposite suction and discharge ports enables mounting in pipework or on a concrete foundation.</p> <p>The shaft seal is a corrosion-resistant maintenance-free mechanical seal.</p> <p><b>Liquid:</b>                      Liquid temperature range: 5 .. 284 °F                      Liquid temp: 68 °F</p> <p><b>Technical:</b>                      Actual calculated flow: 38.7 US gpm                      Resulting head of the pump: 38.4 ft                      Shaft seal: BUBE                      Maximum operating pressure: 145 psi</p> <p><b>Materials:</b>                      Pump housing: Bronze                      DIN W.-Nr. 2.1093                      Impeller: Stainless steel                      DIN W.-Nr. 1.4301                      AISI 304</p> <p><b>Installation:</b>                      Maximum operating pressure: 145 psi                      Flange standard: USA                      Pipe connection: 1 1/2"</p> <p><b>Electrical data:</b>                      Number of poles: 2                      Power (P2) required by pump: 0.738 HP                      Main frequency: 60 Hz</p>	On request

Description	Value
Product name:	TP 32-160/2 U-G-Z-BUBE U-G-Z BUBE
Product Number:	91122123
EAN number:	5700394584296
<b>Technical:</b>	
Actual calculated flow:	38.7 US gpm
Resulting head of the pump:	38.4 ft
Head max:	52.5 ft
Shaft seal:	BUBE
Maximum operating pressure:	145 psi
Pump version:	U
<b>Materials:</b>	
Pump housing:	Bronze DIN W.-Nr. 2.1093
Impeller:	Stainless steel DIN W.-Nr. 1.4301 AISI 304
Material code:	Z
<b>Installation:</b>	
Maximum operating pressure:	145 psi
Flange standard:	USA
Connect code:	G
Pipe connection:	1 1/2"
<b>Liquid:</b>	
Liquid temperature range:	5 .. 284 °F
Liquid temp:	68 °F
<b>Electrical data:</b>	
Number of poles:	2
Power (P2) required by pump:	0.738 HP
Main frequency:	60 Hz
<b>Others:</b>	
Country code:	Namreg

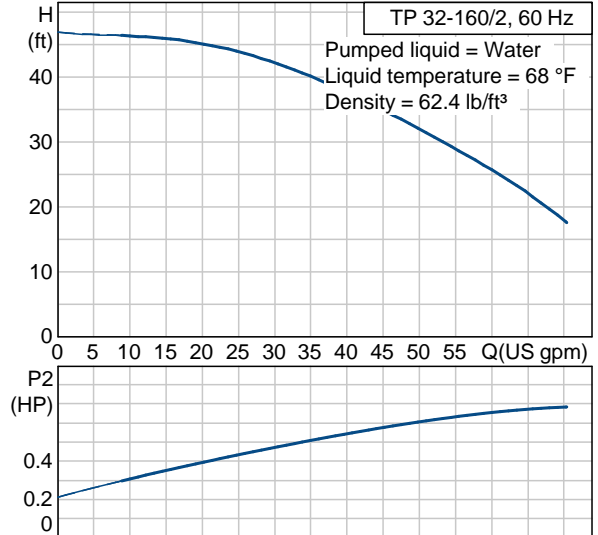

91122123 TP 32-160/2 60 Hz

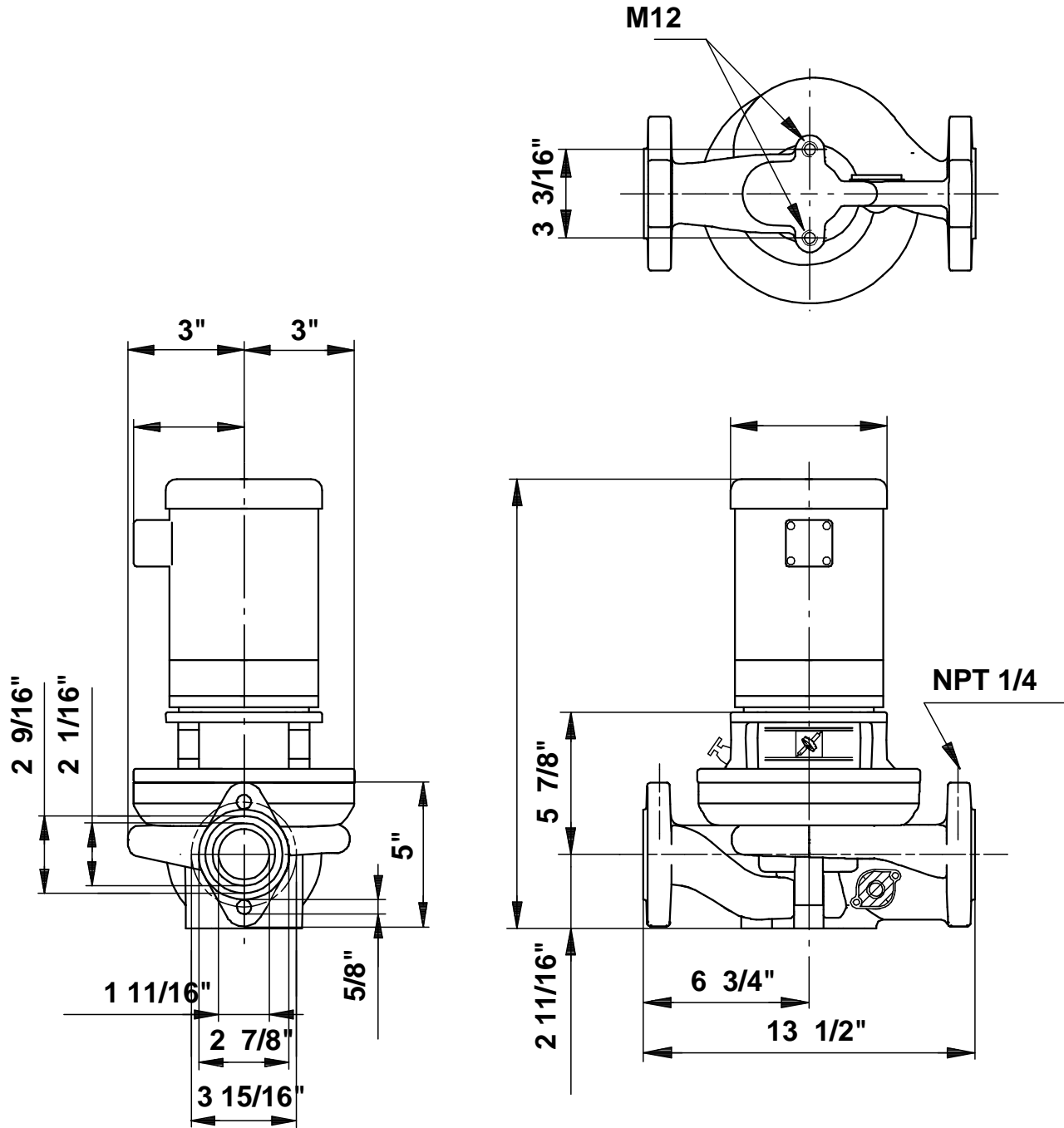

Note! All units are in [mm] unless others are stated.  
 Disclaimer: This simplified dimensional drawing does not show all details.