

ESSENCE
Pressure Balance Valve Trim
MODEL # 19347A01

Pure Freude
an Wasser

GROHE

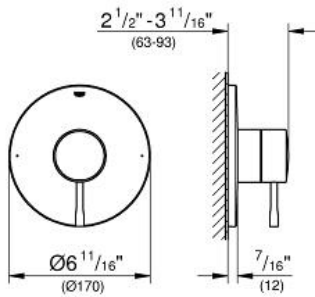

ADA

C

Product Description:
ESSENCE
Pressure Balance Valve Trim

Standard Specification:

- Final installation set for:
- Requires GrohFlex Universal Rough-In Box (35 026 000)
- **GROHE StarLight** finish

Applicable Codes & Standards:

- Energy Policy Act of 1992
- ASME A112.18.1/CSA B125.1
- ICC/ANSI A117.1
- MASS

Color:
□ 19347A01

GROHFLEX™
 Universal Rough-In Box
 MODEL # 35026

Pure Freude an Wasser



GROHE America, Inc | 200 North Gary Avenue, Suite G, Roselle, IL 60172
 Phone: +1 (800) 444-7643 | Fax: +1 (800) 225-2778 | us-customerservice@grohe.com

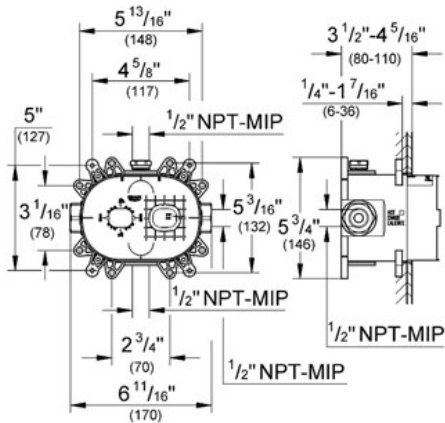
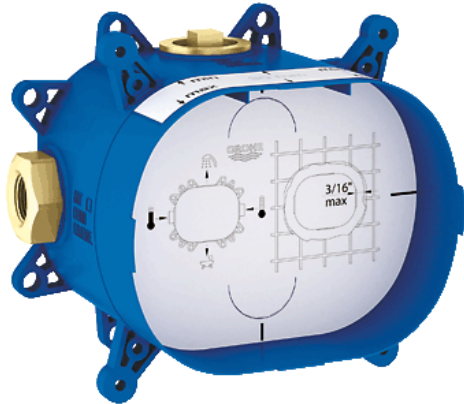

Product Description:
 Universal Rough-In Box

Standard Specification:

- Inlets and outlets $\frac{1}{2}''$
- Fixing points for front and back wall
- Leakproof housing
- Integrated service stops
- Flushing plug
- Removable protection cover with installation information
- For use with the GrohFlex Bathroom Solution Kits (sold separately):
 - Pressure Balance Valves and Thermostats
 - Single Function, Dual Function or Custom Shower

Applicable Codes & Standards:

- Energy Policy Act of 1992
- ASME A112.18.1/CSA B125.1

Color:

□ 35026 000

NEW TEMPESTA
COSMOPOLITAN 100
Shower Head 4 Sprays
MODEL # 26043A01

Pure Freude
an Wasser

GROHE

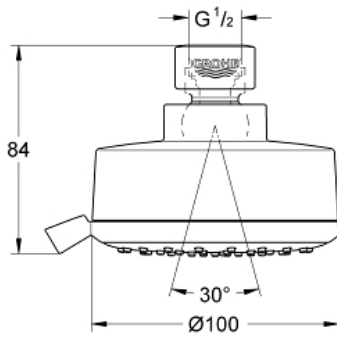
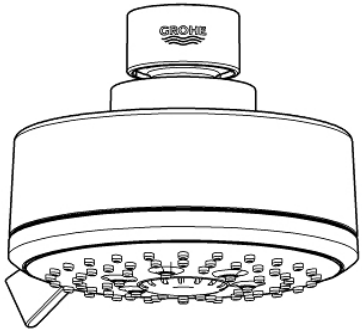

Product Description:
NEW TEMPESTA COSMOPOLITAN 100
Shower Head 4 Sprays

Standard Specification:

- 4 Sprays: GROHE Rain O², Rain, Massage and Jet
- Rotating ball joint ± 15°
- 1/2" Connection thread
- **GROHE EcoJoy** 1.75 gpm (6.6 l/min) flow limiter
- **GROHE DreamSpray** perfect spray pattern
- **GROHE StarLight** finish
- **SpeedClean** anti-lime system
- Inner WaterGuide for a longer life
- Max Flow Rate: 1.75 gpm (6.6 L/min)
- Min. recommended pressure: 15 psi (1.0 bar)

Applicable Codes & Standards:

- Energy Policy Act of 1992
- ASME A112.18.1/CSA B125.1
- EPA WaterSense®
- CalGreen

Color:

□ 26043A01

RELEXA
6 5/8" Tubular Shower Arm
MODEL # 27412BE0

Pure Freude
an Wasser

GROHE

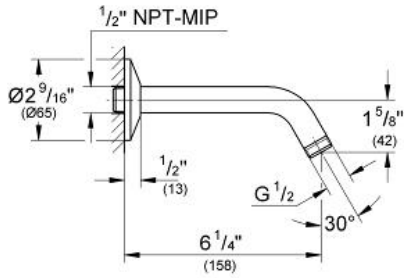

Product Description:

RELEXA

6 5/8" Tubular Shower Arm

Standard Specification:

- GROHE StarLight chrome finish

Applicable Codes & Standards:

- Energy Policy Act of 1992
- ASME A112.18.1/CSA B125.1

Color:

- 27412BE0 Polished Nickel InfinityFinish

CONCETTO
Tub Spout
MODEL # 13275A01

Pure Freude
an Wasser

GROHE

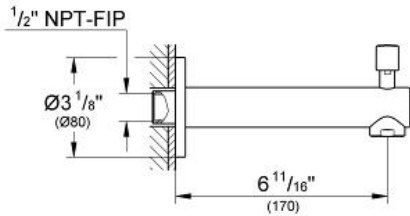
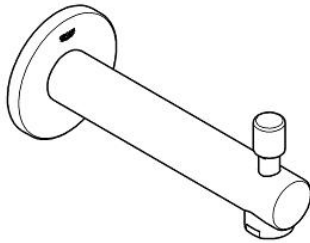

ADA

C

Product Description:
CONCETTO
Tub Spout

Standard Specification:

- Wall mount
- GROHE StarLight finish
- Flow control
- Automatic diverter: bath/shower
- 1/2" (13 mm) NPT Male Threads
- 6 11/16" (170 mm) spout reach

Applicable Codes & Standards:

- Energy Policy Act of 1992
- ASME A112.18.1/CSA B125.1
- ICC/ANSI A117.1
- MASS

Color:

□ 13275A01