

ESSENCE
Pressure Balance Valve Trim
MODEL # 19347A01

Pure Freude
an Wasser

GROHE

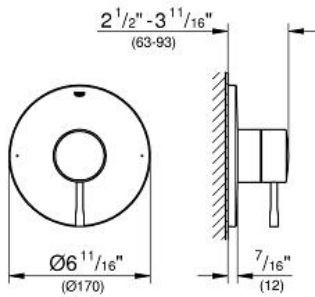

ADA

C

Product Description:
ESSENCE
Pressure Balance Valve Trim

Standard Specification:

- Final installation set for:
- Requires GrohFlex Universal Rough-In Box (35 026 000)
- **GROHE StarLight** finish

Applicable Codes & Standards:

- Energy Policy Act of 1992
- ASME A112.18.1/CSA B125.1
- ICC/ANSI A117.1
- MASS

Color:
□ 19347A01

GROHFLEX™
 Universal Rough-In Box
 MODEL # 35026

Pure Freude an Wasser



GROHE America, Inc | 200 North Gary Avenue, Suite G, Roselle, IL 60172
 Phone: +1 (800) 444-7643 | Fax: +1 (800) 225-2778 | us-customerservice@grohe.com

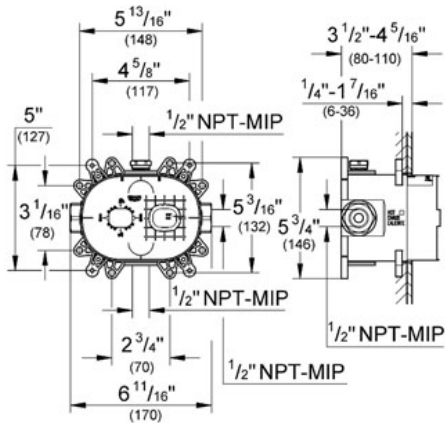
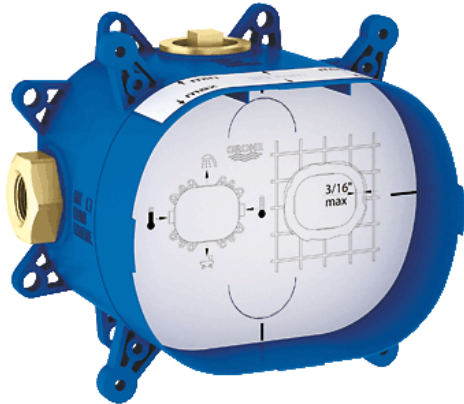

Product Description:
 Universal Rough-In Box

Standard Specification:

- Inlets and outlets $\frac{1}{2}''$
- Fixing points for front and back wall
- Leakproof housing
- Integrated service stops
- Flushing plug
- Removable protection cover with installation information
- For use with the GrohFlex Bathroom Solution Kits (sold separately):
 - Pressure Balance Valves and Thermostats
 - Single Function, Dual Function or Custom Shower

Applicable Codes & Standards:

- Energy Policy Act of 1992
- ASME A112.18.1/CSA B125.1

Color:

□ 35026 000

NEW TEMPESTA
COSMOPOLITAN 100
Shower Head 4 Sprays
MODEL # 26043A01

Pure Freude
an Wasser

GROHE

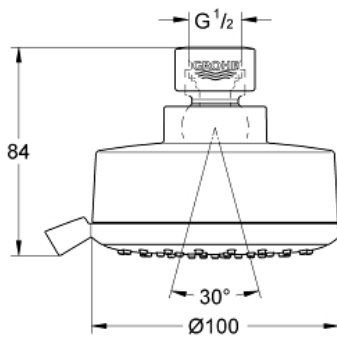
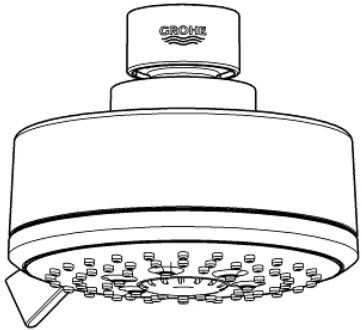

Product Description:
NEW TEMPESTA COSMOPOLITAN 100
Shower Head 4 Sprays

Standard Specification:

- 4 Sprays: GROHE Rain O², Rain, Massage and Jet
- Rotating ball joint $\pm 15^\circ$
- 1/2" Connection thread
- GROHE EcoJoy 1.75 gpm (6.6 l/min) flow limiter
- GROHE DreamSpray perfect spray pattern
- GROHE StarLight finish
- SpeedClean anti-lime system
- Inner WaterGuide for a longer life
- Max Flow Rate: 1.75 gpm (6.6 L/min)
- Min. recommended pressure: 15 psi (1.0 bar)

Applicable Codes & Standards:

- Energy Policy Act of 1992
- ASME A112.18.1/CSA B125.1
- EPA WaterSense[®]
- CalGreen

Color:

□ 26043A01

RELEXA
6 5/8" Tubular Shower Arm
MODEL # 27412BE0

Pure Freude
an Wasser

GROHE

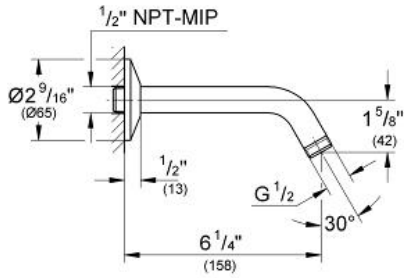

Product Description:
RELEXA
6 5/8" Tubular Shower Arm

Standard Specification:

- GROHE StarLight chrome finish

Applicable Codes & Standards:

- Energy Policy Act of 1992
- ASME A112.18.1/CSA B125.1

Color:

- 27412BE0 Polished Nickel InfinityFinish

RAINSHOWER
Shower Wall Union, 1/2"
MODEL # 26635BE0

Pure Freude
an Wasser

GROHE

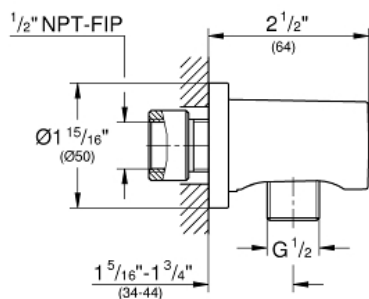
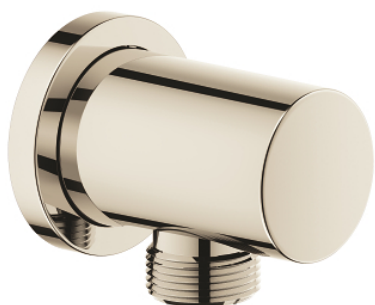

Product Description:
RAINSHOWER
Shower Wall Union, 1/2"

Standard Specification:

- 1/2" NPT Female Threads
- Check valve included to prevent backflow
- GROHE StarLight finish

Applicable Codes & Standards:

- ASME A112.18.1/CSA B125.1

Color:
□ 26635BE0

ROTAFLEX METAL LONGLIFE
Longlife Metal shower hose
Twistfree 1500
MODEL # 28417A00

Pure Freude
an Wasser



Product Description:
ROTAFLEX METAL LONGLIFE
Longlife Metal shower hose Twistfree 1500

Standard Specification:

- 59"
- Metal
- Longlife
- Strengthened model
- Tensile strength 500 N
Pressure resistance: up to 16 bar
- Heat resistance 165°F
- AntiFold bend proof
- Universal connection G 1/2" x 1/2"
- Rotation cone for Twist-free function
- Silicone strip prevents hand shower from turning while in body spray position
- **GROHE StarLight** finish
- Blister pack

Applicable Codes & Standards:

- ASME A112.18.1/CSA B125.1

Color:

- 28417A00

SENA STICK
Hand Shower
MODEL # 26465A00

Pure Freude
an Wasser

GROHE

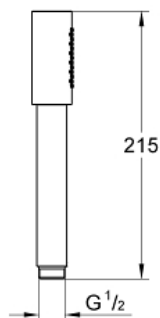

Product Description:
SENA STICK
Hand Shower

Standard Specification:

- 1 Spray: Normal
- Metal
- GROHE EcoJoy 1.75 gpm (6.6 l/min) flow limiter
- GROHE DreamSpray perfect spray pattern
- GROHE StarLight finish
- SpeedClean anti-lime system
- Inner WaterGuide for a longer life
- Universal mounting system (fits all standard shower hoses)
- Suitable for instantaneous heater

Applicable Codes & Standards:

- Energy Policy Act of 1992
- ASME A112.18.1/CSA B125.1
- EPA WaterSense®
- CalGreen

Color:

- 26465A00 Hard graphite

RAINSHOWER
Wall Hand Shower Holder
MODEL # 27074A00

Pure Freude
an Wasser

GROHE

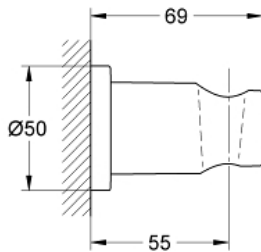
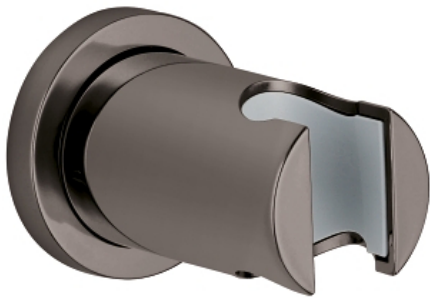

Product Description:
RAINSHOWER
Wall Hand Shower Holder

Standard Specification:

- Non-Adjustable Shower Head
- With round escutcheon
- GROHE StarLight finish

Applicable Codes & Standards:

- ASME A112.18.1/CSA B125.1

Color:
□ 27074A00

CONCETTO
Tub Spout
MODEL # 13274A01

Pure Freude
an Wasser

GROHE

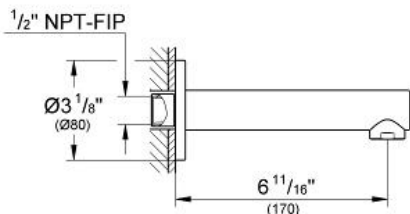
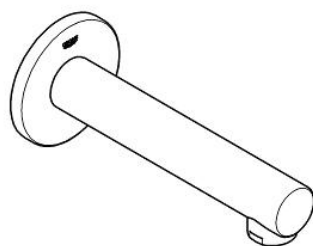

ADA

C

Product Description:
CONCETTO
Tub Spout

Standard Specification:

- Wall mount
- GROHE StarLight finish
- Flow control
- 6 11/16" (170 mm) spout reach
- 1/2" (13 mm) NPT Male Threads

Applicable Codes & Standards:

- Energy Policy Act of 1992
- ASME A112.18.1/CSA B125.1
- ICC/ANSI A117.1
- MASS

Color:

□ 13274A01

ESSENCE
3-Way Diverter Trim
MODEL # 29203001

Pure Freude
an Wasser

GROHE

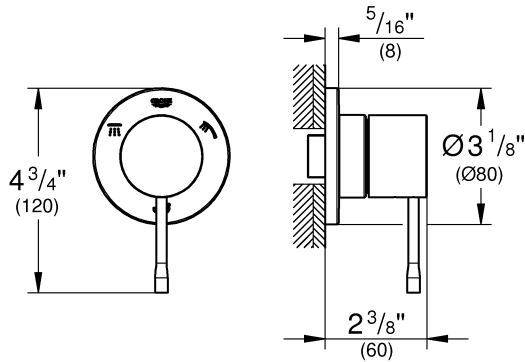

Product Description:

**ESSENCE
3-Way Diverter Trim**

Standard Specification:

- GROHE StarLight chrome finish
- Metal lever handle for 3 outlets: showerhead/hand shower/tub spout
- For use with 3-way diverter rough-in valves (29 902) or (29 903)
- ADA Compliant

Applicable Codes & Standards:

- ICC/ANSI A117.1

Color:

- 29203001 Starlight Chrome