

5 5/8" Tubular Shower Arm

MODEL # 27414

Pure Freude an Wasser



GROHE America, Inc | 200 North Gary Avenue, Suite G, Roselle, IL 60172
Phone: +1 (800) 444-7643 | Fax: +1 (800) 225-2778 | us-customerservice@grohe.com



Product Description:
5 5/8" Tubular Shower Arm

Standard Specification:

- GROHE StarLight® finish
- 1/2" Connection thread
- Projection 5 5/8"

Applicable Codes & Standards:

- Energy Policy Act of 1992
- ASME A112.18.1/CSA B125.1

Color:

- 27414 000 chrome
- 27414 EN0 Brushed Nickel

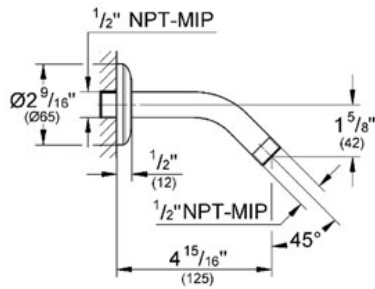

EUROCUBE

Single function pressure balance trim with control module

MODEL # 19924

GROHE America, Inc | 200 North Gary Avenue, Suite G, Roselle, IL 60172
 Phone: +1 (800) 444-7643 | Fax: +1 (800) 225-2778 | us-customerservice@grohe.com

Pure Freude an Wasser

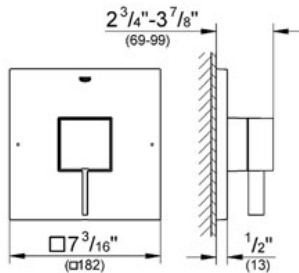
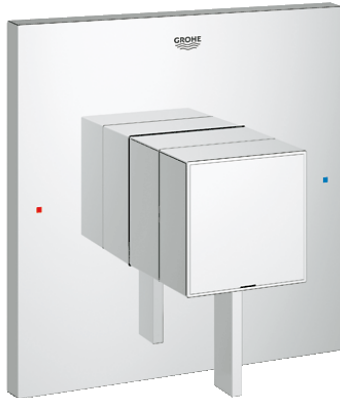

Product Description:
 Single function pressure balance trim with control module

- Standard Specification:**
- GROHE SilkMove®
 - GROHE StarLight® finish
 - For shower only or shower/tub with diverter applications
 - Integrated bypass option when used with diverter tub spout
 - For use with GrohFlex™ universal rough-in box 35 026 000 sold separately
 - 6.1 gpm at 45 psi

- Applicable Codes & Standards:**
- Energy Policy Act of 1992
 - ASME A112.18.1/CSA B125.1
 - US Federal and State material regulations
 - ICC/ANSI A117.1

Color:
 19924 000 chrome

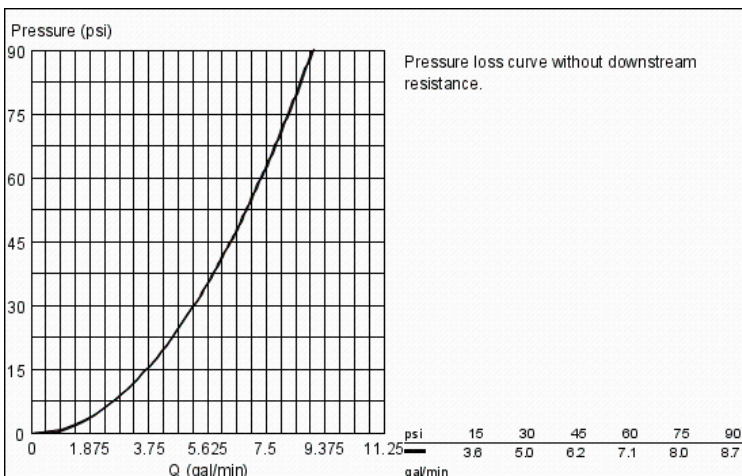

GROHFLEX™
 Universal Rough-In Box
 MODEL # 35026

Pure Freude an Wasser



GROHE America, Inc | 200 North Gary Avenue, Suite G, Roselle, IL 60172
 Phone: +1 (800) 444-7643 | Fax: +1 (800) 225-2778 | us-customerservice@grohe.com

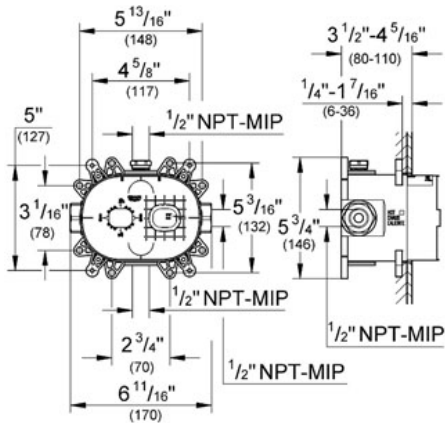
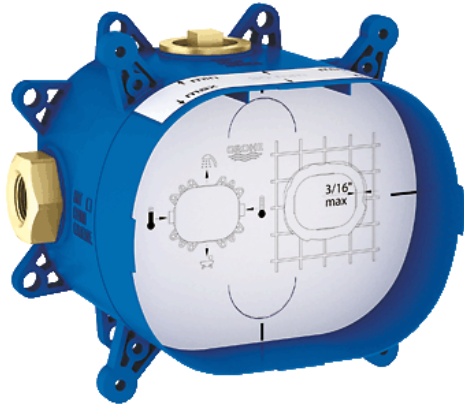

Product Description:
 Universal Rough-In Box

Standard Specification:

- Inlets and outlets 1/2"
- Fixing points for front and back wall
- Leakproof housing
- Integrated service stops
- Flushing plug
- Removable protection cover with installation information
- For use with the GrohFlex Bathroom Solution Kits (sold separately):
 - Pressure Balance Valves and Thermostats
 - Single Function, Dual Function or Custom Shower

Applicable Codes & Standards:

- Energy Policy Act of 1992
- ASME A112.18.1/CSA B125.1

Color:

□ 35026 000

NEW TEMPESTA
COSMOPOLITAN 100
Head shower 4 sprays
MODEL # 27591

Pure Freude an Wasser



GROHE America, Inc | 200 North Gary Avenue, Suite G, Roselle, IL 60172
Phone: +1 (800) 444-7643 | Fax: +1 (800) 225-2778 | us-customerservice@grohe.com

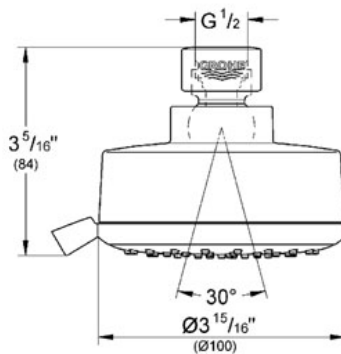

Product Description:
Head shower 4 sprays

Standard Specification:

- GROHE StarLight® finish
- GROHE DreamSpray® perfect spray pattern Ø 4"
- GROHE EcoJoy® technology for less water and perfect flow
- 1/2" Connection thread
- SpeedClean anti-lime system
- Inner WaterGuide for a longer life
- Suitable for instantaneous heater
- GROHE Rain O2, Rain, • Rotating ball joint ± 15°
- Min. recommended pressure 15 psi
- Max Flow Rate 2.5 gpm (9.5 L/min)

Applicable Codes & Standards:

- Energy Policy Act of 1992
- ASME A112.18.1/CSA B125.1

Color:

- 27591 000 chrome
- 27591 EN0 Brushed Nickel

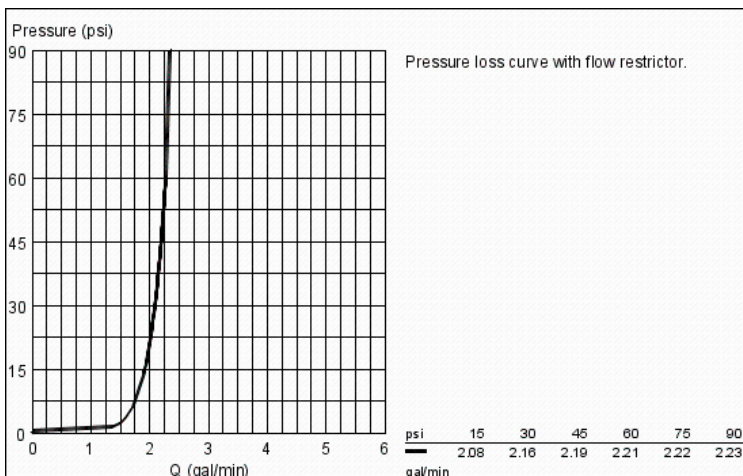

EUROCUBE
Tub Spout
MODEL # 13307

Pure Freude an Wasser



GROHE America, Inc | 200 North Gary Avenue, Suite G, Roselle, IL 60172
Phone: +1 (800) 444-7643 | Fax: +1 (800) 225-2778 | us-customerservice@grohe.com

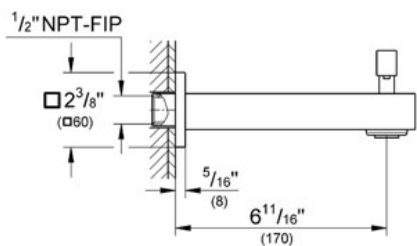

ADA

Product Description:
Tub Spout

Standard Specification:

- GROHE StarLight® finish
- Wall mount
- Flow control
- Automatic diverter: bath/shower
- 1/2" NPT Female thread
- Projection 6 11/16"
- Max FLOW Rate 6.9 gpm at 45 psi (26.1 L/min),
2.5 gpm (9.5 L/min) for Shower Hand

Applicable Codes & Standards:

- Energy Policy Act of 1992
- ASME A112.18.1/CSA B125.1
- US Federal and State material regulations
- ICC/ANSI A117.1

Color:

- 13307 000 chrome