

RAINSHOWER® GRANDERA™ Shower Arm 11 1/4" NPT

MODEL # 27988

Pure Freude an Wasser

GROHE

GROHE America, Inc | 200 North Gary Avenue, Suite G, Roselle, IL 60172
Phone: +1 (800) 444-7643 | Fax: +1 (800) 225-2778 | us-customerservice@grohe.com

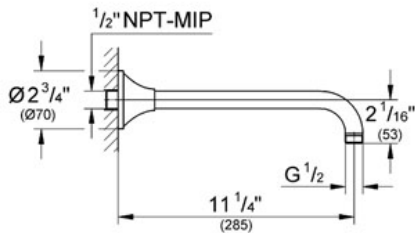
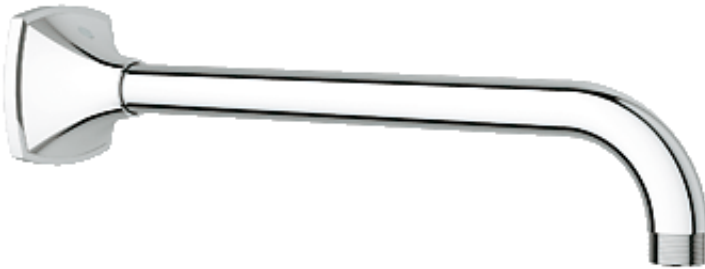

Product Description: Shower Arm 11 1/4" NPT

Standard Specification:

- GROHE StarLight® finish
- Grandera™ escutcheon
- Suitable for all Grandera™ head showers
- Metal
- Connection thread 1/2" NPT

Applicable Codes & Standards:

- Energy Policy Act of 1992
- ASME A112.18.1/CSA B125.1

Color:

- 27988 000 chrome
- 27988 EN0 Brushed Nickel

RAINSHOWER® F-SERIES 5" Body Spray

MODEL # 27252

Pure Freude an Wasser



GROHE America, Inc | 200 North Gary Avenue, Suite G, Roselle, IL 60172
Phone: +1 (800) 444-7643 | Fax: +1 (800) 225-2778 | us-customerservice@grohe.com

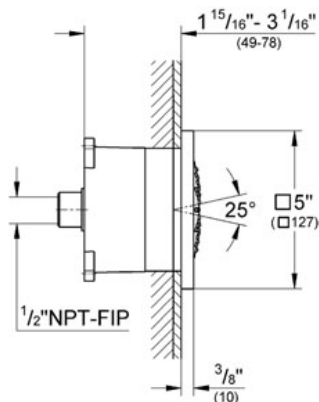

Product Description: Body Spray

Standard Specification:

- GROHE StarLight® finish
- GROHE DreamSpray® perfect spray pattern
- GROHE FlowBalance flow regulating screw
- SpeedClean anti-lime system
- 1 Spray: Normal
- GROHE EcoJoy® 2.4 g flow limiter
- Includes concealed body
- Can also be used as a head shower
- 5" x 5"
- Flow straightener with ball joint ($\pm 12.5^\circ$ rotatable)
- 1/2" NPT Female thread
- Suitable for instantaneous heater
- Max Flow Rate 2.5 gpm at 80 psi (9.5 L/min)

Applicable Codes & Standards:

- Energy Policy Act of 1992
- ASME A112.18.1/CSA B125.1

Color:

- 27252 000 chrome
- 27252 KS0 velvet black
- 27252 LS0 moon white

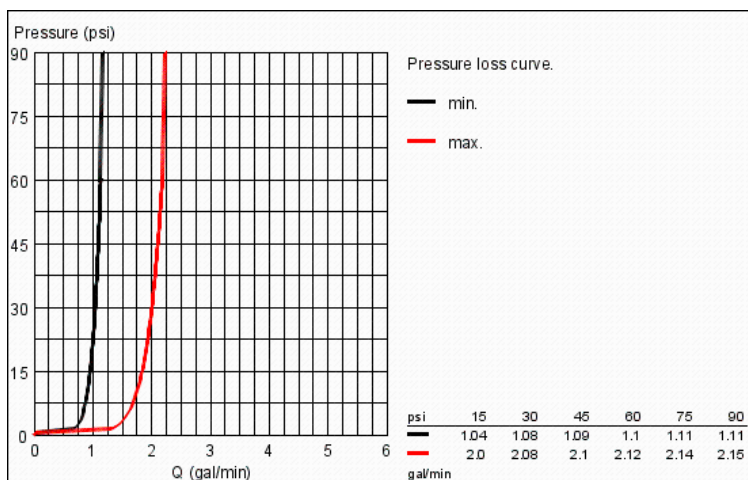

GRANDERA
Shower outlet elbow
MODEL # 27971

Pure Freude an Wasser



GROHE America, Inc | 200 North Gary Avenue, Suite G, Roselle, IL 60172
Phone: +1 (800) 444-7643 | Fax: +1 (800) 225-2778 | us-customerservice@grohe.com



Product Description:
Shower outlet elbow

Standard Specification:

- GROHE StarLight® finish
- Connection thread 1/2" NPT

Applicable Codes & Standards:

- Energy Policy Act of 1992
- ASME A112.18.1/CSA B125.1

Color:

- 27971 000 chrome
- 27971 EN0 Brushed Nickel

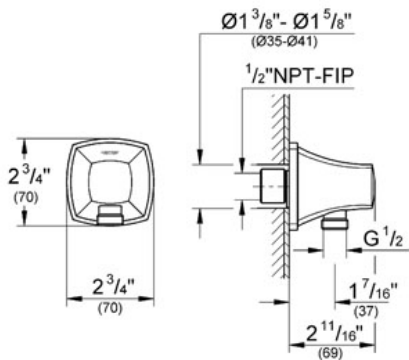

ROTAFLEX METAL LONGLIFE Metal Shower Hose

MODEL # 28417

Pure Freude an Wasser



GROHE America, Inc | 200 North Gary Avenue, Suite G, Roselle, IL 60172
Phone: +1 (800) 444-7643 | Fax: +1 (800) 225-2778 | us-customerservice@grohe.com

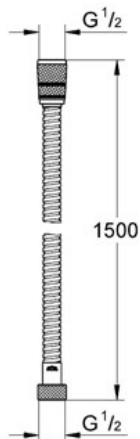

Product Description: Metal Shower Hose

Standard Specification:

- GROHE StarLight® finish
- Longlife
- Strengthened model
- **Tensile strength 750N**
- Rotation cone for Twistfree-function
- Silicone strip prevents hand shower from turning while in body pray position
- 59"

Color:

- 28417 000 chrome
- 28417 ZB0 Oil Rubbed Bronze
- 28417 BE0 Sterling inf
- 28417 EN0 Brushed Nickel

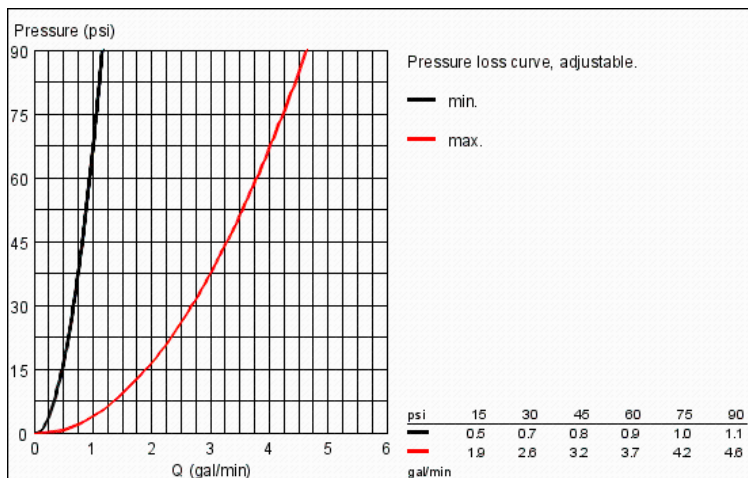

GRANDERA™ STICK Hand Shower

MODEL # 26037

Pure Freude an Wasser



GROHE America, Inc | 200 North Gary Avenue, Suite G, Roselle, IL 60172
Phone: +1 (800) 444-7643 | Fax: +1 (800) 225-2778 | us-customerservice@grohe.com

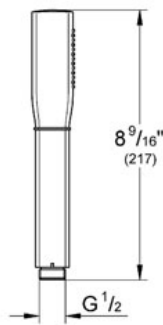

Product Description: Hand Shower

Standard Specification:

- GROHE StarLight® finish
- GROHE EcoJoy® 2.0g flow limiter
- GROHE CoolTouch No risk of scalding
- GROHE DreamSpray® perfect spray pattern
- SpeedClean anti-lime system
- Inner WaterGuide for a longer life
- Spray pattern: Rain
- Metal
- Suitable for instantaneous heater
- Universal mounting system (fits all standard shower hoses)
- Min. recommended pressure 15 psi
- Max Flow Rate 2.0 gpm (7.6 L/min)

Applicable Codes & Standards:

- Energy Policy Act of 1992
- ASME A112.18.1/CSA B125.1
- EPA WaterSense®

Color:

- 26037 000 chrome
- 26037 EN0 Brushed Nickel

GROHFLEX™
 Universal Rough-In Box
 MODEL # 35026

Pure Freude an Wasser



GROHE America, Inc | 200 North Gary Avenue, Suite G, Roselle, IL 60172
 Phone: +1 (800) 444-7643 | Fax: +1 (800) 225-2778 | us-customerservice@grohe.com

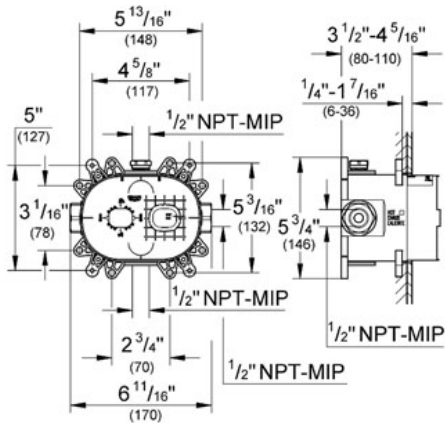
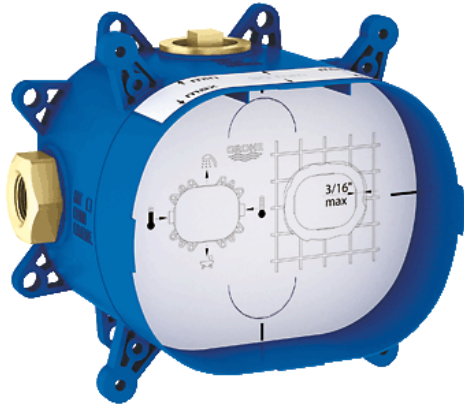

Product Description:
 Universal Rough-In Box

Standard Specification:

- Inlets and outlets 1/2"
- Fixing points for front and back wall
- Leakproof housing
- Integrated service stops
- Flushing plug
- Removable protection cover with installation information
- For use with the GrohFlex Bathroom Solution Kits (sold separately):
 - Pressure Balance Valves and Thermostats
 - Single Function, Dual Function or Custom Shower

Applicable Codes & Standards:

- Energy Policy Act of 1992
- ASME A112.18.1/CSA B125.1

Color:

□ 35026 000

RAINSHOWER® GRANDERA™ 210

MODEL # 27976

Pure Freude an Wasser



GROHE America, Inc | 200 North Gary Avenue, Suite G, Roselle, IL 60172
Phone: +1 (800) 444-7643 | Fax: +1 (800) 225-2778 | us-customerservice@grohe.com

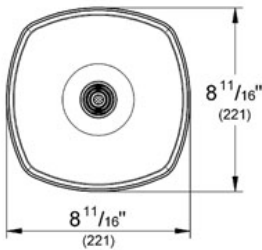
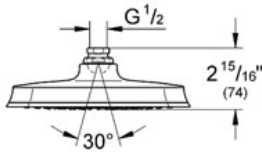

Product Description:

Standard Specification:

- GROHE StarLight® finish
- GROHE EcoJoy® 2.4 g flow limiter
- GROHE DreamSpray® perfect spray pattern
- SpeedClean anti-lime system
- Metal
- Suitable for instantaneous heater
- Rain
- Min. recommended pressure 15 psi

Applicable Codes & Standards:

- Energy Policy Act of 1992
- ASME A112.18.1/CSA B125.1
- CalGreen

Color:

- 27976 000 chrome
- 27976 EN0 Brushed Nickel

GRANDERA

Custom shower thermostatic trim with control module

MODEL # 19940

Pure Freude an Wasser



GROHE America, Inc | 200 North Gary Avenue, Suite G, Roselle, IL 60172
 Phone: +1 (800) 444-7643 | Fax: +1 (800) 225-2778 | us-customerservice@grohe.com

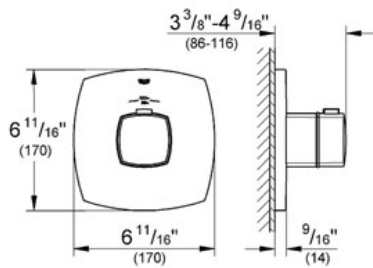

Product Description:

Custom shower thermostatic trim with control module

Standard Specification:

- GROHE TurboStat® technology
- For use with GrohFlex™ universal rough-in box 35 026 000 sold separately
- For high-flow, multiple outlet custom shower applications
- Requires separate volume controls
- Max Flow Rate: 14 gpm at 45 psi
- Min. recommended pressure 15 psi

Applicable Codes & Standards:

- Energy Policy Act of 1992
- ASME A112.18.1/CSA B125.1

Color:

- 19940 000 chrome
- 19940 EN0 Brushed Nickel

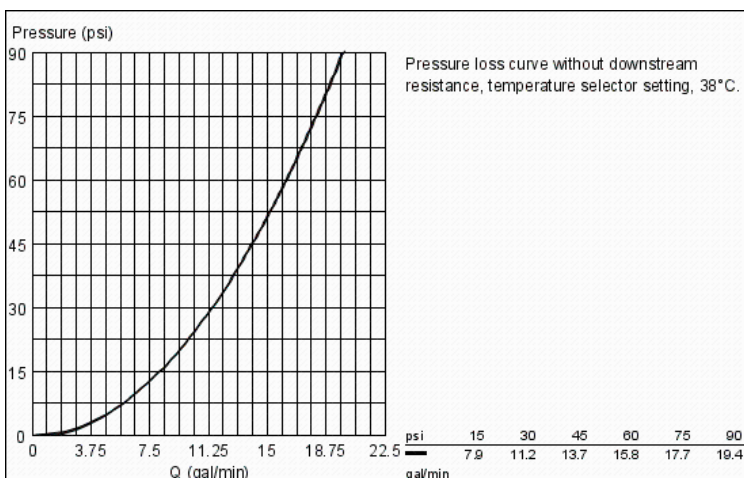

GRANDERA
Volume Control Trim
MODEL # 19944

Pure Freude an Wasser



GROHE America, Inc | 200 North Gary Avenue, Suite G, Roselle, IL 60172
Phone: +1 (800) 444-7643 | Fax: +1 (800) 225-2778 | us-customerservice@grohe.com

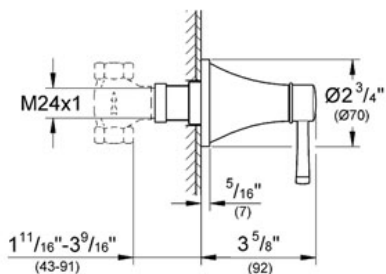

ADA

Product Description:
Volume Control Trim

Standard Specification:

- GROHE StarLight® finish
- For use with Rough-in Valve (35029)

Applicable Codes & Standards:

- Energy Policy Act of 1992
- ASME A112.18.1/CSA B125.1
- ICC/ANSI A117.1

Color:

- 19944 000 chrome
- 19944 EN0 Brushed Nickel

Concealed stop-valve, 1/2"

MODEL # 29273

Pure Freude an Wasser



GROHE America, Inc | 200 North Gary Avenue, Suite G, Roselle, IL 60172
Phone: +1 (800) 444-7643 | Fax: +1 (800) 225-2778 | us-customerservice@grohe.com

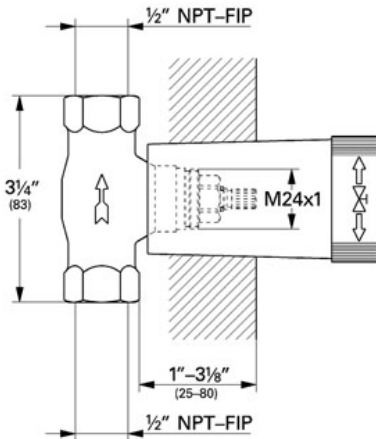

Product Description:
Concealed stop-valve, 1/2"

Standard Specification:

- 1/2" Threaded union
- 1/2" NPT Male Threads

Applicable Codes & Standards:

- Energy Policy Act of 1992
- ASME A112.18.1/CSA B125.1

Color:
 29273 000

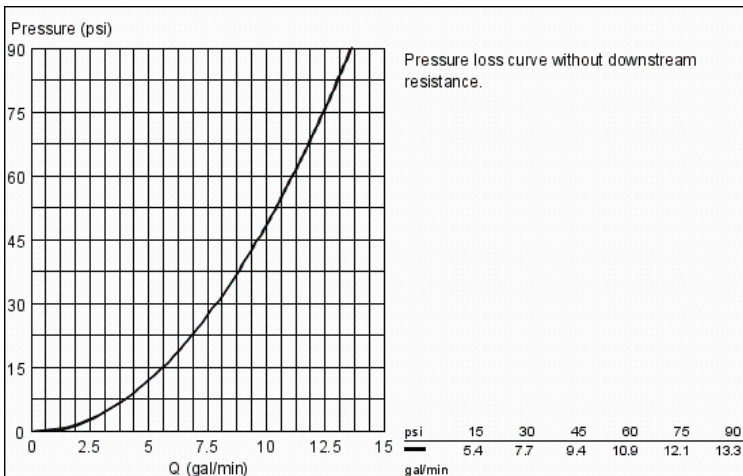

GRANDERA Wall Hand Shower Holder

MODEL # 27969

Pure Freude an Wasser

GROHE

GROHE America, Inc | 200 North Gary Avenue, Suite G, Roselle, IL 60172
Phone: +1 (800) 444-7643 | Fax: +1 (800) 225-2778 | us-customerservice@grohe.com



Product Description:
Wall Hand Shower Holder

Standard Specification:

- Metal
- GROHE StarLight® finish

Applicable Codes & Standards:

- Energy Policy Act of 1992
- ASME A112.18.1/CSA B125.1

Color:

- 27969 000 chrome
- 27969 EN0 Brushed Nickel

