

# 5 5/8" Tubular Shower Arm

MODEL # 27414

*Pure Freude an Wasser*



GROHE America, Inc | 200 North Gary Avenue, Suite G, Roselle, IL 60172  
Phone: +1 (800) 444-7643 | Fax: +1 (800) 225-2778 | us-customerservice@grohe.com



**Product Description:**  
5 5/8" Tubular Shower Arm

**Standard Specification:**

- GROHE StarLight® finish
- 1/2" Connection thread
- Projection 5 5/8"

**Applicable Codes & Standards:**

- Energy Policy Act of 1992
- ASME A112.18.1/CSA B125.1

**Color:**

- 27414 000 chrome
- 27414 EN0 Brushed Nickel

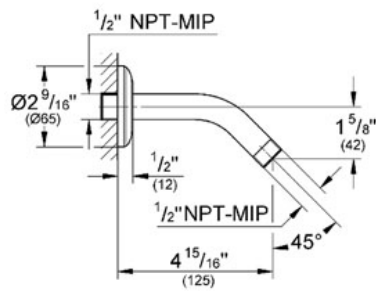

# EUPHORIA CUBE+ STICK Shower Set

MODEL # 27891

*Pure Freude an Wasser*

**GROHE**

GROHE America, Inc | 200 North Gary Avenue, Suite G, Roselle, IL 60172  
Phone: +1 (800) 444-7643 | Fax: +1 (800) 225-2778 | us-customerservice@grohe.com

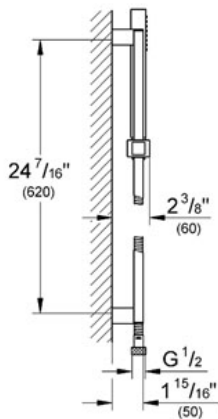

## Product Description: Shower Set

### Standard Specification:

- GROHE StarLight® finish
- GROHE DreamSpray® perfect spray pattern
- GROHE CoolTouch®
- GROHE EcoJoy® technology for less water and perfect flow
- SpeedClean anti-lime system
- Inner WaterGuide for a longer life
- Suitable for instantaneous heater

### Consisting of:

- Hand shower, metal (27 888 000)
- 24" Shower rail (27 892 000)
- 69" metal shower hose (28 025 000)
- Twistfree to prevent hose from twisting
- Max Flow Rate 2.5 gpm at 80 psi (9.5 L/min)

### Applicable Codes & Standards:

- Energy Policy Act of 1992
- ASME A112.18.1/CSA B125.1

### Color:

- 27891 000 chrome

# EUROCUBE

## Dual function pressure balance trim with control module

MODEL # 19925

GROHE America, Inc | 200 North Gary Avenue, Suite G, Roselle, IL 60172  
 Phone: +1 (800) 444-7643 | Fax: +1 (800) 225-2778 | us-customerservice@grohe.com

Pure Freude an Wasser

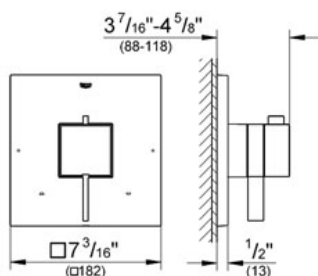

**Product Description:**  
 Dual function pressure balance trim with control module

- Standard Specification:**
- GROHE SilkMove®
  - GROHE StarLight® finish
  - For shower/tubs with non-diverter tub spout or for 2 shower outlet applications
  - Integrated volume control
  - 2-way diverter function
  - 1 axis operation
  - For use with GrohFlex™ universal rough-in box 35 026 000 sold separately
  - 5.3 gpm at 45 psi (bottom outlet)
  - 2.9 gpm at 45 psi (top outlet)
  - Metal trim plate

- Applicable Codes & Standards:**
- Energy Policy Act of 1992
  - ASME A112.18.1/CSA B125.1
  - US Federal and State material regulations

**Color:**  
 19925 000 chrome

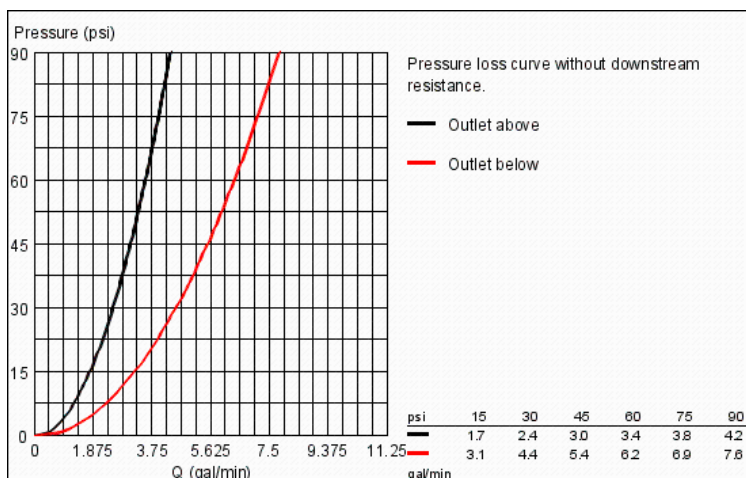

GROHFLEX™  
 Universal Rough-In Box  
 MODEL # 35026

Pure Freude an Wasser



GROHE America, Inc | 200 North Gary Avenue, Suite G, Roselle, IL 60172  
 Phone: +1 (800) 444-7643 | Fax: +1 (800) 225-2778 | us-customerservice@grohe.com

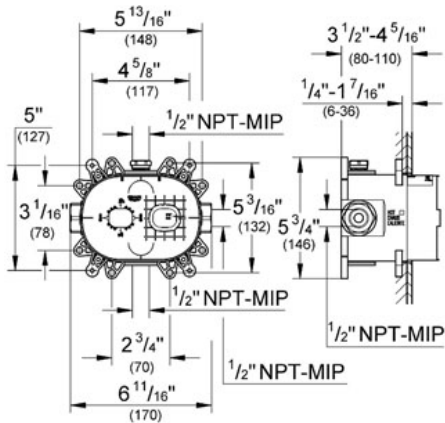
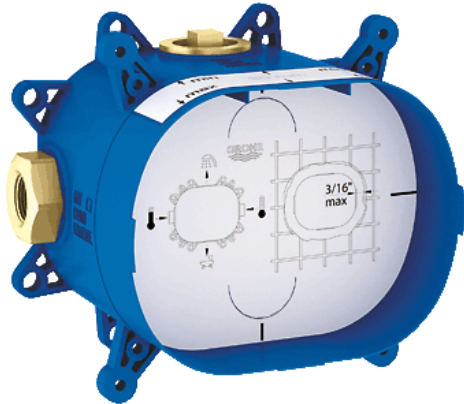

**Product Description:**  
 Universal Rough-In Box

**Standard Specification:**

- Inlets and outlets  $1/2''$
- Fixing points for front and back wall
- Leakproof housing
- Integrated service stops
- Flushing plug
- Removable protection cover with installation information
- For use with the GrohFlex Bathroom Solution Kits (sold separately):
  - Pressure Balance Valves and Thermostats
  - Single Function, Dual Function or Custom Shower

**Applicable Codes & Standards:**

- Energy Policy Act of 1992
- ASME A112.18.1/CSA B125.1

**Color:**

□ 35026 000

NEW TEMPESTA  
COSMOPOLITAN 100  
Head shower 4 sprays  
MODEL # 27591

Pure Freude an Wasser



GROHE America, Inc | 200 North Gary Avenue, Suite G, Roselle, IL 60172  
Phone: +1 (800) 444-7643 | Fax: +1 (800) 225-2778 | us-customerservice@grohe.com

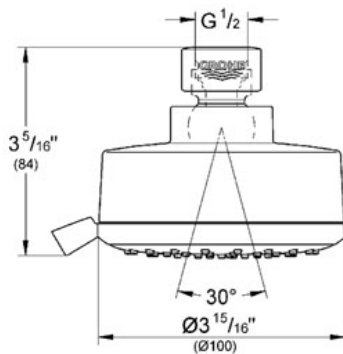

**Product Description:**  
Head shower 4 sprays

**Standard Specification:**

- GROHE StarLight® finish
- GROHE DreamSpray® perfect spray pattern Ø 4"
- GROHE EcoJoy® technology for less water and perfect flow
- 1/2" Connection thread
- SpeedClean anti-lime system
- Inner WaterGuide for a longer life
- Suitable for instantaneous heater
- GROHE Rain O2, Rain, • Rotating ball joint ± 15°
- Min. recommended pressure 15 psi
- Max Flow Rate 2.5 gpm (9.5 L/min)

**Applicable Codes & Standards:**

- Energy Policy Act of 1992
- ASME A112.18.1/CSA B125.1

**Color:**

- 27591 000 chrome
- 27591 EN0 Brushed Nickel

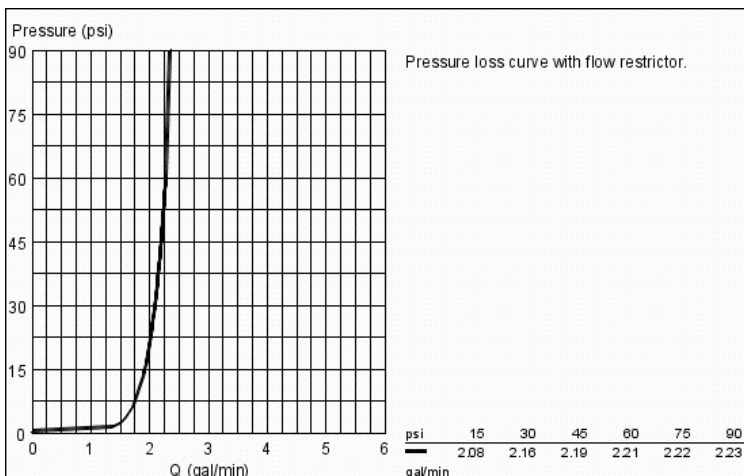

EUROCUBE  
Tub Spout  
MODEL # 13307

Pure Freude an Wasser



GROHE America, Inc | 200 North Gary Avenue, Suite G, Roselle, IL 60172  
Phone: +1 (800) 444-7643 | Fax: +1 (800) 225-2778 | us-customerservice@grohe.com

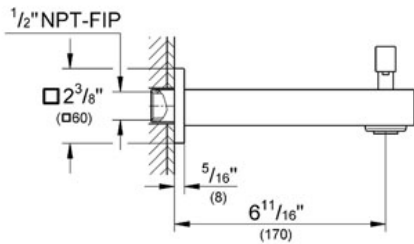

**Product Description:**  
Tub Spout

**Standard Specification:**

- GROHE StarLight® finish
- Wall mount
- Flow control
- Automatic diverter: bath/shower
- 1/2" NPT Female thread
- Projection 6 11/16"
- Max FLOW Rate 6.9 gpm at 45 psi (26.1 L/min),  
2.5 gpm (9.5 L/min) for Shower Hand

**Applicable Codes & Standards:**

- Energy Policy Act of 1992
- ASME A112.18.1/CSA B125.1
- US Federal and State material regulations
- ICC/ANSI A117.1

**Color:**

- 13307 000 chrome

# ALLURE BRILLIANT Shower outlet elbow

MODEL # 27708

*Pure Freude an Wasser*



GROHE America, Inc | 200 North Gary Avenue, Suite G, Roselle, IL 60172  
Phone: +1 (800) 444-7643 | Fax: +1 (800) 225-2778 | us-customerservice@grohe.com



**Product Description:**  
Shower outlet elbow

**Standard Specification:**

- GROHE StarLight® finish
- 1/2" NPT Male Threads
- Protected against backflow

**Applicable Codes & Standards:**

- Energy Policy Act of 1992
- ASME A112.18.1/CSA B125.1

**Color:**

- 27708 000 chrome

