

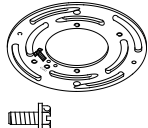





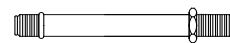

Fixture Name: Madera 1821-FM BI

This fixture assembled PO: _____ Date: _____

Notice: Please review the parts listing and check for all parts before assembling the fixture. If any parts are missing or damaged, please note on this sheet and contact the place of purchase to arrange for replacement parts.

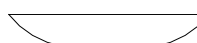
PARTS LIST		Company Name: _____ Co. Account #: _____ to be filled out by retailer	
Mounting Strap 1ea L4**H1.5mm 	Mounting screw 4ea 8/32-IP*H1" 	Stem With Hex Nut 1ea @3/8 x 110mm 	
Hex nut 1ea / 2ea 3/8-IP*H3mm / 8/32-IP*H3mm 	Wire connector 3 ea P4 Orange 	Deco Nut 2ea 12mmx 11mm 	
Bottom cap 1ea Φ75*H14mm 	Finial 1ea 3/8-IP*H14mm 	Flat Washer/Rubber Washer 1ea/2ea @1-1/2" x 2mm 	
Part Needed _____		Quantity _____	
Part Needed _____		Quantity _____	
Reason why (missing, scratched, broken glass, bent, bad finish)			
Comments _____			

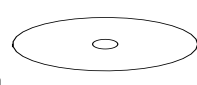
FIXTURE ASSEMBLY INSTRUCTIONS

Read and review installation instruction sheet before assembling the fixture.

1. Thread the Stem With Hex Nut (G) into the Coupling of the Ceiling Pan (F) until tight.
2. Install the lighting bulbs in accordance with the fixture's specification.
3. Place the Flat Washer (H), Rubber Washer (I), Glass Shade (J), Rubber Washer (I), Scrolled cage (K) over the Stem (G) and thread Hex Nut (L) on until tight.
4. Slide Bottom Cap (M) over Stem With Hex Nut (G) and thread the Finial (N) until tight.

(DO NOT EXCEED MAXIMUM WATTAGE RATING!)
NOTE: INSTALL THE GLASS ASSEMBLY AFTER THE FIXTURE IS HUNG.

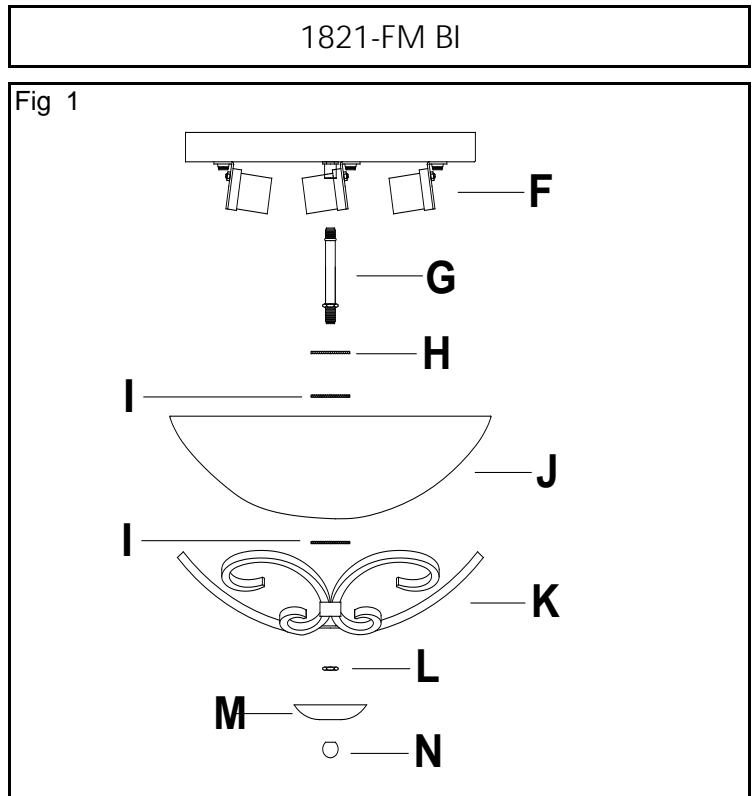

WARNING ! SHUT OFF POWER AT FUSE OR CIRCUIT BREAKER.

HANGING THE FIXTURE (Fig. 1)

1. Carefully remove the new fixture from the carton and the yellow bag that holds all your parts. Check that all parts are included as shown in the illustration and parts list.
2. Shut off power at the circuit breaker and remove the old fixture from wall, including the old mounting strap.
3. The Mounting Strap (B) contains several pairs of threaded holes. Find the pair of holes that matches the holes spacing in your Canopy (F) and thread the two Mounting Screws (A) into the Mounting Strap (B). Secure in place with Hex nuts (D).
4. Place the Mounting Strap (B) over the junction box so the Mounting Screws (A) will have their threaded ends protrude through the two holes in the canopy (F).
5. Attach the Mounting Strap (B) to the junction box by using the two Mounting Screws (C). Tighten the screws securely.

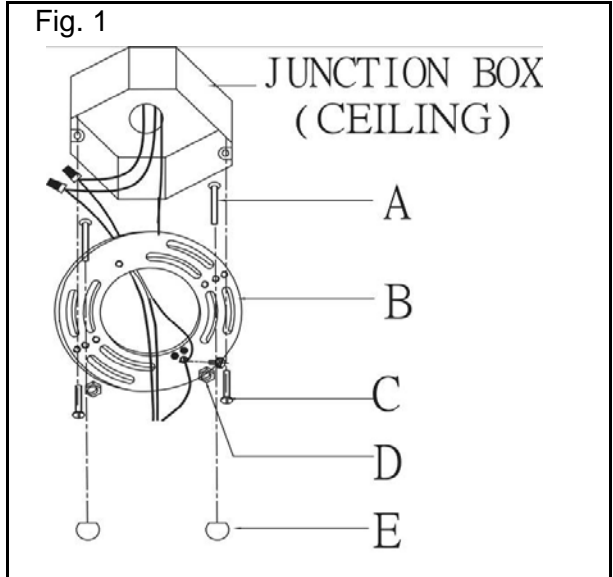

CONNECTING THE WIRES (Fig. 2)

6. Take the black wire from the ceiling junction box and the smooth wire leg from the fixture and twist bare ends together. Twist wire connector onto end of wires until snug.
 7. Repeat same process with white junction box wire and ribbed wire of fixture.
- NOTE:** Twist wires together in the same direction you twist the wire connector onto wires.
8. If your junction box has a grounding wire (green or bare copper), attach this wire and the bare copper wire from the fixture together as in step 7. If junction box has no ground wire, attach the bare copper fixture wire to the junction box with a screw.
 9. Tuck these wire connections neatly into the junction box.

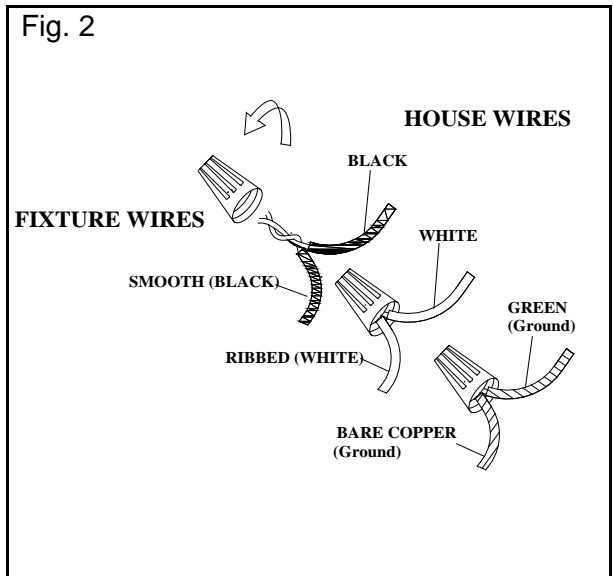

FINISHING THE INSTALLATION (Fig. 3)

10. Place the fixture's Canopy (F) over the Mounting Strap (B) and over the Mounting Screws (A). Adjust the fixture canopy until the Mounting Screws (A) protrude out from the canopy. Secure the fixture against the ceiling by threading the Decorative Nuts (E) on until tight.
 11. Install the light bulbs and glass shade according to the fixture assembly sheet
- YOUR INSTALLATION IS NOW COMPLETE.**
RETURN POWER TO THE JUNCTION BOX AND TEST THE FIXTURE.

