







Fixture Name: Pemberley Court 1089-BA3 RSB

This fixture assembled PO: \_\_\_\_\_ Date: \_\_\_\_\_

**Notice:** Please review the parts listing and check for all parts before assembling the fixture. If any parts are missing or damaged, please note on this sheet and contact the place of purchase to arrange for replacement parts.

<b>PARTS LIST</b>		Company Name: _____ Co. Account #: _____	
below to be filled out by retailer			
Mounting Strap 1ea 4"X3" 	Junction Box Screw 2ea 8/32"X1" 	Mounting Screw 2ea 8/32"X28mm 	
Wire Connector 3ea P4 Orange 	Hex Nut 2ea 8/32"X3.5mm 	Deco Nut (round nut) 2ea 9X9.5mm 	
Green Ground Screw 1ea 8/32"X10mm 			
Part Needed _____	Quantity _____		
Part Needed _____	Quantity _____		
Reason why _____	( missing, scratched, broken glass, bent, bad finish)		
Comments _____			

## FIXTURE ASSEMBLY INSTRUCTIONS

Read and review installation instruction sheet before assembling the fixture.

- Slide the Glass Shade (H) over Socket (I) and secure Glass Shade (H) by threading the Socket Ring (J) to Socket (I)
- Install light bulb in accordance with fixture's specifications.

(DO NOT EXCEED THE MAXIMUM WATTAGE RATING!)

**NOTE: INSTALL THE GLASS ASSEMBLY AFTER THE FIXTURE IS HUNG.**

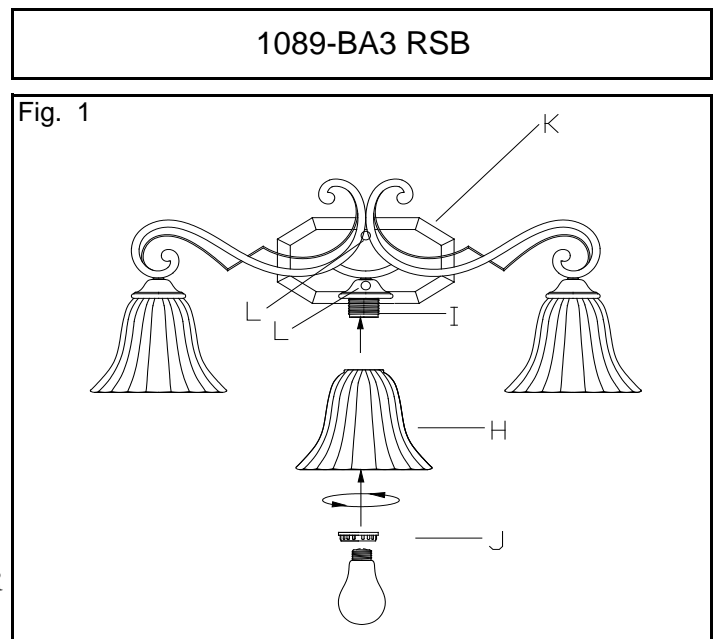

For Customer Service, contact the place of purchase to arrange for replacement parts.

## WARNING ! SHUT OFF POWER AT FUSE OR CIRCUIT BREAKER.

### HANGING THE FIXTURE (Fig. 1)

1. Carefully remove the new fixture from the carton and the yellow bag that holds all your parts. Check that all parts are included as shown in the illustration and parts list.
2. Shut off power at the circuit breaker and remove the old fixture from wall, including the old mounting strap.
3. The Mounting Strap(A) contains several pairs of threaded holes, find the pair of holes that match the holes spacing in your fixture Back Plate (K) and thread the two Mounting Screws(B) half way into the Mounting Strap(A).
4. Place the Mounting Strap (A) over the Junction Box (E) so the Mounting Screws (B) are vertical or horizontal, as required by fixture type.
5. Attach the Mounting Strap (A) to the Junction Box (E) by using the two mounting screws(D). Tighten the screws securely.

### CONNECTING THE WIRES (Fig. 2)

6. Attach the power supply wires to the fixture lead wires by connecting BLACK to BLACK (or SMOOTH) and WHITE to WHITE (or RIBBED).
7. Attach the GROUND wire(GREEN or COPPER) from the Junction Box and the fixture Ground wire to the green Ground Screw on the Mounting Bracket (A) or connect both wires together using the correct size of wire connectors.

NOTE: Twist the wires together in the same direction you twist the wire connector onto the wires.

8. Tuck these wire connections neatly into the Junction Box.

### FINISHING THE INSTALLATION (Fig. 3)

9. Place the fixture Back Plate (K), over the Mounting screws(B), so they protrude through the holes in the Back Plate (K).
10. Thread the Deco Nuts (L) onto the Mounting Screws (B) and continue turning until the Back Plate (K) is snug against the wall.
11. Install glass as per the fixture assembly instructions

YOUR INSTALLATION IS NOW COMPLETE. RETURN POWER TO THE JUNCTION BOX AND TEST THE FIXTURE.

Fig. 1

## JUNCTION BOX

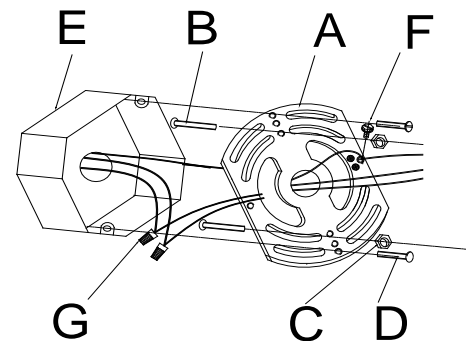

Fig. 2

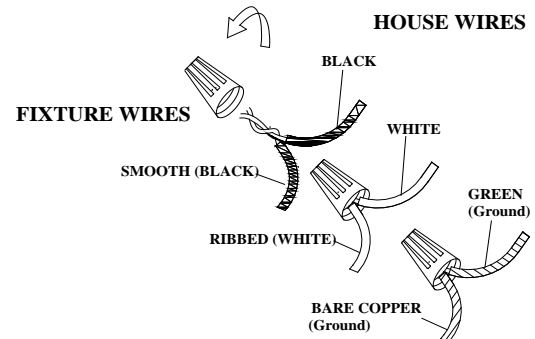

Fig. 3

